

IAEA-TECDOC-1695

***Application of  
Isotope Techniques for  
Assessing Nutrient Dynamics in  
River Basins***



**IAEA**

International Atomic Energy Agency

APPLICATION OF ISOTOPE  
TECHNIQUES FOR ASSESSING  
NUTRIENT DYNAMICS  
IN RIVER BASINS

The following States are Members of the International Atomic Energy Agency:

AFGHANISTAN	GUATEMALA	PANAMA
ALBANIA	HAITI	PAPUA NEW GUINEA
ALGERIA	HOLY SEE	PARAGUAY
ANGOLA	HONDURAS	PERU
ARGENTINA	HUNGARY	PHILIPPINES
ARMENIA	ICELAND	POLAND
AUSTRALIA	INDIA	PORTUGAL
AUSTRIA	INDONESIA	QATAR
AZERBAIJAN	IRAN, ISLAMIC REPUBLIC OF	REPUBLIC OF MOLDOVA
BAHRAIN	IRAQ	ROMANIA
BANGLADESH	IRELAND	RUSSIAN FEDERATION
BELARUS	ISRAEL	RWANDA
BELGIUM	ITALY	SAUDI ARABIA
BELIZE	JAMAICA	SENEGAL
BENIN	JAPAN	SERBIA
BOLIVIA	JORDAN	SEYCHELLES
BOSNIA AND HERZEGOVINA	KAZAKHSTAN	SIERRA LEONE
BOTSWANA	KENYA	SINGAPORE
BRAZIL	KOREA, REPUBLIC OF	SLOVAKIA
BULGARIA	KUWAIT	SLOVENIA
BURKINA FASO	KYRGYZSTAN	SOUTH AFRICA
BURUNDI	LAO PEOPLE'S DEMOCRATIC REPUBLIC	SPAIN
CAMBODIA	LATVIA	SRI LANKA
CAMEROON	LEBANON	SUDAN
CANADA	LESOTHO	SWAZILAND
CENTRAL AFRICAN REPUBLIC	LIBERIA	SWEDEN
CHAD	LIBYA	SWITZERLAND
CHILE	LIECHTENSTEIN	SYRIAN ARAB REPUBLIC
CHINA	LITHUANIA	TAJIKISTAN
COLOMBIA	LUXEMBOURG	THAILAND
CONGO	MADAGASCAR	THE FORMER YUGOSLAV REPUBLIC OF MACEDONIA
COSTA RICA	MALAWI	TOGO
CÔTE D'IVOIRE	MALAYSIA	TRINIDAD AND TOBAGO
CROATIA	MALI	TUNISIA
CUBA	MALTA	TURKEY
CYPRUS	MARSHALL ISLANDS	UGANDA
CZECH REPUBLIC	MAURITANIA	UKRAINE
DEMOCRATIC REPUBLIC OF THE CONGO	MAURITIUS	UNITED ARAB EMIRATES
DENMARK	MEXICO	UNITED KINGDOM OF GREAT BRITAIN AND NORTHERN IRELAND
DOMINICA	MONACO	UNITED REPUBLIC OF TANZANIA
DOMINICAN REPUBLIC	MONGOLIA	UNITED STATES OF AMERICA
ECUADOR	MONTENEGRO	URUGUAY
EGYPT	MOROCCO	UZBEKISTAN
EL SALVADOR	MOZAMBIQUE	VENEZUELA
ERITREA	MYANMAR	VIETNAM
ESTONIA	NAMIBIA	YEMEN
ETHIOPIA	NEPAL	ZAMBIA
FIJI	NETHERLANDS	ZIMBABWE
FINLAND	NEW ZEALAND	
FRANCE	NICARAGUA	
GABON	NIGER	
GEORGIA	NIGERIA	
GERMANY	NORWAY	
GHANA	OMAN	
GREECE	PAKISTAN	
	PALAU	

The Agency's Statute was approved on 23 October 1956 by the Conference on the Statute of the IAEA held at United Nations Headquarters, New York; it entered into force on 29 July 1957. The Headquarters of the Agency are situated in Vienna. Its principal objective is "to accelerate and enlarge the contribution of atomic energy to peace, health and prosperity throughout the world".

APPLICATION OF ISOTOPE  
TECHNIQUES FOR ASSESSING  
NUTRIENT DYNAMICS  
IN RIVER BASINS

## COPYRIGHT NOTICE

All IAEA scientific and technical publications are protected by the terms of the Universal Copyright Convention as adopted in 1952 (Berne) and as revised in 1972 (Paris). The copyright has since been extended by the World Intellectual Property Organization (Geneva) to include electronic and virtual intellectual property. Permission to use whole or parts of texts contained in IAEA publications in printed or electronic form must be obtained and is usually subject to royalty agreements. Proposals for non-commercial reproductions and translations are welcomed and considered on a case-by-case basis. Enquiries should be addressed to the IAEA Publishing Section at:

Marketing and Sales Unit, Publishing Section  
International Atomic Energy Agency  
Vienna International Centre  
PO Box 100  
1400 Vienna, Austria  
fax: +43 1 2600 29302  
tel.: +43 1 2600 22417  
email: [sales.publications@iaea.org](mailto:sales.publications@iaea.org)  
<http://www.iaea.org/books>

For further information on this publication, please contact:

Isotope Hydrology Section  
International Atomic Energy Agency  
Vienna International Centre  
PO Box 100  
1400 Vienna, Austria  
Email: [Official.Mail@iaea.org](mailto:Official.Mail@iaea.org)

© IAEA, 2013  
Printed by the IAEA in Austria  
May 2013

### IAEA Library Cataloguing in Publication Data

Application of isotope techniques for assessing nutrient dynamics in river basins. – Vienna : International Atomic Energy Agency, 2013.  
p. ; 30 cm. – (IAEA-TECDOC series, ISSN 1011-4289; no. 1695)  
ISBN 978-92-0-138810-0  
Includes bibliographical references.

1. Radioisotopes in hydrology – Technique. 2. Water resources development – Management. 3. Stable isotopes.  
I. International Atomic Energy Agency. II. Series.

## FOREWORD

Nutrients are necessary for the growth and survival of animals, plants and other organisms. However, industrial, agricultural and urban development has dramatically increased nutrient levels in river systems — including nitrogen and phosphorus containing substances — degrading water quality, causing acidification and eutrophication, and affecting aquatic ecosystems. Nutrient assessment and management in river systems has been an important part of water resource management for the past few decades, but the provision of appropriate and effective nutrient assessment and management continues to be a challenge for water resource managers and policy makers. Difficulties in assessment and management are due in part to the fact that nutrients in rivers may originate from a variety of sources, take numerous pathways and transform into other substances.

This publication presents the application of isotope techniques as a powerful tool for evaluating the sources, pathways, transformation and fate of nutrients in river systems, focusing on nitrogen, phosphorus and carbon containing substances. Eleven researchers using various isotope techniques for different aspects of nutrient studies and two IAEA officers met in a technical meeting and discussed a publication that could assist water resource managers in dealing with nutrient assessment and management issues in river systems. These researchers also recognized the need for careful consideration in selecting appropriate isotope techniques in view of not only technical, but also financial, human resources and logistical capabilities, among others. This publication aims at serving water resource managers as a guidebook on the application of isotope techniques in nutrient assessment and management, but it is also expected to be a practical aid for other interested and concerned individuals and organizations.

The IAEA officers in charge of the technical meeting were M. Ito and B.D. Newman of the Division of Physical and Chemical Sciences. The IAEA officer responsible for this publication was M. Ito of the Division of Physical and Chemical Sciences.

## *EDITORIAL NOTE*

*The papers in these proceedings are reproduced as submitted by the authors and have not undergone rigorous editorial review by the IAEA.*

*The views expressed do not necessarily reflect those of the IAEA, the governments of the nominating Member States or the nominating organizations.*

*The use of particular designations of countries or territories does not imply any judgement by the publisher, the IAEA, as to the legal status of such countries or territories, of their authorities and institutions or of the delimitation of their boundaries.*

*The mention of names of specific companies or products (whether or not indicated as registered) does not imply any intention to infringe proprietary rights, nor should it be construed as an endorsement or recommendation on the part of the IAEA.*

*The authors are responsible for having obtained the necessary permission for the IAEA to reproduce, translate or use material from sources already protected by copyrights.*

## CONTENTS

### FOREWORD

<b>SUMMARY</b> .....	1
The application of isotope techniques in nutrient assessment and management in riverine systems — present and future .....	7
<i>M. Ito, W.L. Hadwen, K. Rogers, B. Mayer, T. Hein, L. Stellato, N. Ohte, B.D. Newman, K. McLaughlin</i>	
Isotopic assessment of nitrogen cycling in river basins: Potential and limitations for nutrient management purposes .....	15
<i>B. Mayer, M. Sebilo, L.I. Wassenaar</i>	
The benefit of using isotopes in NO <sub>3</sub> water quality management.....	35
<i>D. Widory</i>	
Simultaneous measurement of nitrogen and oxygen isotopes of nitrate to evaluate nitrate sources and processes in catchments .....	49
<i>Nobuhito Ohte, Toshi Nagata, Ichiro Tayasu, Ayato Kyoze, Chikage Yoshimizu, Ken'ichi Osaka</i>	
Using whole stream $\delta^{15}\text{N}$ additions to understand the effects of land use change on stream function .....	69
<i>L.A. Deegan, C. Neill, R.L. Victoria, A.V. Krusche, M.V.R. Ballester, S. Thomas, C. Hauptert</i>	
The oxygen isotopic composition of phosphate: A tracer for phosphate sources and cycling .....	93
<i>K. McLaughlin, M.B. Young, A. Paytan, C. Kendall</i>	
Investigating pathways of nutrient and energy flows through aquatic food webs using stable isotopes of carbon and nitrogen .....	111
<i>W.L. Hadwen, S.E. Bunn</i>	
Using stable isotopes to detect land use change and nitrogen sources in aquatic systems .....	129
<i>K.M. Rogers</i>	
Stable isotope signatures of carbon and nitrogen to characterize exchange processes and their use for restoration projects along the Austrian Danube.....	157
<i>T. Hein, E. Bondar-Kunze, N. Welti</i>	
Physical and human controls on the carbon composition of organic matter in tropical rivers: An integrated analysis of landscape properties and river isotopic composition .....	173
<i>M.V.R. Ballester, R.L. Victoria, A.V. Krusche, M. Bernardes, C. Neill, L. Deegan, J.E. Richey</i>	
Groundwater inputs to rivers: Hydrological, biogeochemical and ecological effects inferred by environmental isotopes .....	187
<i>L. Stellato, B.D. Newman</i>	



The noble gas radon ( $^{222}\text{Rn}$ ) as a hydrogeologic tracer of groundwater inputs to rivers and hyporheic exchange.....	219
<i>L. Stellato, B.D. Newman</i>	
List of participants .....	233

## FOREWORD

Nutrients are necessary for the growth and survival of animals, plants and other organisms. However, industrial, agricultural and urban development has dramatically increased nutrient levels in river systems, including nitrogen and phosphorus containing substances, degrading water quality, causing acidification and eutrophication and affecting aquatic ecosystems. Nutrient assessment and management in river systems has been an important part of water resource management for the past few decades, but the provision of appropriate and effective nutrient assessment and management continues to be a challenge for water resource managers and policy makers. Difficulties in assessment and management are due in part to the fact that nutrients in rivers may originate from a variety of sources, take numerous pathways and transform into other substances.

This publication presents the application of isotope techniques as a powerful tool for evaluating the sources, pathways, transformation, and fate of nutrients in river systems, focusing on nitrogen, phosphorus and carbon containing substances. Eleven researchers using various isotope techniques for different aspects of nutrient studies and two IAEA officers met in a technical meeting and discussed a publication that could assist water resource managers in dealing with nutrient assessment and management issues in river systems. These researchers also recognized the need for careful consideration in selecting appropriate isotope techniques in view of not only technical, but also financial, human resources and logistical capabilities, among others. These contributors are listed as major authors in the later pages of this document. This publication aims at serving water resource managers as a guidebook on the application of isotope techniques in nutrient assessment and management, but it is also expected to be of practical aid for other interested and concerned individuals and organization.

The IAEA officers in charge of the technical meeting were M. Ito and B.D. Newman of the Division of Physical and Chemical Sciences. The IAEA officer responsible for this publication was M. Ito of the Division of Physical and Chemical Sciences.



## SUMMARY

### 1. BACKGROUND

Nutrients are substances or elements necessary for the growth and survival of animals, plants and other organisms. As many as 26 elements are required for biochemical reactions and biomass growth [1]. Nutrients can be introduced to surface and ground waters by natural processes, such as, for example, atmospheric deposition, biological fixation, soil leaching and their subsequent transport mechanisms.

However, industrial, agricultural and urban developments, including an excess use of fertilizers and the increased release of human and animal wastes, have elevated the fluxes of nutrients, such as nitrogen (N) and phosphorus (P) containing substances, into surface and ground waters, and altered the nutrient cycle. The enhanced mobility and availability of nutrients moving through biogeochemical pathways has changed the acidity of waters and soils, or highly stimulated or developed primary producers in the aquatic environment. As seen as an increase in algae (phytoplankton) and the appearance of oxygen depleted zones in surface water, ecological species have changed in abundance and in variety, in some cases transforming the ecosystem structure that they compose. Elevated concentrations of nutrients have also deteriorated water quality, as observed in fresh and coastal waters throughout the world in the past few decades (see, for example, Ref. [2]). Further, inorganic nitrogen in ground and surface waters could induce adverse effects on human health. Nitrate ( $\text{NO}_3^-$ ) has become one of the common contaminants found in groundwater and in public and private water supply systems based on groundwater [3, 4]. Nitrate has been thought to be related to 'blue baby syndrome' or methemoglobinemia, which is an oxygen supply deficiency, especially in infants. Ammonia and nitrite are also toxic, because they are rapidly oxidised in to  $\text{NO}_3^-$  in aerobic conditions. In addition, direct toxicity of some algae can be a threat to aquatic ecosystems.

The management of nutrients entering the aquatic environment was already being discussed in scientific journals at least in the 1970s (see e.g. Ref. [5]). But the need for the assessment of nutrient status in rivers is still one of the priorities for water resource managers and policy makers. For example, nutrients, together with sediments, are among the main water quality issues in the Mississippi River basin in the United States of America [6].

This publication presents the application of isotope techniques as an effective tool for evaluating the sources, pathways, transformation, and fate of nutrients in river systems, focusing on N, P and carbon (C). As mentioned above, two nutrient elements, N and P, are linked to water quality and ecological productivity as well as to the health status of humans and other organisms. Carbon, as a non-nutrient element, constitutes organic matter, which plays an indispensable role in biogeochemical cycling. C supply is also a key to the occurrence of environmentally adverse phenomena, such as eutrophication and hypoxia.

### 2. OBJECTIVE

The objective of this publication is to assist water resource managers in applying isotope techniques to effectively manage nutrient issues in river systems. In this publication, the application

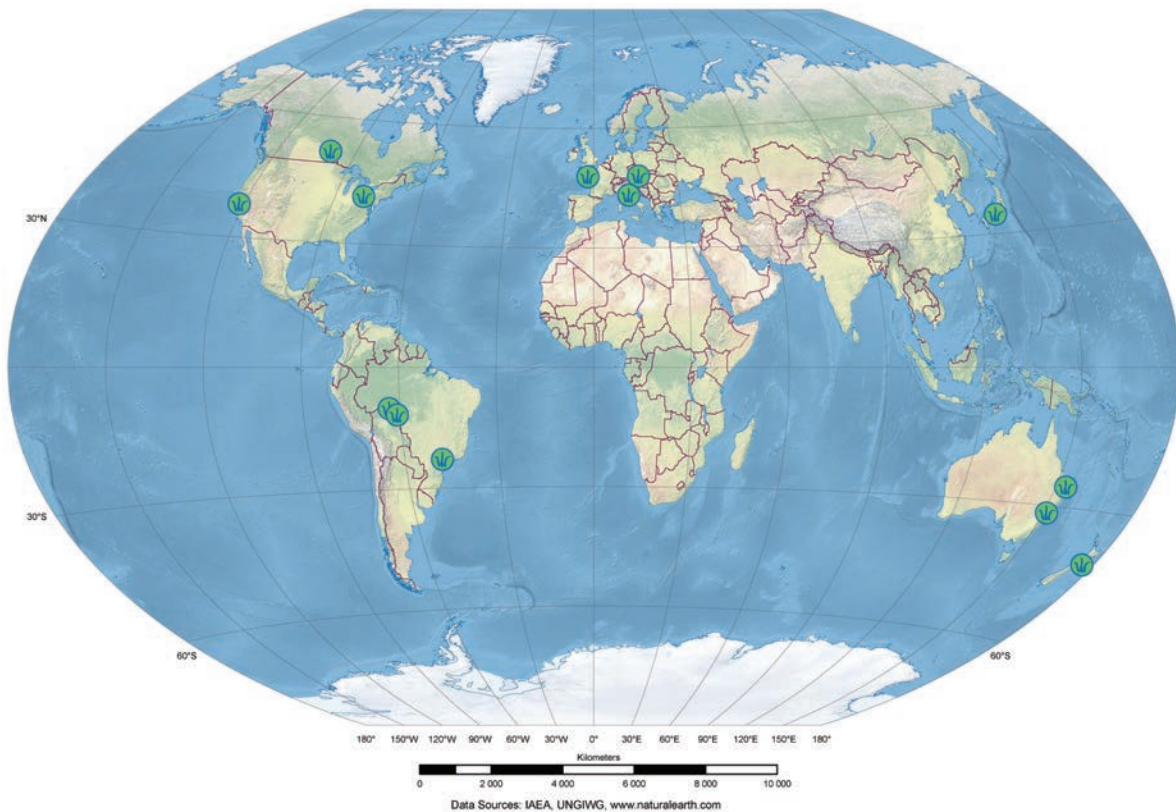

*FIG. 1. Location of study sites presented in this publication.*

of different isotope techniques are presented to evaluate the sources, pathways, transformation, and fate of nutrients, focusing on N, P and C, in various river systems in the world (Fig. 1).

### **3. SCOPE**

The scope of this publication is to serve as a guidebook for water resource managers, but it would also be helpful for other interested and concerned individuals and organizations in conducting nutrient studies and management in river systems.

### **4. STRUCTURE**

The first chapter reviews representative isotope types and roles of isotope techniques in nutrient assessment and management, presents the technical, financial and logistical considerations required for the application of isotope techniques, and proposes several approaches in the application of isotope techniques in nutrient studies and management for use in the near future. The subsequent chapters by Mayer et al., Ohte et al., Widory, and Deegan et al. investigate nitrate ( $\text{NO}_3^-$ ) flow or critical aspects of the N cycle, using N and other isotopes. For P, McLaughlin et al. evaluate the oxygen isotopic composition of dissolved inorganic phosphate as a tracer in the examination of phosphorus sources and cycling in rivers. Ballester et al., Hadwen and Bunn, Rogers, and Hein et al. differentiate various sources and pathways of nutrients in organic forms with the application of isotope and other techniques. Here, Hadwen and

Bunn also present an overview of nutrient studies on the aquatic food web in rivers. Serving as a review of studies on hydrological and biogeochemical processes in river systems, the first chapter by Stellato and Newman examine the interactions between groundwater and surface water and demonstrate that environmental isotopes are powerful tools for this purpose, when isotope techniques are accompanied by conventional and other methods. Lastly, as an example of the application of noble gas isotopes, the second chapter of Stellato and Newman shows radon isotope ( $^{222}\text{Rn}$ ) to be a hydrogeological tracer of groundwater inputs to rivers and hyporheic exchange.

In summary, this publication is consists of the following parts:

- The application of isotope techniques in nutrient assessment and management — present and future;
- Nitrogen cycling;
- Phosphorus cycling;
- Nutrients in organic forms (land use effects, tracing C&N through foodwebs and other approaches);
- Interaction between groundwater and surface water;
- The application of noble gas isotope.

## **5. ACHIEVEMENTS**

This publication demonstrates that the application of isotope techniques can uncover valuable information, as described below (5.1–5.4), which might otherwise be impossible or difficult to obtain, for use in the nutrient management of river systems. This publication also shows that since different information can be obtained through the application of different isotope techniques, careful consideration is needed to select the appropriate isotope techniques, including taking into consideration technical, financial, human resources, and logistical conditions (5.5).

### **5.1. Identification of nutrient sources**

In order to solve or prevent problems due to excess concentrations or nutrient loads, nutrient sources need to be identified. Point source is defined as any single identifiable source of pollution from which pollutants are discharged [7]. It may be relatively easy to determine proper management actions for controlling point sources, while the identification of effective management options is difficult for non-point sources since various potential sources exist, including agricultural, industrial, municipal, and domestic inputs as well as atmospheric deposition and geological sources. Further, the contributions of these sources to the problem may be both spatially and temporally variable. Isotope applications make use of variations in isotopic ratios. If the isotopic composition of nutrient elements from different sources (end-members) are distinct among each other and the isotopic variability of each end-member is limited, the sources of nutrients, or the contributions of multiple end-members, can be estimated. For example, isotope techniques can be an effective approach to distinguish between different N sources, especially between: (a) agricultural sources (synthetic fertilizers) versus sewage leakage due to rapid urbanization, or (b) atmospheric nitrogen deposition due to a high level of exhaust gas emission versus other sources. Synthetic inorganic fertilizers based on the fixation of atmospheric nitrogen show low  $\delta^{15}\text{N}$  values ( $-4$  to  $+4\%$ ) with some exception, while human and animal wastes are often more enriched in  $\delta^{15}\text{N}$  values [8]. The identification of nutrient

sources could assist water resource managers and policy makers in selecting measures that can directly deal with specific sources or flowpaths of nutrients. Possible options in those cases would include the proper management of particular land use types or control of the application or release of certain chemical compounds, among others.

## **5.2. Identification of flowpaths, transformation and fate of nutrients**

Nutrients as they are, or those produced through the mineralization of organic compounds, for example, enter ground and surface waters and are transported and may be further transformed. Isotopic fractionation occurs at physical, chemical and biological reactions, as nutrients move through pathways. Isotope values can imply possible reactions that nutrients or constituents of nutrients have undergone, suggesting possible flowpaths, transformation and fate. For example, depletion in  $\delta^{13}\text{C}$  can suggest pathways in the shallower soil zone, as opposed to waters flowing through the deeper groundwater, due to isotopic fractionation caused by biological generation of carbonic acid in organic soils [9]. For nitrogen, major processes affecting nitrogen isotopic composition include N-fixation, assimilation (uptake), mineralization, nitrification, volatilisation, sorption/desorption, and denitrification, though the extent of isotope fractionation varies. For example, the denitrification process concurrently increases the values of  $\delta^{15}\text{N}$  and  $\delta^{18}\text{O}$  of residual  $\text{NO}_3^-$  [8], which can be differentiated from the isotope values in  $\text{NO}_3^-$  resulting from the mixing of multiple N sources.

## **5.3. Identification of sources and the movement of water as a carrier of nutrients**

Water that reaches the ground from the atmosphere infiltrates into groundwater, flows on the surface, or moves back to the atmosphere through evaporation. Groundwater is discharged to surface water, with a part released back into the atmosphere through transpiration. Isotope techniques can be applied to trace water as an important carrier of nutrients in the investigation of, for example, groundwater recharge and discharge processes and interconnections between surface and ground waters or among aquifers. In particular, the area of groundwater recharge or relative contributions from different water sources (such as new water or precipitation versus pre-storm, old groundwater, etc.) can be estimated, and the recharge rate and age (residence time) of water be quantified. The information on hydrologic and hydrogeologic processes would thus enable water resource managers to predict the movement of nutrients as solutes in certain conditions. If the solutes are transported with water in a relatively conservative manner or if the transforming characteristics of the nutrients are known in the respective surrounding conditions (for example, aerobic/anaerobic conditions, pH, temperature, etc.), a prediction regarding the severity and the geographic location or the extent to which the population and aquatic ecosystems are affected would be possible.

## **5.4. Examination of the effects of nutrients on aquatic ecosystems**

Some of the issues associated with elevated levels of nutrients in the aquatic environment pertain to the regularity of occurrence and the extent to which the structure and functions of aquatic ecosystems are affected. Isotopes have been used to answer these questions, especially through the simultaneous use of N and C stable isotopes. Nutrients (such as N) and energy (organic matter) for aquatic ecosystems can be derived from external (allochthonous, terrestrial origin) as well as in-stream or within-lake (autochthonous) sources. Carbon stable isotopes are used to directly suggest food sources — whether they are allochthonous or autochthonous, or from different natural or anthropogenic origins — which organisms consume [10]. As isotopic



fractionation of N occurs along the food web, N isotopes can be used to indicate the trophic positions of organisms [11]. Further, experimentally introduced compounds that are enriched in  $^{15}\text{N}$  could aid in tracing N through aquatic food webs (see, for example, Refs [12, 13]). Enriched  $^{15}\text{N}$  compounds could suggest the trophic levels up to which experimentally added nutrients can exert influence. The concentrations of added nutrients can also be controlled or changed to examine the effects of particular concentrations of interest on aquatic ecosystems, as described by Hudwen and Bunn in this publication.

### **5.5. The need for careful consideration, including prerequisite conditions, for the application of isotope techniques**

Isotope techniques are effective when several technical conditions are met, including, for example, that potential sources can be identified and have distinct isotopic compositions. The application of isotope techniques requires further consideration, including initial and continuous commitment and, where necessary or suitable, collaboration in assuring technical, financial and human resources in undertaking field and laboratory activities and the analysis and management of data and relevant information, among others. It is also important to mention that the application of isotope techniques does not solve all questions related to nutrient issues in river systems.

## **REFERENCES**

- [1] SCHLESINGER, W.H., *Biogeochemistry*, Academic Press, San Diego, USA (1991).
- [2] VITOUSEK, P.M., et al., Human alteration of the global nitrogen cycle: Sources and consequences, *Ecol. Appl.* **7** (1997) 737–750.
- [3] NOLAN, B.T., HITT, K.J., RUDDY, B.C., Probability of nitrate contamination of recently recharged ground waters in the conterminous United States, *Environ. Sci. Technol.* **36** 10 (2002) 2138–45.
- [4] NATIONAL RESEARCH COUNCIL, COMMITTEE ON TOXICOLOGY, *Nitrate and Nitrite in Drinking Water*, National Academies Press, Washington, D.C. (1995).
- [5] GRUNDY, R.D., Strategies for control of man-made entrophication, *Environ. Sci. Technol.* **5** 12 (1971) 1184–1190.
- [6] NATIONAL RESEARCH COUNCIL, *Mississippi River Water Quality and the Clean Water Act: Progress, Challenges, and Opportunities*, National Academies Press, Washington, D.C. (2008).
- [7] THE CLEAN WATER ACT (CWA), Title 33 of the United States Code §1251 et seq., principally based on Federal Water Pollution Control Act Amendments of 1972, Public Law 92–500, October 18, 1972.
- [8] KENDALL, C., “Tracing nitrogen sources and cycling in catchments”, *Isotope Tracers in Catchment Hydrology* (KENDALL, C., MCDONNELL, J.J., Eds), Elsevier, Amsterdam (1998) 521–576.



- [9] KENDALL, C., CALDWELL, E.A., “Fundamentals of isotope geochemistry”, *Isotope Tracers in Catchment Hydrology* (KENDALL, C., MCDONNELL, J.J., Eds), Elsevier Science B.V., Amsterdam (1998) Ch. 2.
- [10] FRY, B., *Stable isotope ecology*, Springer, New York, USA (2006).
- [11] CABANA, G., RASMUSSEN, J.B., Modelling food chain structure and contaminant bioaccumulation using stable nitrogen isotopes, *Nature* **372** (1994) 255–257.
- [12] MULLHOLLAND, P. J., et al., Food resources of stream macroinvertebrates determined by natural-abundance stable C and N isotopes and a <sup>15</sup>N tracer addition, *J. N. Am. Benthological Soc.* **19** (2000) 145–157.
- [13] MULLHOLLAND, P.J., et al., Nitrogen cycling in a forest stream determined by a <sup>15</sup>N tracer addition, *Ecol. Monogr.* **70** (2000) 471–493.

# THE APPLICATION OF ISOTOPE TECHNIQUES IN NUTRIENT ASSESSMENT AND MANAGEMENT IN RIVERINE SYSTEMS — PRESENT AND FUTURE

M. ITO<sup>a</sup>, W.L. HADWEN<sup>b</sup>, K. ROGERS<sup>c</sup>, B. MAYER<sup>d</sup>, T. HEIN<sup>e</sup>, L. STELLATO<sup>f</sup>,  
N. OHTE<sup>g</sup>, B.D. NEWMAN<sup>a</sup>, K. McLAUGHLIN<sup>h</sup>

<sup>a</sup> International Atomic Energy Agency,  
Isotope Hydrology Section,  
Vienna, Austria

<sup>b</sup> Australian Rivers Institute,  
Griffith School of Environment,  
Griffith University — Nathan Campus,  
Brisbane, Queensland, Australia

<sup>c</sup> National Isotope Center, GNS Science,  
Lower Hutt, New Zealand

<sup>d</sup> Department of Geoscience,  
University of Calgary,  
Calgary, Alberta, Canada

<sup>e</sup> Wasser Cluster Lunz Interuniversity Center for Aquatic Research,  
Lunz/See, Austria

University of Natural Resources and Applied Life Sciences,  
Institute of Hydrobiology and Aquatic Ecosystem Management,  
Vienna, Austria

<sup>f</sup> Centre for Isotopic Research on Cultural  
and Environmental Heritage (CIRCE),  
Seconda Università degli Studi di Napoli,  
Caserta, Italy

<sup>g</sup> Graduate School of Agricultural and Life Sciences,  
The University of Tokyo,  
Tokyo, Japan

<sup>h</sup> Southern California Coastal Water Research Project,  
Costa Mesa, California, USA

## Abstract

A variety of sources contribute to nutrients in rivers and nutrients may subsequently take various pathways and undergo different transformation processes. We first review representative types of isotopes and the roles of isotope techniques that have been or could be used for nutrient assessment and management. We then present technical, financial and logistical matters to be considered in selecting appropriate isotope techniques for nutrient assessment and management. Lastly we propose several approaches on the application of isotope techniques to make more effective the studies and management of nutrients in rivers in the near future.

## 1. INTRODUCTION

Elevated concentrations of nutrients in rivers and their environmental and human health effects, including eutrophication and hypoxia in receiving ecosystems, are not new problems, as already seen, for example, in the early 1970s [1], and continue to challenge water resource managers. The sources of nutrients in rivers can be diverse, including natural and anthropogenic point and non-point sources, such as atmospheric deposition, soil erosion, industrial and urban wastewater effluents, and fertilizers from agricultural and domestic applications in catchments. Further, nutrients may take various pathways and undergo various transformation processes (such as assimilation) during transport along a river flow path (e.g. [2–4]). Success in dealing with nutrient problems in rivers is highly dependent on technical capabilities for identifying nutrient sources and transformation processes. This knowledge will assist in the selection and undertaking of appropriate measures for mitigation in the context of political, economic and social considerations. The chapters presented in this publication demonstrate that isotopes can be powerful tools for water resource managers to tackle nutrient issues, including, for example, the identification of the sources and fate of nutrients, especially when coupled with other approaches, such as chemical and hydrologic measurements.

## 2. WHICH ISOTOPES ARE APPLIED?

Isotopes can be used for nutrient assessment and management in river systems primarily in two manners as follows. Isotopes can trace waters that transport nutrients; they provide especially useful information when it is important to identify water recharge areas or contributions of multiple water components as carriers of particular nutrients. In this publication, Stellato and Newman [5] showed that the radon isotope ( $^{222}\text{Rn}$ ) is an effective tracer in examining interactions between surface water and groundwater. This isotope can be useful, when combined with other hydrological and biogeochemical measures, in evaluating nutrient sources and flow paths. Other isotopes commonly applied in other hydrological and hydrogeological studies, such as deuterium ( $\delta^2\text{H}$ ) and oxygen stable isotope  $\delta^{18}\text{O}$ , tritium ( $^3\text{H}$ ),  $^{14}\text{C}$  of dissolved organic matter or strontium ( $^{87}\text{Sr}/^{86}\text{Sr}$ ), among others, could also be used to identify or quantify the contributions of different water components (including atmospheric waters, subsurface waters, and deep groundwaters, or the fraction of old and new waters to streams) [6].

A variety of physical, chemical and biological conditions and processes affect pathways, transformation processes and fates of nutrients in rivers. Due to this complexity, isotopes can be used to identify nutrient sources or pathways and trace the fate of nutrients in aquatic systems. Using this approach, isotopes of suitable elements can be determined (a) in their dissolved form in waters, or (b) as constituents of living and non-living materials that exist in, or are related to, waters under examination. Some nutrients are also found in the gas phase, but they are not emphasized here, since their contribution to nutrient problems in river systems is considered to be minimal.

Among the nutrients in rivers which are essential chemicals for the survival and proliferation of microbes, algae, plants, fish, animals and other organisms, nitrogen (N) and phosphorus (P) are key productivity elements that concern the public most, as they are the major causes of eutrophication and hypoxia. Nitrogen and phosphorus occur in different forms in waters, including, for N, nitrate ( $\text{NO}_3^-$ ), nitrite ( $\text{NO}_2^-$ ), ammonia ( $\text{NH}_4^+$ ) and organic nitrogen compounds (dissolved — ‘DON’ — and particulate — ‘PON’ — or incorporated in plant and other materials),

and for P, phosphates ( $\text{H}_3\text{PO}_4$ ,  $\text{PO}_4^{3-}$ ) as orthophosphate, as well as dissolved and particulate organic phosphate (DOP and POP).

In this publication, Mayer et al., Ohte et al., Widory, and Deegan et al. [7–10] described approaches to investigating  $\text{NO}_3^-$  flow or critical aspects of the nitrogen cycle, using nitrogen and oxygen stable isotopes ( $\delta^{15}\text{N}$ ,  $\delta^{18}\text{O}$ ) of  $\text{NO}_3^-$ . Mayer et al. explained the general principles used to investigate sources and transformations of  $\text{NO}_3^-$  or N-compounds and showed selected case studies based on natural abundance variations of the isotopic composition of  $\text{NO}_3^-$ . Mayer et al. also presented the limitations of N-isotope application in nutrient management and made recommendations to maximize the advantages of isotope applications. Ohte et al. focused on the simultaneous measurement of  $\delta^{15}\text{N}$  and  $\delta^{18}\text{O}$  of  $\text{NO}_3^-$  and showed that this approach facilitates the examination of spatial and temporal variations of isotopic compositions of nitrate in water systems. Widory further demonstrated the application of boron isotopes, a co-migrating tracer of  $\text{NO}_3^-$ , together with  $\delta^{15}\text{N}$  and  $\delta^{18}\text{O}$  of  $\text{NO}_3^-$ , to trace the origin of  $\text{NO}_3^-$ . A review of recent research and a case study suggested that the use of three isotopes ( $\delta^{11}\text{B}$ ,  $\delta^{15}\text{N}$ ,  $\delta^{18}\text{O}$ ) minimizes complications due to biological N transformation, often found in the application of dual isotopes of  $\text{NO}_3^-$ . Deegan et al. conducted the experimental addition of  $^{15}\text{NO}_3^-$  or  $^{15}\text{NH}_4^+$  into small streams as tracers and examined N uptake and transformation in streams using this so-called  $^{15}\text{N}$  labelling technique.

For phosphorus (P), McLaughlin et al. [11] evaluated the oxygen isotopic composition ( $\delta^{18}\text{O}_p$ ) of dissolved inorganic phosphate as an innovative tracer in the examination of P sources and cycling in rivers. The  $\delta^{18}\text{O}_p$  tracer has proved to be useful as a tracer for phosphate sources and cycling in various aquatic environments. Specifically, work to date indicates that  $\delta^{18}\text{O}_p$  is useful for determining sources of phosphate to aquatic systems (wastewater, fertilizer, and tributaries) if these sources have unique isotopic signatures and phosphate cycling within the examined system is limited compared to input fluxes. In addition, because various processes imprint specific fractionation effects, the  $\delta^{18}\text{O}_p$  tracer can be utilized to determine the degree of phosphorous cycling and processing through the biomass.

To differentiate between organic compounds of terrestrial (or transported) versus aquatic (or in-stream) origin, or examine various sources and pathways of nutrients in organic forms, stable carbon isotope  $\delta^{13}\text{C}$  [12] or the combination of  $\delta^{13}\text{C}$  and  $\delta^{15}\text{N}$  were analysed in the evaluation of the effects of land cover/land use change [13, 14] and those of river restoration measures [15]. As an explanation for readers who may be new to this approach, Hadwen and Bunn [13] presented an overview of studies on natural and human influences of nutrients in the aquatic food web in rivers, using the natural abundance of carbon ( $\delta^{13}\text{C}$ ) and nitrogen ( $\delta^{15}\text{N}$ ) isotope ratios and the experimental addition of  $^{15}\text{N}$  as tracers. Ballester et al. [12] analysed  $\delta^{13}\text{C}$  values of organic matter in tropical rivers and used geographic information system (GIS) tools to demonstrate how isotopes can reflect land cover changes. Rogers [14] used  $\delta^{13}\text{C}$  and  $\delta^{15}\text{N}$  values, concurrently with C/N ratios and heavy metals, to investigate short and long term influences of urbanization, industrialization and agricultural practices, among others, as potential sources of nutrients and contamination of aquatic ecosystems and the environment. Hein et al. [15] used  $\delta^{13}\text{C}$ ,  $\delta^{15}\text{N}$  and C/N ratio in the examination of sources and characteristics of organic matter in rivers in relation to hydrological conditions and restoration measures. Within a multiple isotope approach, other isotopes (such as  $\delta^{13}\text{C}/^{14}\text{C}$ ,  $\delta^{34}\text{S}$ ,  $^{87}\text{Sr}/^{86}\text{Sr}$ , Pb (e.g.  $^{206}\text{Pb}/^{204}\text{Pb}$ ,  $^{207}\text{Pb}/^{204}\text{Pb}$ ,  $^{208}\text{Pb}/^{204}\text{Pb}$ ,  $^{208}\text{Pb}/^{206}\text{Pb}$ ,  $^{207}\text{Pb}/^{206}\text{Pb}$ ),  $\delta^{66}\text{Zn}$ , etc.) have been also used, though less commonly (e.g. Refs [16–20]). These isotopes may assist in distinguishing between various nutrient sources or between nutrient sources and other components, such as precipitation, vari-

ous types of fertilizers and compost, and as age related tracers in sediments to establish historical environmental change.

### **3. WHAT CONSIDERATIONS ARE NEEDED FOR THE APPLICATION OF ISOTOPES?**

Stable isotopes are generally used to assess isotopic variations of natural abundances of compounds of interest or are artificially added to the ecosystem to trace water or nutrient pathways. Radioactive isotope ratios are determined by measuring decay activity and are useful for investigating issues related to residence time of, for example, water or carbon containing compounds. Isotopes are analysed in the gaseous form using an instrument (isotope ratio mass spectrometer, IRMS) which precisely measures isotope ratios of the compound of interest. The sample is usually transported from a sample preparation instrument (such as an elemental analyser) via continuous gas carrier flow (usually helium) to a mass spectrometer, where isotope ratio measurement occurs. Laboratory standards and international reference materials (with predetermined isotope values) are needed for ensuring utmost accuracy of isotope analyses. Although some isotope analyses may be more expensive than other chemical and hydrometric analyses due to the cost of instrumentation, there are often significant benefits in using isotope analyses as an environmental tool. Often the use of isotopes does not require as many monitoring sampling sites nor as high a sampling frequency as with other chemical and hydrometric measurements. Widory [9] aids in managerial evaluation by presenting costs and benefits of an isotope approach with some financial figures from a case study in France. More recently, laser isotope analysers are increasingly and more widely used for the analysis of stable water isotopes ( $\delta^2\text{H}$  and  $\delta^{18}\text{O}$ ) and carbon isotopes ( $\delta^{13}\text{C}$ ) (e.g. [21]). The use of laser isotope analysers has reduced the cost of instruments, installation of equipment, and the time required for analysis. Hence, the analytical costs for some isotope ratio determinations have been reduced, but laser techniques to analyse the isotopic composition of various nutrient compounds such as nitrate, ammonium and phosphate, are not yet available. Collaboration and cooperation among different institutions, as well as better planning and undertaking of the application of isotope techniques could substantially reduce project costs.

As described in this publication, isotope techniques are effective when the following conditions are met: (a) potential sources of nutrients can be identified and their isotope compositions analysed; (b) potential sources of nutrients have distinctly different isotope compositions (end-members) with limited isotopic variability (the ranges of end-member isotope ratios as well as those of materials to be analysed are presented in many chapters); and (c) the results of isotope data interpretation are complemented or supported by other approaches, such as findings from other chemical analysis, and hydrologic measurements and modelling, among others. For example, various environmental tracers and measurements, including isotope techniques, which detect and quantify the interaction between groundwater and surface water are summarized by Stellato and Newman [22].

In settings where the above mentioned prerequisites are met, isotopes are powerful tools to assess nutrient issues in river systems. However, the application of isotope techniques requires initial and continuous commitment in assuring technical, financial and human resources: the installation, calibration, operation and maintenance of instruments, and the establishment and practicing of quality control/quality assurance (QC/QA) of such procedures, among others. It is highly recommended to first consult specialists to evaluate the issues to be dealt with

and the comparative advantage of applying isotope techniques. Important questions include whether isotope techniques can help answer the questions water resource managers would like to tackle, which isotopes can be analysed from which media (water as carrier of nutrients, solutes, elements from living and non-living materials), in which laboratory the isotopes could be analysed, who could analyse samples and interpret the data, how long the duration of the study would be, and so on. Options also include possible collaboration and cooperation in fieldwork, the treatment and preparation of samples, isotope analysis in the laboratory, data analysis and interpretation, database establishment and updating and the repository of related information, and the sharing and exchange of data and related information.

#### **4. THE FUTURE OF ISOTOPE APPLICATIONS IN NUTRIENT STUDIES AND MANAGEMENT OF RIVER SYSTEMS**

Throughout the past few decades, several isotope techniques have been applied to examine sources, transformation and pathways of nutrients in riverine systems. Special focus has been placed on  $\text{NO}_3^-$ , N-compounds (given the prevalence of  $\text{NO}_3^-$  as a major source of nutrient pollution globally) and other organic matter in surface water and groundwaters, coupled with other approaches such as chemical analysis and hydrologic measurements. However, their application has often been limited to meeting scientific research needs and interests either due to lack of public knowledge of the usefulness of these isotope techniques, difficulties related to finding suitable laboratories, or cost. Recent developments to improve various analytical techniques for isotope determinations, simpler and more affordable instrumentation for some isotopes, and in many cases lower analytical costs associated with isotope analysis will promote the more widespread practical application of isotope techniques in the management of nutrient issues in the future.

In the coming years, isotopes are expected to be more extensively used to effectively identify sources of nutrients and characterize the transformation processes and flowpaths of nutrients in aquatic systems. Less commonly used isotopes may develop a greater role in the future as major or supplementary tracers in multiple isotope approaches, as seen in some papers in this publication.

Recent developments in geospatial techniques suggest that such approaches can play a complementary role in dealing with nutrient issues as well. For example, information on land cover/land use determined from satellite data and other sources, as discussed by Ballester et al. [12], could facilitate the identification of nutrient sources or trace various nutrient-containing compounds in urban, agricultural and industrial effluents in the receiving aquatic systems.

Further, as nutrients and nutrient-containing compounds may undergo a variety of transformation processes and take multiple possible pathways as a result of changes in pH,  $\text{O}_2$  saturation, temperature, redox and other conditions, analytical and numerical modelling could aid in the interpretation of isotope and other related data and measurements in complex modelled systems and vice versa. The movement, transformation, and assimilation of nutrients are part of a large ecosystem framework and in relation to C, N and P cycles are closely connected to biological activity in riverine systems. The examination of temporal and spatial changes in ecosystem processes due to climate or land use/land cover changes is also considered to be increasingly important. It is thus desirable to integrate isotope techniques that could help reveal



sources, transformation, pathways and fate of nutrients into efforts related to hydrological, hydrogeological and ecological modelling.

## REFERENCES

- [1] GRUNDY, R.D., Strategies for control of man-made eutrophication, *Environ. Sci. Technol.* **5** 12 (1971) 1184–1190.
- [2] GALLOWAY, J.N, et al., The nitrogen cascade, *Bioscience* **53** 4 (2003) 341–356.
- [3] HOWARTH, R.W., et al., Regional nitrogen budgets and riverine N and P fluxes for the drainages to the North Atlantic Ocean: natural and human influences, *Biogeochemistry* **35** (1996) 75–139.
- [4] VAN BREEMAN, N., et al., Where did all the nitrogen go? Fate of nitrogen inputs to large watersheds in the Northeastern USA, *Biogeochemistry* **57** (2002) 267–293.
- [5] STELLATO, L. NEWMAN, B.D., “The noble gas radon ( $^{222}\text{Rn}$ ) as a hydrogeological tracer of groundwater inputs to rivers and hyporheic exchange”, *Application of Isotope Techniques for Assessing Nutrient Dynamics in River Basins*, IAEA-TECDOC-1695, IAEA, Vienna (2013) 219–232.
- [6] KENDALL, C., MCDONNELL, J.J., (Eds), *Isotope Tracers in Catchment Hydrology*, Elsevier Science B.V., Amsterdam (1998).
- [7] MAYER, B., et al., “Isotopic assessment of nitrogen cycling in river basins: potential and limitations for nutrient management purposes”, *Application of Isotope Techniques for Assessing Nutrient Dynamics in River Basins*, IAEA-TECDOC-1695, IAEA, Vienna (2013) 15–34.
- [8] OHTE, N., et al., *ibid.*, 49–68.
- [9] WIDORY, D., *ibid.*, 35–48.
- [10] DEEGAN, L.A., et al., *ibid.*, 69–92.
- [11] MCLAUGHLIN, K., *ibid.*, 93–110.
- [12] BALLESTER, M.V.R., et al., *ibid.*, 173–186.
- [13] HADWEN, W., BUNN, S.E., *ibid.*, 111–128.
- [14] ROGERS, K.M., *ibid.*, 129–156.
- [15] HEIN, T., et al., *ibid.*, 157–172.
- [16] WANG, Y., et al., “Carbon cycling in terrestrial environments”, *Isotope Tracers in Catchment Hydrology* (KENDALL, C., MCDONNELL, J.J., Eds), Elsevier Science B.V., Amsterdam (1998) Ch. 17.
- [17] BULLEN, T.D., KENDALL, C., “Tracing of weathering reactions and water flowpaths: a multi-isotope approach”, *Isotope Tracers in Catchment Hydrology* (KENDALL, C., MCDONNELL, J.J., Eds), Elsevier Science B.V., Amsterdam (1998) Ch. 18.

- [18] KRAEMER, T.F., GENEREUX, D.P., “Applications of uranium- and thorium-series radionuclides in catchment hydrology studies”, *Isotope Tracers in Catchment Hydrology* (KENDALL, C., MCDONNELL, J.J., Eds), Elsevier Science B.V., Amsterdam (1998) Ch. 20.
- [19] KLAMINDER, J., et al., Flux rates of atmospheric lead pollution within soils of a small catchment in northern Sweden and their implications for future stream water quality, *Environ. Sci. Technol.* **40** (2006) 4639–4645.
- [20] STEDING, D.J., DUNLAP, C.E., FLEGAL, A.R., New Isotope evidence for chronic lead contamination in the San Francisco Bay estuary system: implications for the persistence of past industrial lead emissions in the biosphere, *PNAS* **97** 21 (2000) 11181–11186,
- [21] PENNA, D., et al., On the reproducibility and repeatability of laser absorption spectroscopy measurements for  $\delta^2\text{H}$  and  $\delta^{18}\text{O}$  isotopic analysis, *Hydrol. Earth Syst. Sci.* **14** (2010) 1551–1566.
- [22] STELLATO, L., NEWMAN, B.D., “Groundwater inputs to rivers: hydrological, biogeochemical and ecological effects inferred by environmental isotopes’, *Application of Isotope Techniques for Assessing Nutrient Dynamics in River Basins*, IAEA-TEDOC-1695, IAEA, Vienna (2013) 219–232.





# ISOTOPIC ASSESSMENT OF NITROGEN CYCLING IN RIVER BASINS: POTENTIAL AND LIMITATIONS FOR NUTRIENT MANAGEMENT PURPOSES

B. MAYER

Department of Geoscience,  
University of Calgary,  
Calgary, Alberta, Canada

M. SEBILO

The PMC University Paris 06  
UMR BIOEMCO,  
Paris, France

L.I. WASSENAAR <sup>1</sup>

Environment Canada,  
Saskatoon, Canada

## Abstract

It has been proposed that the stable isotopic composition of riverine nitrate may help reveal the predominant sources of N loading of riverine systems, including inorganic fertilizers and manure derived nitrates from agricultural systems and nitrates from urban wastewater effluents. A literature review reveals that rivers in pristine and forested headwaters are generally characterized by low nitrate concentrations and  $\delta^{15}\text{N}_{\text{nitrate}}$  values  $<5\%$ , whereas rivers draining well developed watersheds characterized by major urban centres and/or intensive agriculture have higher nitrate concentrations and  $\delta^{15}\text{N}_{\text{nitrate}}$  values of between  $+5$  and  $+15\%$ . Relating elevated  $\delta^{15}\text{N}_{\text{nitrate}}$  values to specific nitrogen sources or to estimate nutrient loading rates for management purposes, however, is challenging for a variety of reasons: (1) the nitrogen isotopic composition of agricultural derived nitrate can be variable and may overlap with the  $\delta^{15}\text{N}$  value of wastewater nitrate; (2) soil zone and riparian denitrification may cause changes in the concentration and isotopic composition of riverine nitrate; and (3) in-stream nutrient uptake processes may affect the isotopic composition of dissolved nitrogen compounds. To maximize the information gained from isotopic studies of riverine nitrogen compounds we recommend that: (1) numerous sampling sites are established along a river and sampled frequently in order to capture spatial and seasonal changes; (2) the isotopic composition of nitrate (including  $^{18}\text{O}/^{16}\text{O}$ ) and dissolved ammonium be determined if possible; (3) riverine nitrogen loading be determined and interpreted in context along with isotope data, and; (4) major and relevant nitrogen inputs to the watershed be identified and their isotopic values measured. This approach will help to minimize ambiguities in the interpretation of obtained isotope data and maximize the information required for nutrient management purposes.

## 1. INTRODUCTION

Human activity and widespread industrialized agricultural fertilization have greatly impacted the nitrogen (N) cycle of terrestrial and aquatic ecosystems (1997). As a consequence, the nitrogen loading of many landscapes and rivers around the globe has been increasing throughout the past decades [1–7]. The results of excess N entering receiving waters include water quality degradation, eutrophication, and in some cases hypoxia of coastal oceans and inland lakes.

---

<sup>1</sup> Present address: International Atomic Energy Agency, Isotope Hydrology Section, Vienna, Austria

Identifying the sources of nitrate and understanding its biogeochemical cycling in riverine systems is often challenging. Isotope techniques constitute a promising tool for determining the sources of nitrate in surface water and groundwater bodies, and aid in assessing the processes nitrate has undergone in aquatic systems. The objective of this section is to review recent research conducted based on natural abundance variations of the isotopic composition of nitrate in surface water systems. First, analytical developments will be reviewed that enable studies of the isotopic composition of nitrate and other nitrogen containing compounds. Second, the principles used for identifying sources and transformations of nitrate in the hydrosphere will be introduced, followed by selected case studies that demonstrate the potential and limitations of identifying sources and the biogeochemical history of nitrate in riverine systems using natural abundance isotope variations. Finally, some recommendations are made to minimize ambiguities in interpretation of the obtained isotope data and hence maximize insights obtained and required for management purposes. Other sections in this handbook focus on the isotopic composition of nitrate in groundwater (see Widory) and on the use of isotopically labelled compounds in studying nitrogen cycling in the hydrosphere (see Ballester).

## 2. DEVELOPMENT OF MEASUREMENT TECHNIQUES

The first nitrate–nitrogen isotope ratio measurements on water samples were reported in the 1950s by [8–9], but it was not until the early 1970s that determinations of  $\delta^{15}\text{N}$  values of dissolved ammonium and nitrate in surface water and groundwater samples gained more widespread use in hydrological studies (see, for example, Refs [10–13]. Nitrogen has two stable isotopes,  $^{14}\text{N}$  and  $^{15}\text{N}$ , with approximate natural abundances of 99.6337 and 0.3663%, respectively [14, 15]. Nitrogen isotope measurements are expressed using the delta scale:

$$\delta^{15}\text{N} [\text{‰}] = \left[ \frac{{}^{15}\text{N} / {}^{14}\text{N}_{\text{sample}}}{{}^{15}\text{N} / {}^{14}\text{N}_{\text{reference}}} - 1 \right] 1000$$

The primary reference for nitrogen isotope abundance measurements is atmospheric  $\text{N}_2$  [16]. Reference materials such as IAEA–N–1 (+0.43‰) and IAEA–N–2 (+20.32‰) with widely differing  $\delta^{15}\text{N}$  values [17] are available from the International Atomic Energy Agency (IAEA) for calibration and normalization purposes. Since the 1980s, a variety of different analytical methods have also been developed to determine the oxygen isotope ratio of  $\text{NO}_3^-$  (see Refs [18–23]). The combined measurement and interpretation of nitrogen and oxygen isotope ratios has facilitated the ability to trace the sources of dissolved nitrate and to more conclusively identify processes that nitrate may have undergone in many hydrological settings. Oxygen isotope ratios are reported in delta units in per mille (‰) relative to Vienna Standard Mean Ocean Water (V–SMOW). A number of reference materials with widely different  $\delta^{18}\text{O}_{\text{nitrate}}$  values have recently become available [24]. Their use has already started to improve the worldwide comparability of reported oxygen isotope ratios of nitrate.

In order to avoid inter-conversions of potentially labile nitrogen compounds such as ammonium ( $\text{NH}_4^+$ ), nitrate ( $\text{NO}_3^-$ ), dissolved (DON) or particulate organic nitrogen (PON), water samples must be 0.45  $\mu\text{m}$  filtered in the field and stored frozen, or in cold, dark containers. Samples should be processed as soon as possible upon return to the laboratory or stored frozen until further analysis.

Determining the nitrogen isotope ratios of  $\text{NH}_4^+$  and  $\text{NO}_3^-$  is historically achieved using three steps: (1) extraction of  $\text{NH}_4^+$  or  $\text{NO}_3^-$  from a water sample; (2) conversion of the extracted  $\text{NH}_4^+$ -N or  $\text{NO}_3^-$ -N into di-nitrogen gas ( $\text{N}_2$ ), and; (3) determination of the nitrogen isotope ratio of the produced  $\text{N}_2$  using an isotope ratio mass spectrometer (IRMS). Nowadays, the latter two steps are usually performed using thermal decomposition of a synthesized solid nitrogen compound in an elemental analyser (EA) and subsequent sweeping of the produced  $\text{N}_2$  with an He carrier gas into an isotope ratio mass spectrometer (IRMS) in continuous flow (CF) mode [25]. Prior to CF-IRMS techniques,  $\text{N}_2$  gas was produced off-line using hypobromite oxidation [26] or through combustion in quartz ampules [27] and measured via dual inlet isotope ratio mass spectrometry.

A number of different techniques have been suggested for the extraction of  $\text{NH}_4^+$  and  $\text{NO}_3^-$  from aqueous samples. Historically, nitrogen isotope ratios of ammonium ( $\text{NH}_4^+$ ) and nitrate ( $\text{NO}_3^-$ ) have been determined using variations of the Kjeldahl technique, which was initially developed for soil science applications [28]. In a large Kjeldahl distillation apparatus that accommodates samples of up to 1000 mL,  $\text{NH}_4^+$  in a water sample is converted to  $\text{NH}_3$  gas by raising the pH of the solution to  $\sim 9.5$  via addition of NaOH or MgO (see Ref. [29]). The liberated  $\text{NH}_3$  gas is distilled, trapped in an acidic solution, and converted to  $(\text{NH}_4)_2\text{SO}_4$ . Subsequent to the complete removal of  $\text{NH}_4^+$  from the original water sample,  $\text{NO}_3^-$  can be reduced to  $\text{NH}_4^+$  via addition of Devarda's alloy [28] and treated as described above to yield a second  $(\text{NH}_4)_2\text{SO}_4$  precipitate that is representative for  $\text{NO}_3^-$ -N. An alternative to the distillation method is the diffusion of released  $\text{NH}_3$  gas onto glass fibre filters acidified with sulphuric acid mounted in the headspace of closed containers [30] or floating enclosed in gas-permeable but hydrophobic PTFE (polytetrafluoro ethylene) membranes on the water sample [31–35]. Zeolites [36] and cation exchange resin beads [37] have also been used to recover  $\text{NH}_4^+$  from aqueous solutions. Nitrogen contained on precipitates, filters, resin beads or zeolites is subsequently converted to  $\text{N}_2$  typically by combustion in an elemental analyser, and the  $^{15}\text{N}/^{14}\text{N}$  ratio is determined by isotope ratio mass spectrometry. All Kjeldahl distillation or diffusion techniques have the disadvantage that nitrate–oxygen is removed during the reduction of nitrate to ammonium, making oxygen isotope measurements impossible.

Analytical techniques capable of determining the oxygen isotope ratio of dissolved nitrate initially relied on the synthesis of nitrate containing solids and their conversion to  $\text{CO}_2$  or  $\text{CO}$ . These gases are subsequently analysed for their  $^{18}\text{O}/^{16}\text{O}$  ratios either by off-line combustion in sealed quartz tubes followed by dual inlet IRMS, or using on-line pyrolysis–CF–IRMS techniques [38]. Amberger & Schmidt (1987) [39] generated  $\text{KNO}_3$  using  $\text{Hg}(\text{CN})_2$  as a combustion reagent. Revesz et al. (1997) [23] proposed a technique in which  $\text{KNO}_3$  was reacted with catalyzed graphite to generate  $\text{CO}_2$ ,  $\text{K}_2\text{CO}_3$  and  $\text{N}_2$ . Since there is oxygen isotope fractionation between  $\text{CO}_2$  and  $\text{K}_2\text{CO}_3$ , corrections are necessary to obtain the true  $\delta^{18}\text{O}$  value of nitrate. Silva et al. (2000) [20] described an analytical procedure in which nitrate is retained on ion exchange resins, subsequently eluted, and quantitatively converted to pure  $\text{AgNO}_3$ . Despite relatively high costs (ion exchange resins, silver oxide, etc.), this technique gained widespread acceptance for analysis of the isotopic composition of nitrate from freshwaters. However, analysis of water samples with high contents of dissolved organic carbon (DOC) or high contents of total dissolved solids remained challenging. These problems were recently overcome by the so-called denitrifier technique. In this procedure, dissolved nitrate is quantitatively reduced to  $\text{N}_2\text{O}$  by denitrifying bacteria that lack  $\text{N}_2\text{O}$ -reductase activity. The generated  $\text{N}_2\text{O}$  gas is subsequently used for nitrogen [40] and oxygen [21] isotope analyses. A detailed discussion of this analytical approach is provided in Ref. [41]. An alternate means of determining the iso-

topic composition of nitrate is based on a chemical conversion using spongy Cd and sodium azide [22].

### 3. GENERAL PRINCIPLES AND PAST STUDIES

#### 3.1. Identification of sources of nitrate

Numerous attempts have been made to use nitrogen isotope ratios to determine the sources of nitrate in surface water and groundwater. These were particularly successful in situations where nitrate came from only one source with a unique  $\delta^{15}\text{N}$  value (for example, from sewage or manure, see Fig. 1 and Ref. [42]), but assessing the respective contributions from two or more sources remained challenging. Kohl et al. (1971) [11] were among the first to utilize nitrogen isotope ratio variations to determine sources of nitrate in surface waters. In an agricultural watershed in Illinois, USA, they observed a trend of decreasing  $\delta^{15}\text{N}$  values (from +10 to +4‰) with increasing nitrate concentrations. Based on a simple two end-member mixing model ( $\delta^{15}\text{N}_{\text{soil N}} = +13\text{‰}$ ;  $\delta^{15}\text{N}_{\text{fertilizer}} = +3\text{‰}$ ) they concluded that at times of peak nitrate concentration, more than 50% of the nitrate-N in surface water originated from synthetic fertilizers. This approach was criticized [10, 43] partially because there are often variable isotope fractionation effects during nitrogen transformations in the biosphere and pedosphere that need to be considered in source apportionments based solely on nitrogen isotope ratios. Feigin et al. (1974) [44] demonstrated that isotope fractionation during nitrification of anhydrous ammonia fertilizer can exceed 10‰ depending on pool size and nitrification rates. Even larger nitrogen isotope fractionation effects have been described for volatilization of  $\text{NH}_3$ , leaving the remain-

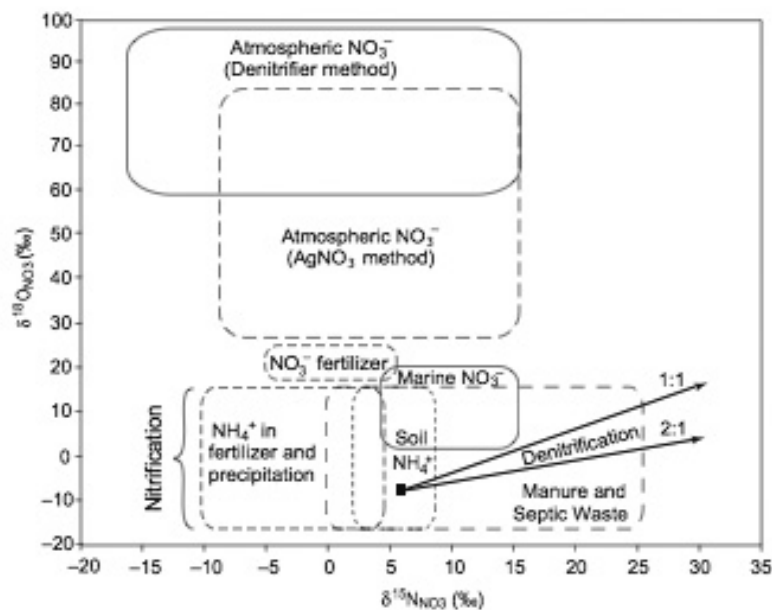

FIG. 1. Typical ranges for  $\delta^{15}\text{N}$  and  $\delta^{18}\text{O}$  values of nitrate from: (1) atmospheric deposition, (2) synthetic nitrate containing fertilizers, (3) nitrification processes in soils, and (4) sewage and manure. The arrow indicates the trend of  $\delta^{15}\text{N}$  and  $\delta^{18}\text{O}$  values of the remaining nitrate during denitrification, assuming initial nitrate with  $\delta^{15}\text{N} \sim 6\text{‰}$  and  $\delta^{18}\text{O} \sim -5\text{‰}$  (from Ref. [46]).

ing  $\text{NH}_4^+$  enriched in  $^{15}\text{N}$  [45], making a quantitative assessment of contributions from various nitrate sources based on nitrogen isotope ratios alone problematic in many situations.

The dual isotope approach based on the determination of  $\delta^{15}\text{N}$  and  $\delta^{18}\text{O}$  values of nitrate has improved our ability to identify sources of nitrate in aquatic systems (Fig. 1). Nitrate derived from manure or sewage is usually characterized by  $\delta^{15}\text{N}$  values of between +7 and more than +20‰ [12, 47–52]. It is therefore often distinct from nitrate in atmospheric deposition (typically between –11 and +8‰), nitrate in synthetic fertilizers (near 0‰), and nitrate generated via nitrification processes in soils [46, 53]. Usually, the latter three sources cannot be differentiated by nitrogen isotope analyses alone because of their overlapping ranges of  $\delta^{15}\text{N}$  values (Fig. 1). However, recent research has shown that nitrate from atmospheric deposition has positive  $\delta^{18}\text{O}$  values ranging from +30 to +94‰ [46, 53–55]. Nitrate-containing synthetic fertilizers have  $\delta^{18}\text{O}_{\text{nitrate}}$  values near  $+22 \pm 3\%$  [18, 51, 55]. Nitrate derived from nitrification processes in soils typically has  $\delta^{18}\text{O}$  values of less than +15‰ [54, 56, 57] and nitrate in manure and sewage has similarly low  $\delta^{18}\text{O}$  values [47, 51]. Hence, the combined determination of  $\delta^{15}\text{N}$  and  $\delta^{18}\text{O}$  values of dissolved nitrate provides a tool for distinguishing between four major nitrate sources: (1) atmospheric nitrate deposition, (2) nitrate containing synthetic fertilizers, (3) nitrate derived from nitrification, for example in soils, and (4) nitrate in manure and sewage (see Fig. 1).

### 3.2. Identification of processes

Isotope tracing of nitrogen containing compounds in unsaturated or partially saturated soil and in the vadose zone is not straightforward, since numerous transformation processes in the nitrogen cycle are associated with significant but variable isotope effects. During volatilization, the conversion of  $\text{NH}_4^+$  to  $\text{NH}_3$ ,  $^{14}\text{N}$  is preferentially converted to  $\text{NH}_3$ , leaving the remaining  $\text{NH}_4^+$  enriched in  $^{15}\text{N}$  [45, 58]. Nitrification, the conversion of  $\text{NH}_4^+$  to  $\text{NO}_3^-$ , can also proceed with significant nitrogen isotope fractionation, preferentially accumulating  $^{14}\text{N}$  in the produced  $\text{NO}_3^-$ , provided that the substrate is not limited [59]. During the nitrification process, three new oxygen atoms are introduced into the newly formed nitrate molecule. Typically, two of these oxygens are derived from ambient water and one from  $\text{O}_2$  [56], resulting in  $\delta^{18}\text{O}_{\text{nitrate}}$  values of between  $< -5\%$  to +15‰, depending on environmental conditions [54, 57].

Another process causing significant alterations in the isotopic composition of nitrate in aquatic systems is microbial denitrification, during which the lighter isotopes  $^{14}\text{N}$  and  $^{16}\text{O}$  are preferentially metabolized by microorganisms causing an enrichment of the heavy isotopes  $^{15}\text{N}$  and  $^{18}\text{O}$  in the remaining nitrate as concentrations decrease [59, 60]. The increase in  $\delta^{15}\text{N}_{\text{nitrate}}$  values due to microbial denitrification appears to be up to two times that of  $\delta^{18}\text{O}_{\text{nitrate}}$  [61]. Hence, the remaining nitrate eventually assumes elevated  $\delta^{15}\text{N}$  and  $\delta^{18}\text{O}$  values, which are unique for nitrate that has undergone denitrification under closed system conditions (Fig. 1).

Interestingly, nitrate in surface water or groundwater rarely has the same isotopic composition as nitrate in atmospheric deposition or in synthetic fertilizers. The typically low  $\delta^{18}\text{O}$  values ( $< 15\%$ ) of aqueous nitrate provide strong evidence that nitrate from atmospheric deposition ( $\delta^{18}\text{O}_{\text{nitrate}}$  typically  $> +50\%$ ) and nitrate from synthetic fertilizers ( $\delta^{18}\text{O}_{\text{nitrate}} \sim +23\%$ ) does not behave conservatively in the water unsaturated zone, but rather undergoes immobilization–mineralization cycles in the soils [62]. The three original oxygen atoms of the nitrate molecule are removed during the immobilization process and hence nitrate from atmospheric deposition or from synthetic fertilizers loses its original oxygen isotope signature. Three new oxygens are



### a) denitrification

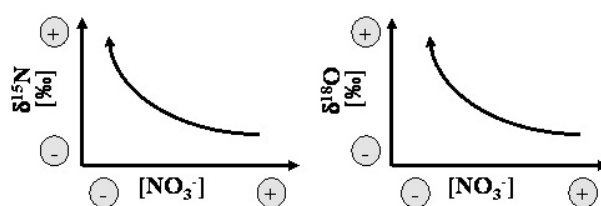

### b) admixture of nitrate from manure or sewage

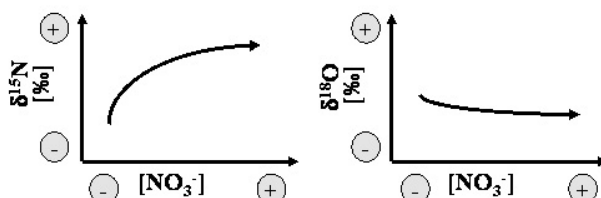

FIG. 2. Trends of concentration and isotopic composition of nitrate during (a) denitrification; (b) admixture of nitrate from manure or sewage; from Ref. [63].

acquired during the subsequent mineralization process and the  $\delta^{18}\text{O}$  value of the newly formed nitrate (typically  $<15\text{‰}$ ) is indicative of nitrate from soil nitrification. Mengis et al. (1999) [62] demonstrated in lysimeter experiments that conservative tracing of fertilizer nitrate with the dual isotope approach ( $\delta^{15}\text{N}$  and  $\delta^{18}\text{O}$ ) is only possible under conditions of very low microbial activity (such as in winter), but fails under the biologically active conditions present during the growing season because of the rapid immobilization–mineralization turnover of nitrogen in soils. It is also important to note that pure nitrate containing fertilizers (like  $\text{KNO}_3$ ) with  $\delta^{18}\text{O}$  values near  $+23\text{‰}$  are rarely used in agriculture, while ammonium nitrate, ammonium sulfate, anhydrous ammonia and urea containing fertilizers are preferred. All these products will, after conversion to nitrate, yield low  $\delta^{18}\text{O}_{\text{nitrate}}$  values (Fig. 1).

In some situations, a plot of  $\delta^{15}\text{N}_{\text{nitrate}}$  and  $\delta^{18}\text{O}_{\text{nitrate}}$  values may conclusively reveal the mixing of nitrate from two sources (Fig. 1). However, simultaneous monitoring of spatial or temporal trends in concentration and  $\delta^{15}\text{N}$  and  $\delta^{18}\text{O}$  values of nitrate has proven to be a more effective approach for revealing the impact of a single nitrogen source, mixing of nitrate from various sources, and the occurrence of transformation processes in aquatic systems. Decreasing nitrate concentrations with increasing  $\delta^{15}\text{N}_{\text{nitrate}}$  [60, 64] and  $\delta^{18}\text{O}_{\text{nitrate}}$  values [60] are indicative of denitrification (Fig. 2a). Using a combination of hydrological, chemical, and isotopic techniques, denitrification has been identified in groundwater systems [48, 61], riparian zones [62, 65], and surface waters [66].

Trends of increasing nitrate concentrations accompanied by increasing  $\delta^{15}\text{N}_{\text{nitrate}}$  values are often typical for admixture of nitrate from an anthropogenic source (Fig. 2b). Nitrate derived from sewage [47] or manure [67, 68] has been identified in surface waters and groundwaters using a combination of chemical and isotopic techniques.

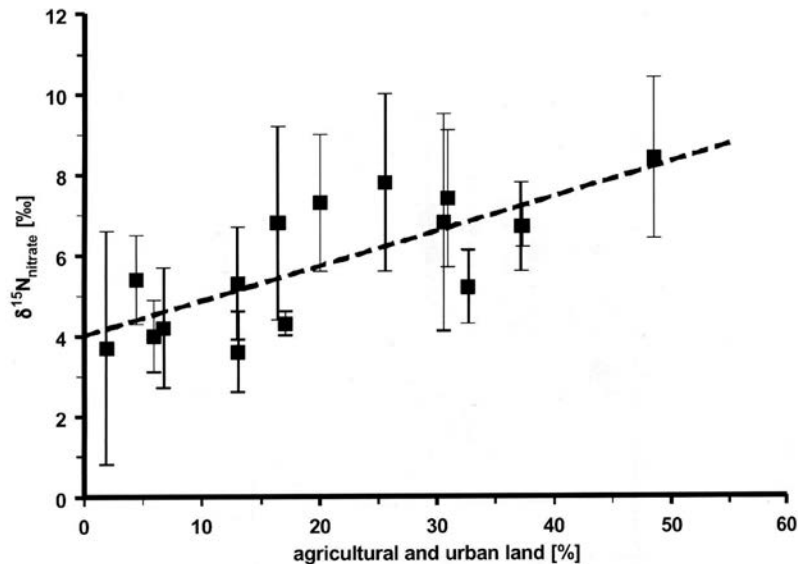

FIG. 3. Mean  $\delta^{15}\text{N}$  values of riverine nitrate for 16 rivers' draining watersheds in the northeastern USA versus land use (from Ref. [69]). There is a trend to increasing  $\delta^{15}\text{N}$  values with increasing proportions of urban and agricultural land.

#### 4. RECENT CASE STUDIES

The above described principles guiding natural abundance isotope variations in the nitrogen cycle have been applied with considerable success to assess sources and transformations of nitrate in surface waters.

##### 4.1. Isotopic composition of riverine nitrogen compounds

Recent research has repeatedly revealed a correlation between  $\delta^{15}\text{N}$  values of riverine nitrate and land use (Fig. 3). In forested headwater regions, nitrate concentrations in rivers and creeks are usually low and  $\delta^{15}\text{N}$  values of nitrate are often below 5‰. Concurrent low  $\delta^{18}\text{O}$  values indicate that nitrate is predominantly derived from nitrification in forest soils [57], and only on rare occasions are significant contributions from 'un-recycled' atmospheric nitrate detected (see Ref. [41]). With increasing downstream distance and additional influences from urban centers and/or agricultural return flows, riverine nitrate concentrations often increase accompanied by increasing  $\delta^{15}\text{N}$  values (Fig. 3), while  $\delta^{18}\text{O}$  values of nitrate remain low. To explain these trends it is important to gain a thorough understanding of the isotopic composition of potential nitrate sources affecting riverine nitrogen loads.

##### 4.2. Nitrogen inputs and their isotopic signals

Synthetic fertilizers such as ammonium sulfate, ammonium nitrate, anhydrous ammonia and urea containing products have usually  $\delta^{15}\text{N}$  values between  $-4$  and  $+4$ ‰ with an average  $\delta^{15}\text{N}$  value near 1‰ [53, 70–73]. Hence, at first glance it appears that nitrate derived from fertilizers cannot be responsible for the trend of increasing  $\delta^{15}\text{N}$  values in riverine nitrate in watersheds with significant proportions of agricultural land use. After application, however, nitrogen from synthetic fertilizers is often incorporated into soil organic matter, or is influenced by volatiliza-



tion and denitrification in agricultural soils. Both of these processes enrich the remaining  $\text{NH}_4^+$  and  $\text{NO}_3^-$  in  $^{15}\text{N}$ . Consequently, nitrate in soils and agricultural return flows is often characterized by  $\delta^{15}\text{N}$  values of between +4 and +8‰, even if synthetic fertilizers with  $\delta^{15}\text{N}$  values near 0‰ are the predominant nitrogen input [74].

Manure from cattle, chickens, and hogs is an alternate fertilizer widely used in agriculture, particularly near intensive feedlots. Depending upon manure type and manure treatment,  $\delta^{15}\text{N}$  values of total N range between less than 10‰ for manure to more than 20‰ for nitrate leachates from manure piles [51, 67, 68, 75, 76]. The storage of animal waste is often accompanied by N volatilization. Therefore, manure derived nitrate in agricultural return flows often has  $\delta^{15}\text{N}$  values in the range of 10 to 15‰ [68] and hence is a potential candidate for increasing riverine  $\delta^{15}\text{N}$  values in regions with agricultural land use (Fig. 3).

Effluents from municipal wastewater treatment plants are another source of riverine nitrate, particularly since nitrogen compounds in the effluent are usually piped directly into rivers. The distribution and  $\delta^{15}\text{N}$  values of the released nitrogen compounds depend on the type and efficiency of the available treatment technology. Inefficient treatment of raw sewage will result in effluents that contain significant quantities of ammonium. For example, the average  $\text{NH}_4^+$  concentration in effluent from the Achères treatment plant near Paris (France) was found to be 16.7 mg/L with an average  $\delta^{15}\text{N}$  value of 9.3‰ [77]. In contrast, more efficient secondary treatment featuring repeated nitrification denitrification cycles will result in wastewater effluents that contain nitrogen predominantly in the form of nitrate. For instance, the effluent from the Bonny Brook wastewater treatment plant in Calgary (Alberta, Canada) contains typically less than 20 mg/L nitrate with a  $\delta^{15}\text{N}$  values near +10‰ while average  $\text{NH}_4^+$  concentrations vary between 1.4 and 3.2 mg/L [78]. Highly efficient tertiary treatment results in significantly decreased nitrate concentrations in the effluents with  $\delta^{15}\text{N}$  values that may exceed 30‰ as a result of effective denitrification in these plants (Voss, personal communication). Therefore, the release of nitrogen compounds with elevated  $\delta^{15}\text{N}$  values from wastewater treatment plants is another potential reason for increasing  $\delta^{15}\text{N}$  values of riverine nitrate in watersheds with significant proportions of urban land use (Fig. 3).

### 4.3. In-stream processes

Once nitrogen compounds have entered riverine systems, they may undergo further in-stream transformation processes, such as assimilation of  $\text{NH}_4^+$  or  $\text{NO}_3^-$ , nitrification of  $\text{NH}_4^+$ , and benthic denitrification. These processes have the potential to alter the isotope compositions of riverine nitrogen compounds on diurnal and seasonal time scales, thereby further complicating source apportionment attempts for riverine nitrogen compounds based on isotope techniques.

Significant amounts of  $\text{NH}_4^+$  may enter riverine systems with some wastewater effluents. With increasing downstream distance, this  $\text{NH}_4^+$  may be oxidized to  $\text{NO}_3^-$ , a process that is associated with significant nitrogen isotope fractionation favouring the light isotope  $^{14}\text{N}$  in the produced nitrate, while  $^{15}\text{N}$  progressively accumulates in the remaining  $\text{NH}_4^+$  [44, 59, 79]. Sebilo et al. (2006) [77] demonstrated that due to nitrification of  $\text{NH}_4^+$  released from the Achères treatment plant,  $\delta^{15}\text{N}$  values of the remaining  $\text{NH}_4^+$  in the Seine River downstream of Paris increased up to +30‰ as  $\text{NH}_4^+$  concentrations decreased. As a consequence of the addition of newly formed nitrate with low nitrogen isotope ratios,  $\delta^{15}\text{N}$  values of riverine nitrate may decrease by several ‰, dependent on the pre-existing (upstream) nitrate load and its isotopic composition. It is,

however, important to note that after complete nitrification, the newly produced  $\text{NO}_3^-$  will have a  $\delta^{15}\text{N}$  value similar to that of the initial  $\text{NH}_4^+$ .

Uptake and assimilation of  $\text{NH}_4^+$  and  $\text{NO}_3^-$  also have the capability of affecting fluxes and isotopic compositions of riverine nitrogen compounds. Johannsen et al. (2008) [80] observed an increase in  $\delta^{15}\text{N}$  values of riverine nitrate of between +0.5 and +2.5‰ for several German rivers in the summer months, while nitrate concentrations decreased. This was attributed to phytoplankton activity displaying a slight preference for  $^{14}\text{N}$  and  $^{16}\text{O}$  during uptake and assimilation of nitrogen compounds [81, 82], leaving the remaining nitrate enriched in  $^{15}\text{N}$  and  $^{18}\text{O}$ . Correlations between chlorophyll *a* contents in the stream water and variations in  $\delta^{15}\text{N}$  and  $\delta^{18}\text{O}$  values provided further evidence of the significant impact of nitrogen uptake and assimilation on the isotopic composition of riverine nitrate [80].

The impact of nutrient additions to rivers can lead to biological nitrogen assimilation through increases in aquatic primary productivity that, if unchecked, can result in eutrophication or harmful changes in an aquatic food web structure. We are not aware of any studies that have linked riverine nitrate isotopic data to dynamic (diel or seasonal) aquatic productivity processes, although these should be possible through linkages with assays of aquatic productivity determined by using dissolved  $\text{O}_2$  isotopes [83, 84].

Denitrification is another process that is usually accompanied by significant nitrogen and oxygen isotope fractionation. For nitrogen isotope ratios, isotopic enrichment factors varying from 0 to -30‰ have been reported in literature. Denitrification is a multi-step microbial process that requires the presence of an electron donor such as organic carbon and which occurs in redox zones with dissolved oxygen contents of less than 2 mg/L [85]. The extent of nitrogen isotope fractionation appears to be dependent upon whether or not denitrification is diffusion limited [86]. In rivers and lakes with oxygenated water columns, the rate limiting step for denitrification is usually the diffusion of nitrate into the sediments, where denitrification rapidly proceeds to completion under appropriate redox conditions. Under these circumstances, typical for benthic denitrification, the extent of nitrogen isotope fractionation is usually small, ranging from 0 to -5‰ with an average enrichment factor of -4‰ [86, 87]. Therefore, diffusion limited denitrification occurring in river or lake sediments may cause a decrease in nitrate concentrations, but will have a negligible effect on the isotopic composition of riverine nitrate. In contrast, denitrification in aquifers, riparian and hyporheic zones is typically not rate limited by diffusion. As a consequence, nitrogen enrichment factors reported in literature are significantly higher, ranging from -10 to -30‰ with a mean value of circa -18‰ [86]. The extent of oxygen isotope fractionation is usually half of that reported for nitrogen [61], but deviations to this 2:1 trend for  $\delta^{15}\text{N}$  and  $\delta^{18}\text{O}$  changes have been recently reported [46] as indicated by the 1:1 trend for denitrification in Fig. 3. Elevated  $\delta^{15}\text{N}$  and  $\delta^{18}\text{O}$  values in remaining nitrate have been reported for aquifers [48, 61], riparian zones [62, 65, 88], and hyporheic systems [89]. Partially denitrified  $^{15}\text{N}$  and  $^{18}\text{O}$  enriched nitrate from these systems entering rivers has the potential to significantly alter the isotopic composition of riverine nitrate [66].

#### **4.4. Riparian zones**

Much has been written regarding denitrification and plant uptake of nitrate during transport from soil, surface runoff and groundwater flow paths through riparian zones, including the use of engineered buffer strips to reduce nitrogen fluxes from agricultural soils and shallow groundwater into streams. Stable isotope studies of nitrogen uptake and denitrification in ripar-

ian zones are fewer, starting in the late 1990s [86, 90–99]. Findings regarding nitrate in riparian zones are usually site specific, with little attention paid to seasonality. Riparian retention of nitrate may occur through plant uptake with little isotope fractionation of residual nitrate, or in the case of sufficient organic matter and anoxic conditions in sediments by full or partial denitrification resulting in significant isotope fractionation and isotopic enrichment of residual nitrate. Several studies noted that riparian plant  $^{15}\text{N}/^{14}\text{N}$  ratios may be a good proxy indicator of near surface riparian denitrification. Depending on the hydrological, redox, and biological conditions of the riparian zone, nitrate may pass unmodified through the riparian zone to enter streams and rivers with an isotopic composition similar to that of groundwater or with elevated  $^{15}\text{N}$  and  $^{18}\text{O}$  contents. Given the fact that most riparian zones contain elevated organic matter (especially those in agricultural settings) it is more likely that nitrate leaching into streams and rivers under riparian conditions will have somewhat higher  $\delta^{15}\text{N}$  and  $\delta^{18}\text{O}$  values compared to the original or upstream nitrate.

#### **4.5. Limitation of source apportionment approaches**

Thorough knowledge of the type of nitrogen compounds and their isotopic compositions released from various land use areas in a study region (Sec. 4.2) is an essential pre-requisite for elucidating the sources of riverine nitrate using isotope techniques. In addition, the isotopic composition of riverine nitrate can be further modified by nitrogen transformation processes, particularly during the biologically active summer months (Sec. 4.3). Another caveat is that the isotopic composition of nitrate released from wastewater treatment plants and nitrate derived from agricultural return flows may be rather similar. This can make it challenging to obtain detailed quantitative information about the sources of riverine nitrate, particularly if a sampling programme is sporadic and restricted to a small number of sites.

### **5. RECOMMENDATIONS FOR FUTURE STUDIES**

Several of the above mentioned limitations can be addressed by conducting comprehensive sampling and analytical programmes, and by interpreting the obtained isotope data for ammonium and nitrate in concert with hydrometric and chemical parameters.

#### **5.1. Sampling sites and sampling frequency**

Some earlier studies obtained nitrate from one sampling site, often at the mouth of a river, to identify the major sources of riverine nitrate (see Ref. [69]). In order to investigate how different sources of nitrate impact river systems along their flowpath, it is highly desirable to establish numerous sampling sites along a river and frequently obtain samples (for example, monthly). This approach allows for separate assessment of the impacts of distinct land use units on riverine nitrate.

As an example, Fig. 4 displays the mean  $\delta^{15}\text{N}$  values for riverine nitrate in the South Saskatchewan River basin and its tributaries in western Canada [100]. All tributaries are sourced in the Rocky Mountains to the west and are characterized by  $\delta^{15}\text{N}$  values of nitrate of less than +5‰, indicating that the nitrate is predominantly derived from nitrification in forest soils. At the Red Deer River,  $\delta^{15}\text{N}$  values of riverine nitrate remain essentially unchanged with downstream distance, since this tributary is not affected by major urban centers or agricultural activities. In contrast,  $\delta^{15}\text{N}$  values of riverine nitrate in the Bow River increase below the City of

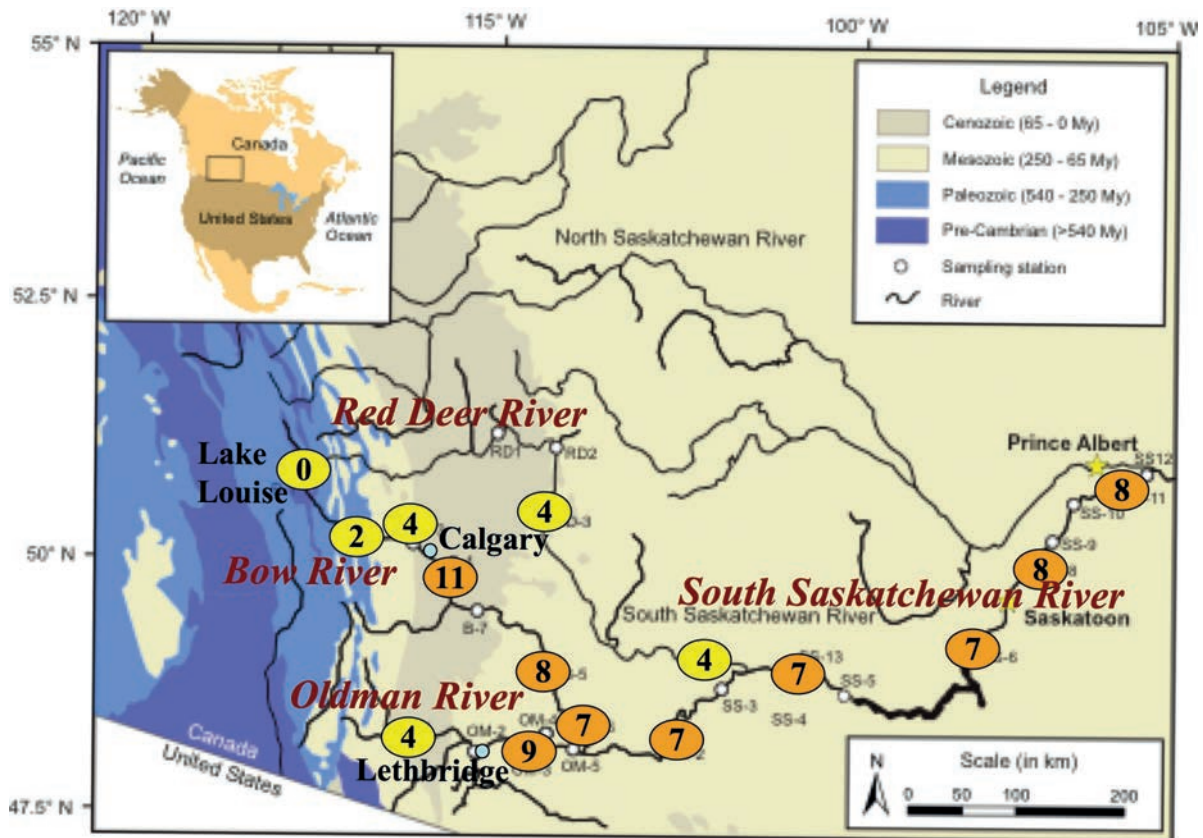

FIG. 4. Mean  $\delta^{15}\text{N}$  values of riverine nitrate in ‰ for 15 sampling sites along the South Saskatchewan River and its tributaries; samples taken in 2003 and 2004 (from Ref. [100]). Three major tributaries, the Red Deer River, the Bow River, and the Oldman River, are all sourced in the Rocky Mountains to the west, and flow eastwards to form the South Saskatchewan River.

Calgary to +11‰. Due to the choice of sampling sites, it is evident that increasing  $\delta^{15}\text{N}$  values resulted from the impact of municipal wastewater effluents. In the Oldman River basin,  $\delta^{15}\text{N}$  values of riverine nitrate also increased with increasing flow distance. This tributary basin is sparsely populated, but is characterized by intensive, partially irrigated, agriculture and a high number of large feedlot operations. A detailed sampling and analysis programme revealed that elevated  $\delta^{15}\text{N}$  values in the downstream portions of the Oldman River were caused by manure derived nitrate in agricultural return flows [68]. After the confluence of the three tributaries to form the South Saskatchewan River, average  $\delta^{15}\text{N}$  values of nitrate remain consistently near +7‰. It is obvious that it would be challenging to evaluate whether this is caused by urban and/or agricultural nitrogen inputs if no up-stream sampling had been conducted.

## 5.2. Analytical parameters

Identifying the sources and biogeochemical transformations of riverine nitrate based on stable isotope techniques is primarily based on the measurement of its  $^{15}\text{N}/^{14}\text{N}$  and  $^{18}\text{O}/^{16}\text{O}$  ratios (see Sec. 2). An analysis of  $\delta^{17}\text{O}$  values of nitrate provides an additional tracer for identifying atmospheric nitrate contributions due to the characteristic, mass-independent isotope signal associated with this nitrate source [46, 101–103]. Where abundant, such as downstream of wastewater treatment plants, it is also important to determine the  $^{15}\text{N}/^{14}\text{N}$  ratios of ammoni-



um. These isotope data, however, should not be interpreted in isolation. The measurement of a number of additional physical and chemical parameters is often helpful, if not essential, in assisting interpretations regarding sources of riverine nitrogen compounds and of the processes they may have undergone. Obtaining water quantity data from nearby hydrometric stations is important to assess potential dilution effects. The measurement of field parameters including temperature, pH, and most importantly dissolved oxygen contents may provide essential information for interpreting variations in the isotope ratios of nitrogen compounds. In addition, determination of major and minor ion chemistry of the water samples may provide additional clues regarding potential pollution sources. In some cases, complimentary analyses of the isotopic composition of water ( $\delta^2\text{H}$  &  $\delta^{18}\text{O}$ ) and other dissolved constituents such as sulfate ( $\delta^{34}\text{S}$ ), boron ( $\delta^{11}\text{B}$ ) or dissolved inorganic carbon ( $\delta^{13}\text{C}_{\text{DIC}}$ ) may also provide insights regarding water and pollution sources. Interpreting the obtained isotope data in concert with hydrometric and chemical parameters is often essential for arriving at conclusive interpretations regarding the sources and the fate of nitrogen compounds in riverine systems.

### **5.3. Determination of riverine N loads**

If hydrometric and chemistry data are available for a number of sampling stations along a river system, it is highly recommended to determine nitrate and ammonium fluxes (or loads) for respective sampling sites. The obtained nitrogen loads, calculated by relating water flows to nitrate and ammonium concentrations, will reveal at which river segments nitrate and ammonia fluxes increase markedly, decrease, or remain essentially constant [104]. Such information can support interpretations based on isotopic information regarding nitrate or ammonia additions or removal due to N transformation processes between subsequent sampling stations along a riverine system.

### **5.4. Assessment of anthropogenic N inputs to the watershed**

Another useful approach is to estimate anthropogenic nitrogen inputs to the catchment of interest [4, 105, 106]. This method relies partially on census data and estimates nitrogen input via atmospheric deposition, synthetic fertilizers, animal waste, and wastewater effluents, among others. While not all of these sources will influence riverine nitrate due to a multitude of retention and conversion processes in the watershed, this method nevertheless reveals which anthropogenic nitrogen inputs are dominant and which are insignificant in a watershed. This knowledge may be useful in supporting conclusions regarding the major sources of riverine nitrate based on stable isotope data.

### **5.5. Determination of the isotopic composition of potential N sources**

And finally, it is essential to determine the isotopic composition of potential sources of riverine nitrate and their variabilities. For agricultural areas, it is important to measure the isotopic composition of nitrate in the return flows rather than simply relying on isotopic characterization of nitrogen inputs such as synthetic fertilizers or manure. Furthermore, the treatment efficiency of wastewater treatment plants may vary with time. As a consequence, the released nitrogen compounds and their isotopic ratios may display some variability that should be assessed wherever possible.

## 6. CONCLUSIONS

Analyses of the  $\delta^{15}\text{N}$  and  $\delta^{18}\text{O}$  values of nitrate can provide unique information about sources and processes that affect the fluxes of nitrate in riverine systems. Careful planning and conducting of elaborate sampling and analysis programmes in combination with a thorough characterization of all potential nitrate sources in a watershed and interpretation of obtained isotope data in concert with hydrometric and chemical parameters has the potential to yield more quantitative results in the future. However, isotope effects during nitrogen transformation processes and isotopic variabilities in the isotopic composition of various nitrate sources limit the degree to which a quantitative assessment of nitrate sources to riverine nitrate is possible.

In the past, much of the stable isotope research on nitrate in rivers has focussed on source apportionment and biogeochemical transformations of nitrate. Future isotopic studies are needed to better capture the temporal transformations that occur on a daily (diel productivity) and on a seasonal basis in riverine systems. Also, future nitrogen isotope studies in riverine systems should focus on the impacts of N cascading on riverine primary productivity and aquatic food webs.

## REFERENCES

- [1] GALLOWAY, J.N., et al., The nitrogen cascade, *BioScience* **53** 4 (2003) 341–356.
- [2] GOOLSBY, D.A., Mississippi basin nitrogen flux believed to cause gulf hypoxia *EOS* **81** 29 (2000) 321–327.
- [3] GRUBER, N., GALLOWAY, J.N., An Earth-system perspective of the global nitrogen cycle, *Nature* **451** 7176 (2008) 293–296.
- [4] HOWARTH, R.W., et al., Regional nitrogen budgets and riverine N & P fluxes for the drainages to the North Atlantic Ocean: natural and human influences, *Biogeochem.* **35** (1996) 75–139.
- [5] JAWORSKI, N.A., HETLING, L.J., Water quality trends of Mid-Atlantic and northeast watersheds over the past 100 years, *Watershed's 96*, Water Environment Federation, Baltimore, MD (1996) 980–983.
- [6] TURNER, R.E., RABALAIS, N.N., Changes in Mississippi River water quality this century. *BioSci.* **41** (1991) 140–147.
- [7] VAN BREEMEN, N., et al., Where did all the nitrogen go? Fate of nitrogen inputs to large watersheds in the Northeastern USA, *Biogeochem* **57** (2002) 267–293.
- [8] HOERING, T., Variations of nitrogen-15 in abundance in naturally occurring substances, *Science* **122** (1955) 1233–1234.
- [9] HOERING, T., The isotopic composition of the ammonia and the nitrate ion in rain, *Geochim. Cosmochim. Acta* **12** (1957) 97–102.
- [10] EDWARDS, A.P., Isotopic tracer techniques for identification of sources of nitrate pollution, *J. Environ. Qual.* **2** (1973) 382.

- [11] KOHL, D.H., SHEARER, G.B., COMMONER, B., Fertilizer nitrogen: contribution to nitrate in surface water in a corn belt watershed, *Science* **174** (1971) 1331–1334.
- [12] KREITLER, C.W., Nitrogen-isotope ratio studies of soils and groundwater nitrate from alluvial fan aquifers in Texas, *J. Hydrol.* **42** (1979) 147–170.
- [13] KREITLER, C.W., JONES, D.C., Natural soil nitrate: the cause of the nitrate contamination of ground water in Runnels County, Texas, *Ground Water* **13** (1975) 53–61.
- [14] JUNK, G., SVEC, H.J., The absolute abundance of the nitrogen isotopes in the atmosphere and compressed gas from various sources, *Geochim. Cosmochim. Acta* **14** (1958) 234–243.
- [15] ROSMAN, K.J.R., TAYLOR, P.D.P., Isotopic composition of the elements 1997, *Pure Appl. Chem.* **70** (1998) 217–235.
- [16] MARIOTTI, A., Atmospheric nitrogen is a reliable standard for natural  $^{15}\text{N}$  abundance measurements, *Nature* **303** (1983) 685.
- [17] COPLEN, T.B., et al., Compilation of minimum and maximum isotope ratios of selected elements in naturally occurring terrestrial materials and reagents, 01–4222, USGS Water-Resources Investigations Report 01–4222, Reston, Virginia (2002).
- [18] AMBERGER, A., Natürliche  $^{15}\text{N}$  und  $^{18}\text{O}$  Gehalte als Indikatoren für die Herkunft von Nitrat in Boden und Grundwasser. Ph.D. Thesis, Technical University Munich, Munich (1987).
- [19] BRÄUER, K., STRAUCH, G., An alternative procedure for the  $^{18}\text{O}$  measurement of nitrate oxygen, *Chem. Geol.* **168** (2000) 283–290.
- [20] SILVA, S.R., et al., A new method for collection of nitrate from fresh water and the analysis of nitrogen and oxygen isotope ratios, *J. Hydrol.* **228** (2000) 22–36.
- [21] CASCIOTTI, K.L., SIGMAN, D.M., HASTINGS, M., BOEHLKE, J.K., HILKERT, A., Measurement of the oxygen isotopic composition of nitrate in seawater and fresh-water using the denitrifier method, *Anal. Chem.* **74** (2002) 4905–4912.
- [22] McILVIN, M.R., ALTABET, M.A., Chemical conversion of nitrate and nitrite to nitrous oxide for nitrogen and oxygen isotopic analysis in freshwater and seawater, *Anal. Chem.* **77** 17 (2005) 5589–5595.
- [23] REVESZ, K., BÖHLKE, J.K., YOSHINARI, T., Determination of  $\delta^{18}\text{O}$  and  $\delta^{15}\text{N}$  in nitrate, *Anal. Chem.* **69** (1997) 4375–4380.
- [24] BÖHLKE, J.K., MROCKOWSKI, S.J., COPLEN, T.B., Oxygen isotopes in nitrate: new reference materials for  $^{18}\text{O}:^{17}\text{O}:^{16}\text{O}$  measurements and observations on nitrate-water equilibration, *Rapid Commun. Mass Spectrom.* **17** (2003) 1835–1846.
- [25] BARRIE, A., PROSSER, S.J., “Automated analysis of light element stable isotopes by isotope ratio mass spectrometry”, *Mass Spectrometry of Soils* (BOUTTON, T.W., YAMASAKI, S.I., Eds), Marcel Dekker, New York (1996) 1–46.
- [26] BREMNER, J.M., “Total nitrogen”, *Methods of Soil Analysis*, American Society of Agronomy, Madison (1965) 1149–1178.

- [27] KENDALL, C., GRIM, E., Combustion tube method for measurement of nitrogen isotope ratios using calcium oxide for total removal of carbon dioxide and water, *Anal. Chem.* **62** (1990) 526–529.
- [28] BREMNER, J.M., KEENEY, D.R., Steam distillation methods for determination of ammonium, nitrate and nitrite, *Anal. Chim. Acta* **32** (1965) 485–495.
- [29] CLINE, J.D., KAPLAN, I.R., Isotopic fractionation of dissolved nitrate during denitrification in the Eastern Tropical North Pacific Ocean, *Mar. Chem.* **3** 4 (1975) 271–299.
- [30] BROOKS, P.D., STARK, J.M., MCINTEER, B.B., PRESTON, P., Diffusion method to prepare soil extracts for automated nitrogen-15 analysis, *Soil Sci. Soc. Am. J.* **53** (1989) 1707–1711.
- [31] HOLMES, R.M., MCCLELLAND, J.W., SIGMAN, D.M., FRY, B., PETERSON, B.J., Measuring  $^{15}\text{N-NH}_4^+$  in marine, estuarine and freshwater: an adaption of the ammonia diffusion methods for samples with low ammonium concentration, *Mar. Chem.* **60** (1998) 2235–2243.
- [32] SEBILO, M., MAYER, B, GRABLY, M, BILLIOU, D., MARIOTTI, A., The use of the ‘ammonium diffusion’ method for  $\delta^{15}\text{N-NH}_4^+$  and  $\delta^{15}\text{N-NO}_3^-$  measurements: Comparison with other techniques, *Environ. Chem.* **1** (2004) 99–103.
- [33] SIGMAN, D.M., et al., Natural abundance level measurement of the nitrogen isotopic composition of oceanic nitrate: an adaption of the ammonium diffusion method, *Mar. Chem.* **57** (1997) 227–242.
- [34] SORENSON, P., JENSEN, E.S., Sequential diffusion of ammonium and nitrate from soil extracts to a polytetrafluorethylene trap for  $^{15}\text{N}$  determination, *Anal. Chim. Acta* **252** (1991) 201–203.
- [35] STARK, J.M., HART, S.C., Diffusion technique for preparing salt solutions, Kjeldahl digests, and persulfate digests for nitrogen-15 analysis, *Soil Sci. Soc. Am. J.* **60** (1996) 1846–1855.
- [36] VELINSKY, D.J., PENNOCK, J.R., SHARP, J.H., CIFUENTES, L.A., FOGEL, M.L., Determination of the isotopic composition of ammonium-nitrogen at the natural abundance level from estuarine waters, *Mar. Chem.* **26** (1989) 351–361.
- [37] LEHMANN, M.F., BERNASCONI, S.M., MCKENZIE, J.A., A simple method for the extraction of ammonium from freshwaters for nitrogen isotope analysis, *Anal. Chem.* **73** (2001) 4717–4721.
- [38] REVESZ, K., BÖHLKE, J.K., Comparison of  $\delta^{18}\text{O}$  measurements in nitrate by different combustion techniques, *Anal. Chem.* **74** (2002) 5410–5413.
- [39] AMBERGER, A., SCHMIDT, H.L., Natürliche Isotopengehalte von Nitrat als Indikatoren für dessen Herkunft. *Geochim. Cosmochim. Acta* **51** (1987) 2699–2705.
- [40] SIGMAN, D.M., et al., A bacterial method for the nitrogen isotopic analysis of nitrate in seawater and freshwater, *Anal. Chem.* **73** (2001) 4145–4153.



- [41] OHTE, N., et al., “Simultaneous measurement of nitrogen and oxygen isotopes of nitrate to evaluate nitrate sources and processes in catchments”, Application of Isotope Techniques for Assessing Nutrient Dynamics in River Basins, IAEA, Vienna (in preparation).
- [42] MARIOTTI, A., “Utilisation des variations naturelles d’abondance isotopique en  $^{15}\text{N}$  pour tracer l’origine des pollutions des aquifers par les nitrates”, *Isotope Hydrology* 1983, IAEA, Vienna, Austria (1984) 605–63.
- [43] HAUCK, R.D., et al., Use of variations in natural nitrogen isotope abundance for environmental studies: a questionable approach, *Science* **177** (1972) 453–454.
- [44] FEIGIN, A., SHEARER, G., KOHL, D.H., COMMONER, B., The amount and nitrogen-15 content of nitrate in soil profiles from two central Illinois fields in a corn-soybean rotation, *Soil Sci. Soc. Amer. Proc.* **38** (1974) 465–471.
- [45] WELLMAN, R.P., COOK, F.D., KROUSE, H.R., Nitrogen-15: Microbiological alteration of abundance, *Science* **161** (1968) 269–270.
- [46] KENDALL, C., ELLIOTT, E.M., WANKEL, S.D., “Tracing anthropogenic inputs of nitrogen to ecosystems”, *Stable Isotopes in Ecology and Environmental Science* (MICHENER, R.H., LAJTHA, K., Eds), Blackwell Publishing, Oxford (2007) 375–449.
- [47] ARAVENA, R., EVANS, M.L., CHERRY, J.A., Stable isotopes of oxygen and nitrogen in source identification of nitrate from septic systems, *Ground Water* **31** (1993) 180–186.
- [48] ARAVENA, R., ROBERTSON, W.D., Use of multiple isotope tracers to evaluate denitrification in ground water: study of nitrate from a large-flux septic system plume, *Ground Water* **36** (1998) 975–982.
- [49] GORMLY, J.R., SPALDING, R.F., Sources and concentrations of nitrate-nitrogen in ground water of the Central Platte Region, Nebraska, *Ground Water* **17** (1979) 291–301.
- [50] KREITLER, C.W., BROWNING, L.A., Nitrogen-isotope analysis of groundwater nitrate in carbonate aquifers: natural sources versus human pollution, *J. Hydrol.* **61** (1983) 285–301.
- [51] WASSENAAR, L.I., Evaluation of the origin and fate of nitrate in the Abbotsford Aquifer using the isotopes of  $^{15}\text{N}$  and  $^{18}\text{O}$  in  $\text{NO}_3^-$ , *Appl. Geochem.* **10** (1995) 391–405.
- [52] WASSENAAR, L.I., HENDRY, M.J., HARRINGTON, N., Decadal geochemical and isotopic trends for nitrate in a transboundary aquifer and implications for agricultural beneficial management practices, *Environ. Sci. Technol.* **40** (2006) 4626–4632.
- [53] KENDALL, C., “Tracing nitrogen sources and cycling in catchments”, *Isotope Tracers in Catchment Hydrology* (KENDALL, C., MCDONNELL, J.J., Eds), Elsevier, Amsterdam (1998) 521–576.
- [54] DURKA, W., SCHULZE, E.-D., GEBAUER, G., VOERKELIUS, S., Effects of forest decline on uptake and leaching of deposited nitrate determined from  $^{15}\text{N}$  and  $^{18}\text{O}$  measurements, *Nature* **372** (1994) 765–767.

- [55] VOERKELIUS, S., Isotopendiskriminierungen bei der Nitrifikation und Denitrifikation: Grundlagen und Anwendungen der Herkunfts-Zuordnung von Nitrat und Distickstoffmonoxid, TU Munich, Munich (1990) 119.
- [56] HOLLOCHER, T.C., Source of the oxygen atoms of nitrate in the oxidation of nitrite by *Nitrobacter agilis* and evidence against a P–O–N anhydride mechanism in oxidative phosphorylation, *Arch. Biochem. Biophys.* **233** (1984) 721–727.
- [57] MAYER, B., BOLLWERK, S.M., MANSFELDT, T., HÜTTER, B., VEIZER, J., The oxygen isotope composition of nitrate generated by nitrification in acid forest floors, *Geochim. Cosmochim. Acta* **65** 16 (2001) 2743–2756.
- [58] LETOLLE, R., “Nitrogen–15 in the natural environment”, *Handbook of Environmental Isotope Geochemistry: The Terrestrial Environment* (FRITZ, P., FONTES, J.C., Eds), Elsevier, Amsterdam (1980) 407–433.
- [59] MARIOTTI, A., et al., Experimental determination of nitrogen kinetic isotope fractionation: some principles; illustration for the denitrification and nitrification processes, *Plant and Soil* **62** (1981) 413–430.
- [60] MARIOTTI, A., GERMON, J.C., LECLERC, A., Nitrogen isotope fractionation associated with the  $\text{NO}_2 \rightarrow \text{N}_2\text{O}$  step of denitrification in soils, *Can. J. Soil Sci.* **62** (1982) 227–241.
- [61] BÖTTCHER, J., STREBEL, O., VOERKELIUS, S., SCHMIDT, H.-L., Using isotope fractionation of nitrate-nitrogen and nitrate-oxygen for evaluation of microbial denitrification in a sandy aquifer, *J. Hydrol.* **114** (1990) 413–424.
- [62] MENGIS, M., et al., Multiple geochemical and isotopic approaches for assessing ground water  $\text{NO}_3^-$  elimination in a riparian zone, *Ground Water* **37** (1999) 448–457.
- [63] MAYER, B., “Assessing sources and transformations of sulphate and nitrate in the hydrosphere using isotope techniques”, *Isotope in the Water Cycle: past, present and future of a developong science* (AGGARWAL, P.K., GAT, J.R., FROEHLICH, F.O., Eds), Springer (IAEA), Dordrecht (2005) 67–89.
- [64] MARIOTTI, A., LANDREAU, A., SIMON, B.,  $^{15}\text{N}$  isotope biogeochemistry and natural denitrification process in ground water: application to the chalk aquifer in northern France, *Geochim. Cosmochim. Acta* **52** (1988) 1869–1878.
- [65] CEY, E.E., RUDOLPH, D.L., ARAVENA, R., PARKIN, G., Role of the riparian zone in controlling the distribution and fate of agricultural nitrogen near a small stream in southern Ontario, *J. Contaminant Hydrol.* **37** (1999) 45–67.
- [66] KELLMAN, L., HILLAIRE-MARCEL, C., Nitrate cycling in streams: using natural abundances of  $\text{NO}_3^-$ – $\delta^{15}\text{N}$  to measure in-situ denitrification, *Biogeochem.* **43** (1998) 273–292.
- [67] KARR, J.D., SHOWERS, W.J., GILLIAM, J.W., ANDRES, A.S., Tracing nitrate transport and environmental impact for intensive swine farming using delta nitrogen–15, *J. Environ. Qual.* **30** (2001) 1163–1175.

- [68] ROCK, L., MAYER, B., Isotopic Assessment of Sources of Surface Water Nitrate within the Oldman River Basin, Southern Alberta, Canada, *Water Air Soil Poll.: Focus* **4** 2 (2004) 545–562.
- [69] MAYER, B., et al., Sources of nitrate in rivers draining sixteen watersheds in the north-eastern U.S.: Isotopic constraints, *Biogeochem.* **57/58** (2002) 171–197.
- [70] DEUTSCH, B., MEWES, M., LISKOW, I., VOSS, M., Quantification of diffuse nitrate inputs into a small river system using stable isotopes of oxygen and nitrogen in nitrate, *Org. Geochem.* **37** (2006) 1333–1342.
- [71] HERBERT, C.E., WASSENAAR, L.I., Stable nitrogen isotopes in waterfowl feathers reflect agricultural land use in western Canada, *Environ. Sci. and Technol.* **35** (2001) 3482–3487.
- [72] HÜBNER, H., “Isotope effects of nitrogen in the soil and biosphere”, *Handbook of Environmental Isotope Geochemistry: The Terrestrial Environment* (Fritz, P., Fontes, J.C., Eds), Elsevier, Amsterdam (1986) 361–425.
- [73] VITORIA, L., OTERO, N., SOLER, A., CANALS, A., Fertilizer characterization: isotopic data (N, S, O, C and Sr), *Environ. Sci. Technol.* **38** (2004) 3254–3262.
- [74] SEBILO, M., The PMC Univ Paris 06, UMR, BIEMCO, Paris, France, unpublished data.
- [75] WIDORY, D., “The benefit of using isotopes in the NO<sub>3</sub> water quality management”, this volume.
- [76] WIDORY, D., et al., Nitrates in groundwater: an isotopic multi-tracer approach, *J. Contam. Hydrol.* **72** (2004) 165–188.
- [77] SEBILO, M., et al., Assessing nitrification and denitrification in the Seine River and estuary using chemical and isotopic techniques, *Ecosystems* **9** (2006) 564–577.
- [78] IWANYSHYN, M., RYAN, M.C., CHU, A., Separation of physical loading from photosynthesis/respiration processes in rivers by mass balance, *Sci. Total Environ.* **390** (2008) 205–214.
- [79] CASCIOTTI, K.L., SIGMAN, D.M., WARD, B.B., Linking diversity and stable isotope fractionation in ammonia-oxidizing bacteria, *Geomicrobiol. J.* **20** (2003) 335–353.
- [80] JOHANNSEN, A., DAEHNKE, K., EMEIS, K., Isotopic composition of nitrate in five German rivers discharging into the North Sea, *Org. Geochem.* **39** 12 (2008) 1678–1689.
- [81] GRANGER, J., SIGMAN, D.M., NEEDOBA, J.A., HARRISON, J.A., Coupled nitrogen and oxygen isotope fractionation of nitrate during assimilation by cultures of marine phytoplankton, *Limnol. Oceanogr.* **49** 5 (2004) 1763–1773.
- [82] WANKEL, S.D., KENDALL, C., FRANCIS, C.A., PAYTAN, A., Nitrogen sources and cycling in the San Francisco Bay Estuary: A nitrate dual isotopic composition approach, *Limnol. Oceanogr.* **51** 4 (2006) 1654–1664.
- [83] VENKITESWARAN, J., SCHIFF, S., WASSENAAR, L.I., Aquatic metabolism and ecosystem health assessment using dissolved O<sub>2</sub> stable isotope diel curves, *Ecol. Appl.* **18** (2008) 965–982.

- [84] VENKITESWARAN, J., WASSENAAR, L.I., SCHIFF, S., Diel dynamics of dissolved oxygen isotopic ratios: primary production, respiration, and gas exchange in aquatic ecosystems, *Oecologia* **153** 2 (2007) 385–398.
- [85] KOROM, S.F., Natural denitrification in the saturated zone: a review, *Water Resour. Res.* **28** (1992) 1657–1668.
- [86] SEBILO, M., BILLEN, G., GRABLY, M., MARIOTTI, A., Isotopic composition of nitrate-nitrogen as a marker of riparian and benthic denitrification at the scale of the whole Seine River system, *Biogeochem.* **63** (2003) 35–51.
- [87] LEHMANN, M.F., REICHERT, P., BERNASCONI, S.M., Modeling nitrogen and oxygen isotope fractionation during denitrification in a lacustrine redox-transition zone. *Geochim. Cosmochim. Acta* **67** (2003) 2529–2542.
- [88] DEVITO, K.J., FITZGERALD, D., HILL, A.R., ARAVENA, R., Nitrate dynamics in relation to lithology and hydrologic flow path in a river riparian zone, *J. Environ. Quality* **29** 4 (2000) 1075–1084.
- [89] HINKLE, S.R., et al., Linking hyporheic flow and nitrogen cycling near the Willamette River - a large river in Oregon, USA, *J. Hydrol.* **244** (2001) 157–180.
- [90] CHEN, D.J.Z., MACQUARRIE, K.T.B., Numerical simulation of organic carbon, nitrate, and nitrogen isotope behavior during denitrification in riparian zones, *J. Hydrol.* **293** (2004) 235–254.
- [91] CLEMENT, J.C., HOLMES, R.M., PETERSON, B.J., PINAY, G., Isotopic investigation of denitrification in a riparian ecosystem in western France, *J. Appl. Ecology* **40** (2003) 1035–1048.
- [92] FUKADA, T., HISCOCK, K.M., DENNIS, P.F., GRISCHEK, T., A dual isotope approach to identify denitrification in groundwater at a river-bank infiltration site, *Water Research* **37** 13 (2003) 3070–3078.
- [93] FUKUHARA, H., NEMOTO, F., TAKEUCHI, Y., TODA, N., Nitrate dynamics in a reed belt of a shallow sand dune lake in Japan: Analysis of nitrate retention using stable nitrogen isotope ratios, *Hydrobiologia* **584** (2007) 49–58.
- [94] OSTROM, N.E., HEDIN, L.O., VON FISCHER, J.C., ROBERTSON, G.P., Nitrogen transformations and NO<sub>3</sub><sup>-</sup> removal at a soil-stream interface: a stable isotope approach, *Ecol. Appl.* **12** 4 (2002) 1027–1043.
- [95] PFEIFFER, S.M., BAHR, J.M., BEILFUSS, R.D., Identification of groundwater flow-paths and denitrification zones in a dynamic floodplain aquifer, *J. Hydrol.* **325** (2006) 262–272.
- [96] REINHARDT, M., MULLER, B., GACHTER, R., WEHRLI, B., Nitrogen removal in a small constructed wetland: an isotope mass balance approach, *Environ. Sci. Technol.* **40** 10 (2006) 3313–3319.
- [97] REVSBECH, N.P., JACOBSEN, J.P., NIELSEN, N.P., Nitrogen transformations in microenvironments of river beds and riparian zones, *Ecol. Engineering* **24** (2005) 447–455.

- [98] SIDLE, W.C., ROOSE, D.L., YZERMAN, V.T., Isotope evaluation of nitrate attenuation in resored and native riparian zones in the Kankakee watershed, Indiana, *Wetlands* **20** 2 (2000) 333–345.
- [99] TSUSHIMA, K., et al., Nitrate decrease with isotopic fractionation in riverside sediment column during infiltration experiment, *Water Air Soil Pollut.* **174** (2006) 47–61.
- [100] MAYER, B., WASSENAAR, L.I., ROCK, L., MCCALLUM, J.E., “Combining hydrological, chemical and isotopic approaches to identify sources and fate of sulfate and nitrate in the South Saskatchewan River system, Canada”, *Int. Symp. Advances in Isotope Hydrology and its role in Sustainable Water Resources Management*, IAEA, Vienna (2007) 493–500.
- [101] MICHALSKI, G., et al., Tracing atmospheric nitrate deposition in a complex semiarid ecosystem using  $\delta^{17}\text{O}$ , *Environ. Sci. Technol.* **38** 7 (2004) 2175–2181.
- [102] MICHALSKI, G., SAVARINO, J., BOEHLKE, J.K., THIEMENS, M., Determination of the total oxygen isotopic composition of nitrate and the calibration of a  $\delta^{17}\text{O}$  nitrate reference material, *Anal. Chem.* **74** (2002) 4989–4993.
- [103] MICHALSKI, G., SCOTT, Z., KABILING, M., THIEMENS, M.H., First measurements and modeling of  $\delta^{17}\text{O}$  in atmospheric nitrate, *Geophys. Res. Lett.* **30** 16 (2003).
- [104] ROCK, L., MAYER, B., Tracing nitrate and sulphate in river basins using isotope techniques, *Water Sci. Techn.* **53** 10 (2006) 209–217.
- [105] BOYER, E.W., GOODALE, C.L., JAWORSKI, N.A., HOWARTH, R.W., Anthropogenic nitrogen sources and relationships to riverine nitrogen export in the northeastern USA, *Biogeochemistry* **57** (2002) 137–169.
- [106] ROCK, L., MAYER, B., Nitrogen budget for the Oldman River Basin, southern Alberta, Canada, *Nutrient Cycling in Agroecosystems* **75** (2006) 147–162.

# THE BENEFIT OF USING ISOTOPES IN NO<sub>3</sub> WATER QUALITY MANAGEMENT

D. WIDORY  
BRGM, MMA/ISO,  
Orléans, France

## Abstract

Nitrate (NO<sub>3</sub>) is one of the world's major pollutants of drinking water resources. Although recent European directives have reduced input from intensive agriculture, NO<sub>3</sub> levels in groundwater are dangerously approaching the drinking water limit of 50 mg/L almost everywhere. Determining the sources of groundwater contamination is an important first step towards improving its quality through emission control. It is with this aim that we will review the benefit of using a multi-isotopic approach ( $\delta^{15}\text{N}$ ,  $\delta^{18}\text{O}$  and  $\delta^{11}\text{B}$ ), in addition to conventional hydrogeological analyses, to trace the origin of NO<sub>3</sub> pollution in water. Recent research widely shows the significant added value of using these three isotopes to precisely distinguish nitrate sources, trace them in water and (semi)-quantify their respective contributions. The isotope approach inherently provides more information than classical chemical studies (based mainly on the monitoring of NO<sub>3</sub> concentrations), and the technical/economical feasibility of integrating it as part of water body characterization and analysis of pressure and impact due to nitrate pollution, for the more effective implementation of environmental management measures in river basins can be demonstrated to policy makers.

## 1. INTRODUCTION

Nitrate (NO<sub>3</sub>) is one of the world's major pollutants of drinking water resources. The levels in ground and surface waters are often exceeding the drinking water limit of 50 mg/L. This pollution is a serious and well recognized problem for the sustainable management of groundwater and surface water in many European river basins. (See the EU report published in 2002 entitled "Implementation of Council Directive 91/676/EEC concerning the protection of waters against pollution caused by nitrates from agricultural sources, synthesis from year 2000 Member States reports").

Agricultural practices, such as the use of fertilizers, manure or sewage sludge for crop growth, have a clear impact on the quality of surface water bodies and groundwater with regard to nitrate concentrations. This has important consequences for the management of river basins (surface and groundwater) as well as on marine coastal environments, in regards to nutrient pollution, eutrophication, and nitrogen balances in grassland and arable land. Similarly, wastewater effluents released from water treatment plants impact nitrogen mass balances in the surrounding environment. As a result of nitrate pollution, there are territories (in French Brittany for example) in which local authorities periodically issue warnings to the general population to avoid using tap water for drinking and cooking purposes, and recommend using (or provide) costlier bottled mineral water.

Today, all parties concerned with nitrate pollution, including governments, cities, water companies, farmers, and the general public, agree that significant improvements in managing and controlling anthropogenic inputs of nitrate in the environment are urgently required in order to preserve water quality and environmental integrity. There is a high demand for appropriate and



reliable tools to improve management of nitrate pollution at local, national, European and international levels. Expectations with respect to this issue in terms of public opinion, and hence legislation, are extraordinarily important in many states.

Main nitrate sources include: mineral fertilizers, animal manure, domestic or industrial wastewater, leaking septic systems, atmospheric deposition, decomposition of soil organic matter or geologically retarded release of earlier discharged nitrate.

Several European directives (e.g. EC directive 91/976/EEC, 2000/60/EC, 2006/118/EC) have been initiated to reduce overall nitrate input from intensive agricultural activities. Unfortunately, several remedial actions have proven to be ineffective as they did not properly target nitrate pollution originating from agricultural or domestic sources. The development of effective management practices to preserve water quality or to implement proper remediation plans for polluted sites requires the identification of nitrate sources and an understanding of processes affecting these concentrations. The relationship between nitrate concentrations in ground and surface water and the quantity of nitrate introduced from a particular source is difficult to quantify due to the co-existence of several bio-geochemical processes and the variety of nitrate sources (sources can be single or multiple; point or diffused).

The analysis of nitrogen ( $\delta^{15}\text{N}$ ) and oxygen ( $\delta^{18}\text{O}$ ) stable isotopes in nitrate ( $\text{NO}_3^-$ ) provides direct source identification based on distinct and characteristic N and O isotopic compositions (fingerprint or signature) for nitrates originating from different pollution sources. However, these isotopic compositions may be altered through the biological cycling of nitrogen for which proper corrections are required. Recent available literature shows that stable isotopes of boron (B), a co-migrating tracer of nitrate, can be useful in providing additional information for nitrate source apportionment. However, additional information, such as chemical and hydro-geological data, is still required for the proper interpretation of isotopic compositions. Accurate knowledge of different source contributions to nitrate pollution enable the application of local source oriented remedies. This multi-isotope approach presents a greater advantage of enabling better management of nitrate inputs in ground and surface waters.

## 2. NITROGEN, OXYGEN AND BORON ISOTOPES IN WATER

When using the N isotopic signature as a tracer of a  $\text{NO}_3^-$  source, there might be interference between dilution of polluted groundwater and natural denitrification (both affecting the  $\delta^{15}\text{N}$  of dissolved nitrate). A simple binary mixing model can describe the pollution process (for example, dilution of the polluting end-member by a baseline end-member that represents the unpolluted groundwater). Each end-member is characterized by its N concentration ( $N$ ) and corresponding  $\delta^{15}\text{N}$ , as described by the following mixing equation system:

$$N_r \times f + N_p \times (1 - f) = N$$

$$N_r \times f \times \delta^{15}N_r + N_p \times (1 - f) \times \delta^{15}N_p = N \times \delta^{15}N$$

where r and p are the reference and pollution end-members, respectively, and  $f$  is the proportion (relative contribution) ( $0 \leq f \leq 1$ ) of the baseline end-member in the mix.



Pauwels et al. [1] showed that both autotrophic and heterotrophic denitrification can occur in the same catchment. If an aquifer rock contains pyrite ( $\text{FeS}_2$ ), the presence of  $\text{Fe}^{2+}$  and a general tendency towards the presence of  $\text{SO}_4^{2-}$  in conjunction with a decrease in  $\text{NO}_3^-$  may indicate an  $\text{NO}_3^-$  reduction coupled with pyrite oxidation in groundwater (autotrophic denitrification):



Heterotrophic denitrification (oxidation of organic matter catalyzed by heterotrophic bacteria) contributes to the production of  $\text{CO}_2$  without increasing  $\text{SO}_4$  as follows (note that  $\text{CH}_2\text{O}$  is a simplified formula for organic matter):

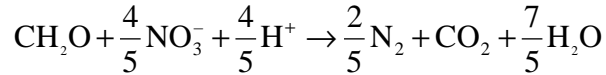

Both autotrophic and heterotrophic reactions are accompanied by an isotopic fractionation, inducing a  $^{15}\text{N}$  and  $^{18}\text{O}$  enrichment of residual  $\text{NO}_3^-$  that is described by the classic Rayleigh distillation law:

$$\delta - \delta_0 = \varepsilon \ln \frac{C}{C_0}$$

where  $\delta$  is the  $\delta^{15}\text{N}$ ,  $\delta^{18}\text{O}$  of the residual  $\text{NO}_3^-$ ,  $\delta_0$  the  $\delta^{15}\text{N}$ ,  $\delta^{18}\text{O}$  of the initial  $\text{NO}_3^-$  (before denitrification),  $C$  the  $\text{NO}_3^-$  concentration,  $C_0$  the initial  $\text{NO}_3^-$  concentration, and  $\varepsilon$  the isotopic enrichment factor. In a  $\delta^{15}\text{N}$ – $\delta^{18}\text{O}$  diagram the denitrification process is shown by a straight line with a slope of 2:1 (see, for example, Ref. [2]).

The isotopic composition of B, as a  $\text{NO}_3^-$  co-migrant, is not affected by denitrification and can therefore be used as a tracer of mixing processes. The pollution process is then described by a mixing equation system similar to the nitrogen systematic (N is replaced by B). Nevertheless, interaction with the aquifer matrix leads to dissolution of B-bearing silicates or adsorption–desorption processes with clays or ferrihydroxides which may affect the isotopic composition and concentration of dissolved B.

### 3. CHARACTERIZATION OF ANTHROPOGENIC INPUTS

N, O and B isotope composition ranges of the principal anthropogenic sources are summarized in Fig. 1.

#### 3.1. Manure

Nitrogen in excreted waste is present mainly as urea, which is hydrolyzed to  $\text{NH}_3$  and converted to  $\text{NH}_4$  and finally to  $\text{NO}_3^-$  in the soil:

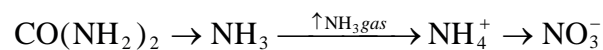

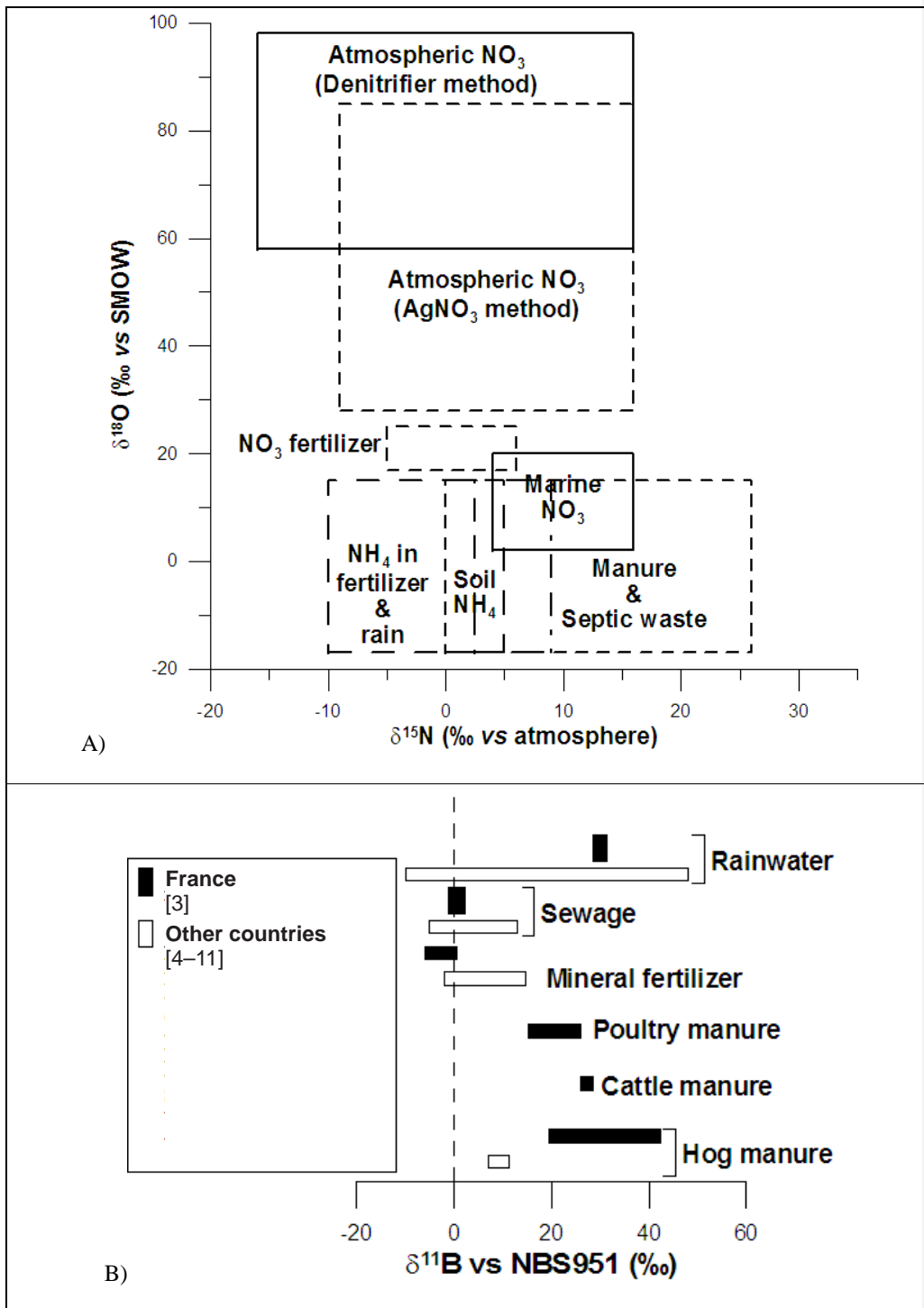

FIG. 1. Multi-isotope characterization of the main  $\text{NO}_3^-$  sources in groundwater. (A) The Kendall  $\delta^{15}\text{N}$ - $\delta^{18}\text{O}$  plot (adapted from Ref. [2]). (B)  $\delta^{11}\text{B}$  ranges.

The hydrolysis of urea produces a temporary rise in pH, favouring the formation of ammonia ( $\text{NH}_3$ ), which is easily lost to the atmosphere. Both the kinetic fractionation associated with this hydrolysis and the equilibrium fractionation between ammonia and ammonium ( $\text{NH}_4^+$ ) in solution result in strong  $^{15}\text{N}$  depletion of the  $\text{NH}_3$  lost from the system, leaving the remaining  $\text{NH}_4^+$  strongly enriched in  $^{15}\text{N}$ . Most of this  $\text{NH}_4^+$  is subsequently oxidized to  $^{15}\text{N}$ -enriched  $\text{NO}_3^-$ .

Animal manure is thus transformed into  $\text{NO}_3^-$  with  $\delta^{15}\text{N}$  values typically in the range of 5 to 35‰ ([3] and references therein).

Nitrate derived from the mineralization of reduced N forms ( $\text{NH}_4$ ,  $\text{NO}_3^-$ ) in the unsaturated zone has only two possible sources of isotopically distinctive oxygen — atmospheric oxygen and associated meteoric water oxygen. The aerobic nitrification pathway from  $\text{NH}_4$  to  $\text{NO}_3^-$  results in one third of the oxygen in  $\text{NO}_3^-$  being derived from air and two thirds being derived from water [12–15]. Thus,  $\text{NO}_3^-$  produced from nitrification of manure or fertilizer  $\text{NH}_4$  has a relatively narrow range of oxygen isotope values, with most of the variability attributed to the  $\delta^{18}\text{O}$  of local meteoric waters involved.

B isotope composition reflects the diet and physiology of local animals [7]. The values obtained from different studies (e.g. Ref. [3] and references therein) range from 7.2 to 42.4‰, with no clear discrimination between the different types of manure.

### 3.2. Mineral fertilizers

Nitrogenous fertilizer compounds (synthetic ammonia, ammonium, nitrate, and urea) are manufactured by different industrial processes using atmospheric nitrogen ( $\delta^{15}\text{N} = 0‰$ ) as the nitrogen source. Amberger & Schmidt [16] determined that nitrate fertilizers have distinctive  $\delta^{18}\text{O}$  values. Synthetic fertilizers for which oxygen is mainly derived from atmospheric oxygen ( $\delta^{18}\text{O} = 23.5‰$ ), have  $\delta^{18}\text{O}$  values ranging from 17 to 25‰. Nitrate derived from nitrification of ammonium fertilizers has a lower  $\delta^{18}\text{O}$  range (–5 to 15‰), which reflects the normally observed range for microbially produced nitrate in well-oxygenated soils. Another known, though less important, nitrate source from fertilizer manufacture comes from Chilean nitrate deposits, with a  $\delta^{15}\text{N}$  also close to 0‰ (from –5 to +5‰) and a  $\delta^{18}\text{O}$  value between 35‰ and 58‰ [17, 18].

Komor [7] initially reported  $\delta^{11}\text{B}$  values of –2 to 0.7‰ for ammonium nitrate and urea (n=3) and 14.8‰ for phosphate fertilizer (n=1). This range of  $\delta^{11}\text{B}$  values has been confirmed by more recent studies (e.g. [3, 19]).

### 3.3. Wastewater

It has often been observed that consumers (microbes to invertebrates) are 2–3‰ enriched in  $^{15}\text{N}$  relative to their diet. This  $\delta^{15}\text{N}$  increase in waste is mainly due to the excretion of low organic  $\delta^{15}\text{N}$  in urine or its equivalent [20]. Studies report  $\delta^{15}\text{N}$  values of  $\text{NO}_3^-$  in wastewater ranging from 4.3 to 23.5‰ ([3] and references therein).

Values of  $\delta^{11}\text{B}$  are generally in good agreement with data measured on sewage and non-marine evaporites such as sodium borate, which are generally between 0‰ and 10‰. Sodium borate is widely used for the production of sodium perborate, a whitening agent found in most laundry detergents.

Fig.1 summarizes the  $\delta^{15}\text{N}$ – $\delta^{18}\text{O}$ – $\delta^{11}\text{B}$  naturally observed in different pollution sources: fertilizers, animal manure and wastewater. While different pollution sources usually display similar (multi)-isotope ranges, it cannot be denied that each source has a regional variability, mainly linked to local environmental conditions during the nitrification process (for  $\delta^{15}\text{N}$  and  $\delta^{18}\text{O}$ ), and diet and physiology (for  $\delta^{11}\text{B}$ ). We would thus recommend that each new study start with the multi-isotope characterization of each potential  $\text{NO}_3^-$  pollution source on the studied watershed (which could then be compared to values obtained in literature).

#### 4. THE COUPLED $\delta^{15}\text{N}$ – $\delta^{18}\text{O}$ APPROACH: A FIRST STEP IN UNDERSTANDING NITRATE POLLUTION

Nitrate is the dominant nitrogen species in groundwater, and it may be derived from soil organic nitrogen, synthetic fertilizer, livestock waste, sewage effluent, and atmospheric precipitation. As discussed in the previous paragraphs, these sources produce nitrate with distinguishable  $\delta^{15}\text{N}$  values. However, a disadvantage of the single isotope approach is its inability to identify sources and transformation of  $\text{NO}_3^-$  in groundwater due to the non-conservative behaviour of nitrogen during infiltration. Analysis of  $\delta^{18}\text{O}$  has been developed to provide more information about nitrate cycling in groundwater. According to Andersson and Hooper [13], theoretically two of the oxygen atoms in nitrate derive from  $\text{H}_2\text{O}$  and the other from air during microbial nitrification. The isotopic composition of oxygen in chemical nitrate fertilizers is similar to that in air oxygen (about 23.5‰). The  $\delta^{18}\text{O}$  of  $\text{NO}_3^-$  only ranges from –2 to 6‰ when microbial nitrification occurs. Natural denitrification causes enrichment in both  $^{15}\text{N}$  and  $^{18}\text{O}$  in residual  $\text{NO}_3^-$ .

Of the long list of possible studies that used the dual isotope approach ( $\delta^{15}\text{N}$ – $\delta^{18}\text{O}$ ) to trace the origin and denitrification process of nitrate in water, we illustrate this method here with the textbook case of the Abbotsford aquifer (Canada) studied by L. Wassenaar et al. in 1995 and 2006 [21, 22].

Nitrate concentrations in the Abbotsford aquifer ranged from below detection to 151 mg/L  $\text{NO}_3^-$ , with a median concentration of 46 mg/L  $\text{NO}_3^-$  for the time period sampled. A majority of wells sampled had  $\text{NO}_3^-$  concentrations exceeding the accepted drinking water limit of 50 mg/L  $\text{NO}_3^-$ . Potential  $\text{NO}_3^-$  source materials were poultry manure and synthetic fertilizers. The  $\delta^{15}\text{N}$  of solid poultry manure (organic and  $\text{NH}_3\text{-N}$  forms) ranged between 7.9 and 8.6‰. Four brands of commonly used synthetic fertilizers had  $\delta^{15}\text{N}$  values of between –1.5 and –0.6‰. The  $\delta^{15}\text{N}$  of  $\text{NO}_3^-$  in the aquifer ranged between 8 and 16‰ (Fig. 2A), mostly compatible with inputs from manure and to a lesser extent from  $\text{NH}_4$  based fertilizers. The  $\delta^{18}\text{O}$  values of groundwater  $\text{NO}_3^-$ , in contrast, plotted in a narrow range with most  $\text{NO}_3^-$  samples having  $\delta^{18}\text{O}$  values of between 2 and 5‰ (Fig. 2B). This narrow range of  $\delta^{18}\text{O}$  values was within the range of  $\text{NO}_3^-$  produced by nitrification of manure N and  $\text{NH}_4$  fertilizer and had a similar range of  $\delta^{18}\text{O}$  values as  $\text{NO}_3^-$  in the upper part of the unsaturated zone below fertilized and manured raspberry fields, and beneath former manure piles. The  $\delta^{18}\text{O}$  data further suggested nitrification occurred in the summer months, with the  $\text{NO}_3^-$  produced during the summer subsequently flushed through the unsaturated zone and into the aquifer during fall recharge. A plot of  $\delta^{15}\text{N}$  versus  $\delta^{18}\text{O}$  (Fig. 2C) showed conclusively that: (i) nitrification of ammonium from manure was the main source of groundwater nitrate (mass balance indicates that less than 10% could be derived from septic wastes), and (ii) no significant natural remediation by bacterial denitrification was taking place in the aquifer (less than 5% of groundwater  $\text{NO}_3^-$  follows trends in a di-

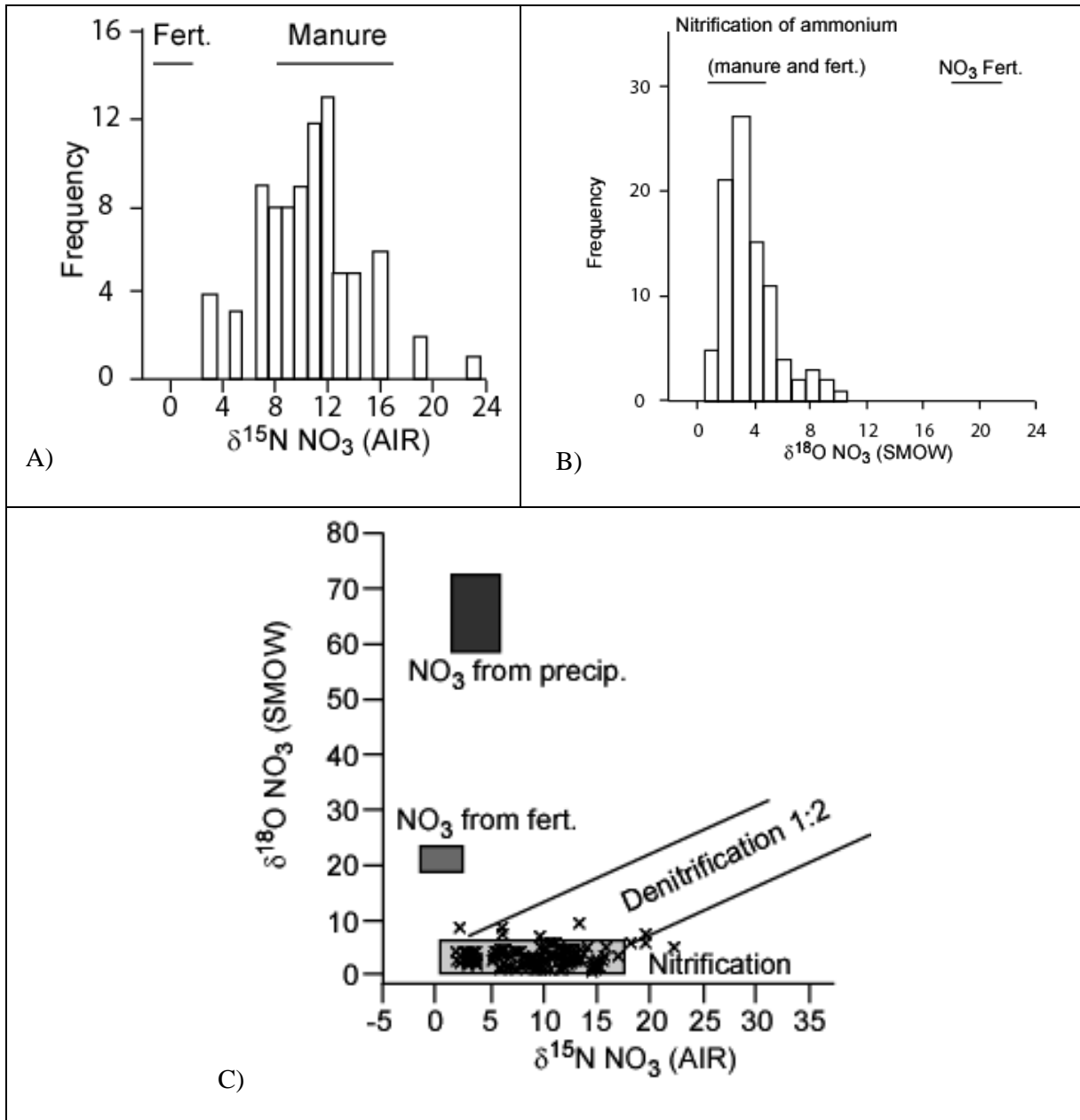

FIG. 2. A) Histogram of groundwater nitrate  $\delta^{15}\text{N}$ . Bars for fertilizer and manure from the Abbotsford area show a range of potential nitrate input ( $\delta^{15}\text{N}$  values); B) Histogram of groundwater nitrate  $\delta^{18}\text{O}$ . Bars show potential  $\delta^{18}\text{O}$  range for nitrate derived from nitrification of reduced N forms and for manufactured NO<sub>3</sub> fertilizers; C) Crossplot of  $\delta^{18}\text{O}$  versus  $\delta^{15}\text{N}$  (crosses). The two lines encompass the denitrification trend in 2:1 isotopic enrichment ratio. The isotope characteristics of the different NO<sub>3</sub> end-members are also reported.

reduction suggesting microbial remediation). The results of the study suggested that widespread NO<sub>3</sub> contamination of the Abbotsford aquifer would continue unless agricultural land management practices were dramatically changed. The author further suggested that attempts should be made to eliminate or minimize residual NO<sub>3</sub> levels in the soil and root zone, particularly in the fall and winter when soil NO<sub>3</sub> was flushed into the aquifer. Nevertheless, because the residence time of groundwater in the aquifer was in the order of decades, and because the aquifer did not appear to sustain any significant bacterial denitrification, the high NO<sub>3</sub> concentrations

currently observed in the aquifer would likely persist for decades even if anthropogenic surficial  $\text{NO}_3^-$  sources were eliminated.

However, since then publications have shown that the use of  $\delta^{18}\text{O}$  may present some limitations to tracing the cycling of nitrate due to complications induced by soil microbial processes (e.g. [23]), raising the need for potential complementary proxies, such as boron isotopes ( $\delta^{11}\text{B}$ ).

## 5. THE ADDED VALUE OF USING $\delta^{11}\text{B}$ : EXAMPLE OF THE ARGUENON CATCHMENT (FRANCE)

Groundwater in Brittany has the highest  $\text{NO}_3^-$  concentrations in France, commonly exceeding the 50 mg/L limit for drinking water. Two small adjacent catchments — Noë Ronde (33 ha) and Loges (125 ha) — were studied. They are located within the Arguenon watershed approximately 70 km northwest of Rennes (Brittany). The basement lithology is granitic gneiss to the north and Brioverian mica schist to the south.

The Arguenon river flows from an elevation of 150 m down to an elevation of 25 m, with an average discharge of  $\approx 1 \text{ m}^3/\text{s}$ . The piezometric level in most of the watershed follows the surface topography, which suggests a fairly low overall aquifer permeability, as is common in hard rock environments. Most sample wells are screened in the weathered zone or in both the weathered zone and the fresh basement rock.

Local agriculture includes a high level of indoor pig farming, poultry and cattle breeding, as well as cultivation, for which the land is extensively fertilized. Domestic wastewater is treated in a sewage treatment plant (direct discharge to infiltration ponds) downstream from the village of St. Igneuc.

In order to characterize the non-polluted state of the watershed's groundwater, water from the Bonne Fontaine spring, located in the forested part of the Arguenon watershed away from any human influence, was analyzed. It has a low specific conductance ( $195 \mu\text{S}/\text{cm}$ ; [3] and a sodium chloride composition inherited from rainwater derived from sea salts. The corresponding  $\delta^{15}\text{N}$  is  $6.7 \pm 0.2\text{‰}$ , consistent with values from literature for unpolluted groundwater (e.g. [24, 25]). Values of  $\delta^{11}\text{B}$  ( $38.5 \pm 0.4\text{‰}$ ) are consistent with the seawater value of  $39.5\text{‰}$  [26] and therefore display a marine origin.

The  $\text{NO}_3^-$  concentrations in groundwater vary between 3.2 and 245 mg/L, with a mean value of  $106 \pm 78 \text{ mg/L}$  (median value of 104 mg/L), which greatly exceeds the 50 mg/L drinking water level. Chemical correlations of B and  $\text{NO}_3^-$  (Fig. 3A) indicate that data plot within a three end-members model is delimited by unpolluted groundwater (such as recharge), wastewater and nitrate resulting from the spreading of animal manure. The  $\delta^{15}\text{N}$  in groundwater samples varies from between 2.7 to 21 ( $\pm 0.2$ )‰, within the range of  $\delta^{15}\text{N}$  pollution sources from the catchment ( $-1.6$  to  $33.2\text{‰}$ ). The  $\delta^{15}\text{N}$  of the most contaminated groundwater ( $\text{NO}_3^- > 200 \text{ mg/L}$ ), the N isotope composition of which may be assumed to be most similar to the initial values of pollution sources, independent of subsequent mixing or denitrification, is between 8.1 and 12.5‰. The  $\delta^{11}\text{B}$  varies between 14.5 and 42.5‰, matching the range of animal manure (14.8 to 42.4‰).

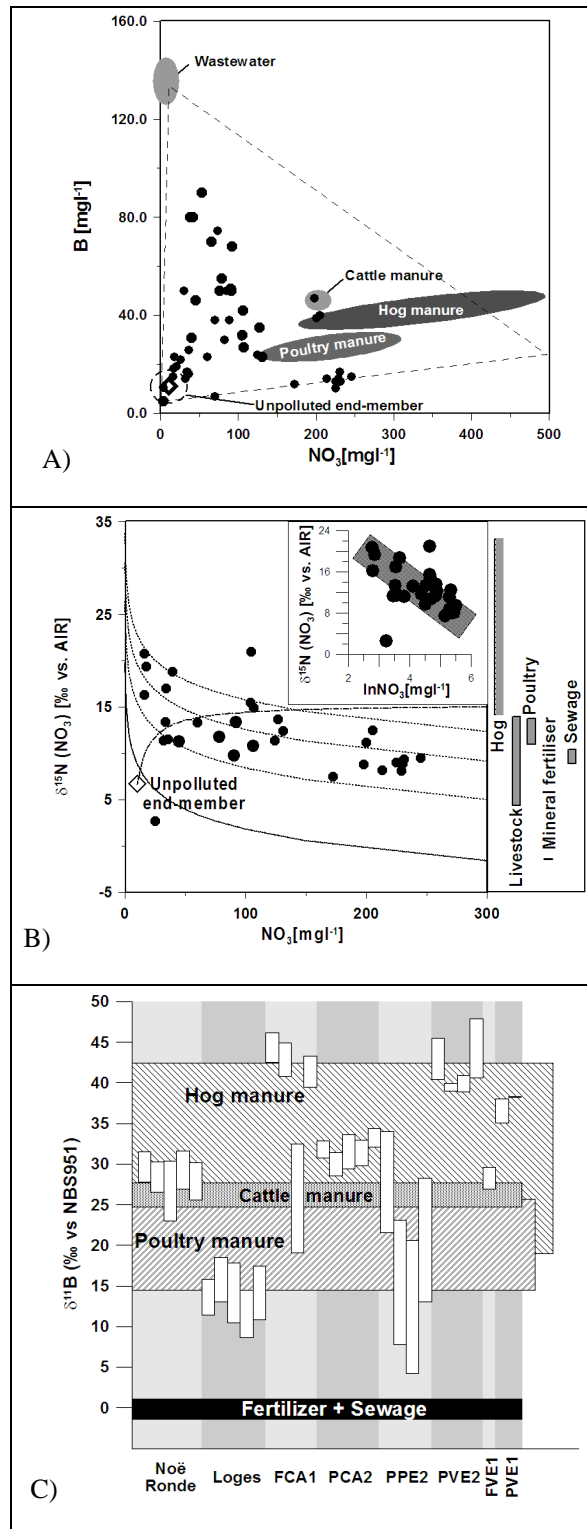

FIG. 3. (A)  $B$ - $NO_3^-$  variations within the groundwater samples. Ranges obtained for the different pollution sources are also reported; (B)  $\delta^{15}N$ - $NO_3^-$  concentration variance in groundwater samples. Specific theoretical denitrification and pollution (i.e. binary mixing) models are also shown. The Rayleigh distillation calculations for denitrification take into account an  $\epsilon$  value of  $-3.1\%$  and an initial  $NO_3^-$  concentration of  $300$  mg/L. The insert shows linear relationships between  $\delta^{15}N$  and  $\ln(NO_3^-)$  typical for denitrification reactions; (C) Determination of the  $\delta^{11}B$  of the main pollution source for each sampling site based on the mixing model. For each site, several samples were taken during the hydrological cycle; they are plotted in chronological order for each site, allowing the monitoring of pollution source variations along the hydrological cycle.



We observe a rough linear trend of increasing  $\delta^{15}\text{N}$  with the decreasing logarithm of  $\text{NO}_3^-$  concentrations ( $\delta^{15}\text{N} = -3.1 \ln \text{NO}_3^- + 26.1\text{‰}$ ;  $r = 0.77$ ; Fig. 3B), which indicates natural denitrification within the catchment (affecting the  $\delta^{15}\text{N}$  of nitrate in groundwater). The slope of the plotted line yields an approximate enrichment factor of  $\varepsilon = -3.1 \pm 0.5\text{‰}$ , compatible with rapid denitrification. The unpolluted end-member lies outside of this trend, with low  $\text{NO}_3^-$  concentrations and  $\delta^{15}\text{N}$ . We also calculated denitrification curves for the various pollution sources. For each pollution source, the initial  $\text{NO}_3^-$  concentration,  $C_0$ , is arbitrarily set at 300 mg/L (higher than the highest measured groundwater concentration), and the enrichment factor is at  $-3.1\text{‰}$ , as previously determined. The following conclusions are drawn from the  $\delta^{15}\text{N}$  vs.  $\text{NO}_3^-$  variations: (1) The  $\delta^{15}\text{N}$  of samples with the highest concentrations are assumed to be closest to their  $\text{NO}_3^-$  source composition(s) (the flat part of the denitrification curve), and lie in the domain of animal manure as well as sewage water (but at higher concentrations). (2) Most of the samples plot within the range of animal manure influenced by nitrification. Fertilizers seem to have a negligible effect. (3) All sample values can be explained when both mixing (dilution) and denitrification are considered.

The behavior of B in the Arguenon system is relatively conservative and essentially reflects mixing. It is therefore possible to back-calculate the  $\delta^{11}\text{B}$  of the pollution source using a simple binary mixing model involving the sample and the baseline end-member. Calculated  $\delta^{11}\text{B}$  values obtained for each pollution source (Fig. 3C), corresponding to samples taken regularly at each site during an entire hydrological cycle for example, one year) vary from  $4.2 \pm 0.1\text{‰}$  to  $47.9 \pm 0.4\text{‰}$ . This wide range of  $\delta^{11}\text{B}$  is comparable with almost all types of pollution sources. The calculated ranges indicate animal manure is the main contaminant component of  $\text{NO}_3^-$  in the groundwater of the Arguenon watershed, which is consistent with conclusions based on N isotopes. Among them, hog manure seems to be a major contributor. Two samples indicate that the contribution of the sewage end-member is greater, particularly because N isotopes exclude mineral fertilizer as a major pollution source. For one sample (FCA1), the origin of the pollution is either a scavenger well located on the plot, or contamination from the nearby village of St. Igneuc.

Monitoring shows that  $\text{NO}_3^-$  sources are almost constant throughout the entire hydrological cycle, except in two samples: one that shows the contribution of a low- $\delta^{11}\text{B}$  source, and another with a varying contribution of sewage effluent. This method allows for assessment of variations of pollution source contributions along the hydrological cycle.

## 6. COST/BENEFITS OF THE ISOTOPE APPROACH

Since it has been demonstrated that isotopes are a successful tool for tracking sources of nitrate pollution in groundwater, it remains necessary to assess whether or not this translates into an economic benefit. To evaluate the cost/benefit of using isotopes, we took the example of the Alsace aquifer in eastern France [27] to project potential cost reductions (or avoidance) that keep the application of an isotope control of nitrate pollution at an acceptable level. Of a total population of 1.7 million in the region, 432 000 are affected by nitrate pollution of the aquifer. This has resulted in total restoration costs of €26 million over the period 1988–2002. Stricter pollution monitoring in identified risk areas could have prevented a substantial part of these costs, which are borne by all sectors of the economy. For farmers, the cost has been €2.5 million, mainly in changes to farming practices. And a major beer manufacturer had to invest €10 million in a new treatment plant and necessary connections. Householders have paid about

€14 million in extra costs. Generally speaking, the cost of nitrate treatment for 25 plants in various regions in France resulted in additional costs of €0.24 to 0.28 per cubic meter for abstracted water, and €0.19 to 0.22 per inhabitant per year.

Due to the type of instruments used (such as isotope ratio mass spectrometers), isotope analysis is generally more expensive than chemical analysis. However, the overall cost of such an approach is less expensive, as the isotope approach requires less monitoring stations and a lower frequency of sampling (compared to ‘classical’ nitrate concentration monitoring). It also provides more information in terms of precisely discriminating pollution sources, and quantifying their respective source contributions in a river basin. In general, a typical multi-isotope study of an aquifer such as the Alsace aquifer costs less than €1 million.

Evaluation of the cost/benefit ratio of isotope monitoring in terms of environmental impact can be made keeping in mind possible cost savings due to better water management, such as projected restoration costs for the various sectors involved (more expensive farming practices, change to industrial installations or water treatment plants, costs for connecting households to treatment plants).

## 7. CONCLUSIONS: THE ADVANTAGES OF A MULTI-ISOTOPE APPROACH

The examples presented here confirm that the joint use of nitrogen, oxygen and boron isotope systematics usually provides clear evidence of main groundwater pollution sources due to source specific pollution isotope signatures (coupled  $\delta^{15}\text{N}$ – $\delta^{18}\text{O}$  and  $\delta^{11}\text{B}$ ) of the different types of  $\text{NO}_3^-$  sources (animal manure, mineral fertilizers and wastewater; Fig. 1).

When nitrate is not affected by natural denitrification,  $\delta^{15}\text{N}$ ,  $\delta^{18}\text{O}$  and  $\delta^{11}\text{B}$  can be easily described by a mixing equation system (i.e. pollution):

$$\begin{cases} C = (C_1 + qC_2)/(1 + q) \\ \delta = (C_1\delta_1 + qC_2\delta_2)/(C_1 + qC_2) \end{cases}$$

where  $C_1$ ,  $C_2$ ,  $\delta_1$ ,  $\delta_2$  are the concentrations and isotopic compositions of the mixing components (i.e., the polluted and non-polluted end-members) and  $q$  is the mixing ratio  $m_1/m_2$  of the two groundwater masses. When plotting this mixing trend in the  $\delta$  vs.  $1/C$  diagram,  $\delta = a/C + b$ , where  $a = C_1C_2(\delta_1 - \delta_2)/(C_2 - C_1)$  and  $b = \delta_2 - C_1(\delta_1 - \delta_2)/(C_2 - C_1)$ . Thus,  $b$  is an estimate of the isotopic composition of the polluted end-member (three  $b$  values are obtained, one for  $\delta^{15}\text{N}$  vs.  $1/\text{NO}_3^-$ , one for the  $\delta^{18}\text{O}$  vs.  $1/\text{NO}_3^-$  and one for  $\delta^{11}\text{B}$  vs.  $1/\text{B}$ ). The combination of these three values will strongly indicate the origin of  $\text{NO}_3^-$ .

The coupling of the  $\delta^{15}\text{N}$ – $\delta^{18}\text{O}$  analysis provides an equation system in which pollution and natural denitrification processes can usually be deciphered when the process occurs. However, by including boron isotopes, the identification of  $\text{NO}_3^-$  source(s) rises. The main limitation is that mineral fertilizers and wastewater have overlapping  $\delta^{11}\text{B}$  ranges (centered around 0‰; see Fig. 1B). The concentration of some specific elements such as chlorine (found in high concentrations in sewage) provide additional information to decrease uncertainty.

## REFERENCES

- [1] PAUWELS, H., FOUCHER, J.C., KLOPPMANN, W., Denitrification and mixing in a schist aquifer: Influence on water chemistry and isotopes, *Chem. Geol.* **168** (2000) 307–324.
- [2] KENDALL, C., ELLIOTT, E.M., WANKEL, S.D., “Tracing anthropogenic inputs of nitrogen to ecosystems”, *Stable Isotopes in Ecology and Environmental Science*, 2nd edition (MICHENER, R., LAJTHA, K., Eds), Blackwell Publishing (2007) 375–449.
- [3] WIDORY, D., et al., Nitrates in groundwater: an isotopic multi-tracer approach, *J. Contam. Hydrol.* **72** (2004) 165–188.
- [4] BARTH, S., Application of boron isotopes for tracing sources of anthropogenic contamination in groundwater, *Water Res.* **32** (1998) 685–690.
- [5] BASSET, R.L., BUSZKA P.M., DAVIDSON G.R., CHONG-DIAZ D., Identification of groundwater solute sources using boron isotopic composition, *Environ. Sci. Technol.* **29** (1995) 2915–2922.
- [6] GELLENBECK, D.J., Isotopic Compositions and Sources of Nitrate in Ground Water from Western Salt River Valley, Arizona, U.S.G.S., *Water Resource Investigation Report* (1994) 94–4063.
- [7] KOMOR, S.C., Boron contents and isotopic compositions of hog manure, selected fertilizers, and water in Minnesota, *J. Environ. Qual.* **26** (1997) 1212–1222.
- [8] LEENHOUTS, J.M., BASSETT R.L., MADDOCK III T., Utilization of intrinsic boron isotopes as co-migrating tracers for identifying potential nitrate contamination sources, *Ground Water* **36** (1998) 240–250.
- [9] SCOTT, P.S., Effluent recharge to the upper Santa Cruz River flow plain aquifer, Santa Cruz County, Arizona, *Doctoral thesis, University of Arizona, Tucson, Arizona* (1996).
- [10] VENGOSH, A., HEUMANN K.G., JURASKE S., KASHER R., Boron isotope application for tracing sources of contamination in groundwater, *Environ. Sci. Technol.* **28** (1994) 1968–1974.
- [11] VENGOSH, A., BARTH S., HEUMANN K.G., EISENHUT S., Boron isotopic composition of freshwater lakes from Central Europe and possible contamination sources, *Acta Hydrochim. Hydrobiol.* **27** (1999) 416–421.
- [12] ALEEM, M.I.H., HOCH G.E., VARNER J.E., Water as the source of oxidant and reductant in bacterial chemosynthesis, *Biochemistry* **54** (1965) 869–873.
- [13] ANDERSON, K.K., HOOPER, A.B., O<sub>2</sub> and H<sub>2</sub>O are each the source of one O in NO<sup>o</sup> produced from NH<sub>3</sub> by Nitrosomas: <sup>15</sup>N–NMR evidence, *FEBS Letters* **64** (1983) 236–240.
- [14] HOLLOCHER, T.C., Source of oxygen atoms of nitrate in the oxidation of nitrite by nitrobacter agillis and evidence against a P–O–N anhydride mechanism in oxidative phosphorylation, *Arch. Biochem. Biophys.* **233** (1981) 721–127.
- [15] YOSHINARI, T., WAHLEN, M., Oxygen isotope ratios in N<sub>2</sub>O from nitrification at a wastewater treatment facility, *Nature* **317** (1985) 349–350.

- [16] AMBERGER, A., SCHMIDT, H.L., Natürliche isotopengehalte von nitrat als indikatoren für dessen herkunft, *Geochim. Cosmochim. Acta* **51** (1987) 2699–2705.
- [17] BÖHLKE, J.K., MROCKOWSKI, S.J., COPLEN, T.B., Oxygen isotopes in nitrate: New reference material for  $^{18}\text{O}$ : $^{17}\text{O}$ : $^{16}\text{O}$  measurements and observations on nitrate-water equilibration, *Rap. Comm. Mass Spectrom.* **17** (2003) 1835–1846.
- [18] VITORIA, L., OTERO, N., SOLER, A., CANALS, A., Fertilizer characterization: Isotopic data (N, S, O, C, and Sr), *Environ. Sci. Technol.* **38** (2004) 3254–3262.
- [19] WIDORY, D., PETELET-GIRAUD, E., NEGREL, P., LADOUCHE, B., Tracking the sources of nitrate in groundwater using coupled nitrogen and boron isotopes: A synthesis, *Environ. Sci. Technol.* **39** (2005) 539–548.
- [20] WOLTERINK, T.J., Identifying sources of subsurface nitrate pollution with stable nitrogen isotopes, EPA-600/4-79-050, US Environmental Protection Agency, Washington, DC (1979) 150 pp.
- [21] WASSENAAR, L.I., Evaluation of the origin and fate of nitrate in the Abbotsford aquifer using the isotope of  $^{15}\text{N}$  of  $^{18}\text{O}$  in  $\text{NO}_3^-$ , *Appl. Geochem.* **10** (1995) 391–405.
- [22] WASSENAAR, L.I., HENDRY, M.J., HARRINGTON, N., Decadal geochemical and isotopic trends for nitrate in a transboundary aquifer and implications for agricultural beneficial management practices, *Environ. Sci. Technol.* **40** (2006) 4626–4632.
- [23] MENGIS, M., WALTHER, U., BERNASCONI, S., WEHRLI, B., Limitations of using  $\delta^{18}\text{O}$  for the source identification of nitrate in agricultural soils, *Environ. Sci. Technol.* **35** (2001) 1840–1844.
- [24] SHEARER, G.B., KOHL, D.H., COMMONER, B., The precision of determination of the natural abundance of nitrogen-15 in soils, fertilizers, and shelf chemicals, *Soil Sci.* **118** (1974) 308–316.
- [25] HEATON, T.H.E., Isotopic studies of nitrogen pollution in the hydrosphere and atmosphere: a review, *Chem. Geol.* **59** (1986) 87–102.
- [26] BARTH, S., Boron isotope variations in nature: a synthesis, *Geology Rundsch* **82** (1993) 640–651.
- [27] KLOPPMANN.W., WIDORY.D., PAUWELS.H., SCHOMBURGK.S., ELSASS.P., GRAVELINE.N., Inventaire transfrontalier 2003 de la qualité des eaux souterraines de la vallée du Rhin supérieur: Etude isotopique (N, B) de l'origine des nitrates, Rapport final, Report: BRGM/RP-54028-FR (2005).



# **SIMULTANEOUS MEASUREMENT OF NITROGEN AND OXYGEN ISOTOPES OF NITRATE TO EVALUATE NITRATE SOURCES AND PROCESSES IN CATCHMENTS**

**NOBUHITO OHTE**

Graduate School of Agricultural and Life Sciences,  
The University of Tokyo,  
Tokyo, Japan

**TOSHI NAGATA, ICHIRO TAYASU**

Center for Ecological Research,  
Kyoto University,  
Ohtsu, Japan

**AYATO KYOZU, CHIKAGE YOSHIMIZU**

CREST, Japan Science and Technology Agency,  
Center for Ecological Research,  
Kyoto University,  
Ohtsu, Japan

**KEN'ICHI OSAKA**

Carbon and Nutrient Cycles Division,  
National Institute for Agro-Environmental Sciences,  
Tsukuba, Japan

## **Abstract**

We review studies on applied isotope analytical techniques for identifying sources and transformations of river nitrate ( $\text{NO}_3^-$ ) to examine the influences of water pollution, excess nutrient (nitrogen) loads and ecosystem disturbances in river systems. We also discuss the current status and future perspectives of the application of  $\text{NO}_3^-$  isotope measurements to the assessment of river nutrients. Our review shows that in recent years simultaneous measurements of nitrogen and oxygen isotopes ( $\delta^{15}\text{N}$  and  $\delta^{18}\text{O}$ ) of  $\text{NO}_3^-$  have been increasingly used to identify the sources and pathways of nitrogen in river systems. The  $\delta^{15}\text{N}$  value of  $\text{NO}_3^-$  is a useful indicator to evaluate the contributions of sewage and/or animal waste to  $\text{NO}_3^-$  load, and the  $\delta^{18}\text{O}$  value can be used for estimation of the contribution of  $\text{NO}_3^-$  derived through atmospheric deposition. The microbial denitrification method is currently a most useful tool to measure the  $\delta^{15}\text{N}$  and  $\delta^{18}\text{O}$  values of  $\text{NO}_3^-$  simultaneously, because of its capability for high throughput of samples. This method allows us to conduct a comprehensive investigation of spatial and temporal variations and mechanisms of nitrogen transport and transformation in rivers and catchments in more precise and effective manner.

## **1. INTRODUCTION**

Nitrogen (N) is an essential nutrient in various biomes and ecosystems, but excess N can act as a pollutant that can seriously alter the conditions and functions of natural ecosystems. Atmospheric deposition is a major pathway through which anthropogenic inorganic N enters into terrestrial ecosystems [1, 2]. In aquatic ecosystems, excess N fertilizer and wastewater originated from farms, livestock facilities, and residential areas are additional major point and non-point

sources of N inputs to river systems. Excess nitrate ( $\text{NO}_3^-$ ) and ammonium ( $\text{NH}_4^+$ ) inputs often cause eutrophication in rivers, lakes, and estuaries, resulting in extreme algal bloom [3–5].

A load factor method (calculating cumulative loads using previously determined load per unit area and unit time (load factor) measurements for each single land use) has often been used to estimate N loads (e.g. [6–8]). However, there are many uncertainties in the calculation of load factors for various land uses. In general, the N load in rivers depends on terrestrial factors (such as hydrology, geomorphology, and land use) as well as in-stream biogeochemical processes. To estimate N loads for each of the different land uses and evaluate in-stream biogeochemical processes in river systems, the mass-balance approach is used based on the concentrations of various N compounds and discharge rates. In addition, several models have been developed to estimate N mass balances in rivers [9–12].

Isotope analysis of N compounds is a powerful tool for evaluating N dynamics in catchments; the use of isotopes can reduce uncertainties in the application of mass balance models by identifying N sources and sinks and determining transformation processes. The  $\delta^{15}\text{N}$  value of N compounds reflects their sources, physical and chemical reactions that cause isotopic fractionation, and biological reactions such as uptake, nitrification, denitrification, and assimilation in food webs. In addition, the oxygen isotope ratio of  $\text{NO}_3^-$  constitutes an additional useful tracer. The  $\delta^{18}\text{O}$  value of  $\text{NO}_3^-$  differs significantly between  $\text{NO}_3^-$  generated biologically in soils and/or aquatic ecosystems versus that produced chemically in the upper atmosphere [13].

Therefore, spatial and temporal variations in isotope signals, especially multi-isotope signatures, can provide insightful information into N transformation, such as nitrification and denitrification, and transportation and mixing of N compounds in ecosystems. Isotope tracer techniques have been useful for the assessment of N pollution in rivers and lakes by distinguishing N from different origins and of N undergoing different processes. Since the 1990s, multi-isotope techniques have been used for research purposes to evaluate N transport and transformation processes, but not for river management purposes.

The main objectives of this section are to: (i) review studies on river environments that evaluated water pollution, excess nutrient (or N) loads and ecosystem disturbances applying  $\text{NO}_3^-$  isotope techniques; (ii) discuss the current status of the isotope application of  $\text{NO}_3^-$  in river studies. We also describe a powerful technique, the simultaneous measurement of N and oxygen (O) isotopes of  $\text{NO}_3^-$ , which has been increasingly used, and describe a case study that evaluated the nutrient status of rivers in a Japanese watershed using this technique. Finally, we present future perspectives on the application of  $\text{NO}_3^-$  isotopes to nutrient assessment in rivers.

## 2. APPLICATION OF NITROGEN ISOTOPES IN AQUATIC ECOSYSTEMS

Isotope measurements of various N compounds in aquatic ecosystems were first conducted in the 1950s [14–15]. Since the 1970s,  $\delta^{15}\text{N}$  has been used as an index to indicate the degree of N pollution in rivers and lakes, because the  $\delta^{15}\text{N}$  of organic and inorganic N compounds from manure and septic waste is often markedly higher than that of precipitation, fertilizers and natural soil (e.g. Ref. [16] for fertilizer; [17] for atmospheric deposition; [18] for septic waste). Further, because many reactions involving N notably cause isotopic fractionation, enriching  $^{14}\text{N}$  in products, the bulk  $\delta^{15}\text{N}$  value in residual N compounds usually increases during each process [19, 20]. Ammonia volatilization and denitrification may occur in eutrophic systems



that have high concentrations of inorganic N. These processes occur under certain circumstances, such as high pH in the case of volatilization, and dissolved oxygen content  $<2$  mg/L for denitrification. These processes also increase the  $\delta^{15}\text{N}$  value of residual N [21, 22]. Many studies have shown that the  $\delta^{15}\text{N}$  value of dissolved organic and inorganic N and organic matter increases as eutrophication proceeds in aquatic ecosystems in lakes, reservoirs, and coastal basins [22, 23]. In the lakes and reservoirs of North America, which continuously receive anthropogenic N inputs, there were positive correlations between dissolved inorganic N concentration and the  $\delta^{15}\text{N}$  of various N compounds [24–26]. For example, Valiela et al. [27] and Carmichael et al. [28] conducted statistical analyses, using data on land use, population, and economic parameters, to estimate effects of anthropogenic N inputs on the  $\delta^{15}\text{N}$  value of organic matter and organisms. These studies showed that the  $\delta^{15}\text{N}$  value of organic matters increased with increasing anthropogenic N loads. However, when ammonium concentrations are high under extremely eutrophic conditions, the  $\delta^{15}\text{N}$  value of organic matter decreases due to large isotope fractionation associated with ammonium uptake by phytoplankton [29–31].

## 2.1. Measuring nitrogen and oxygen isotopes of nitrate

Before the mid-1990s, the ammonium distillation method [32] was widely used to measure N isotopes of  $\text{NO}_3^-$  in natural waters. This method involves the reduction of  $\text{NO}_3^-$  to  $\text{NH}_4^+$ , which is distilled and concentrated as ammonium sulfate salt and then combusted to produce  $\text{N}_2$  gas for isotope measurement, using an isotope ratio mass spectrometer. Brooks et al. [33] developed the ammonium diffusion method for preparing soil KCl extracts for  $\delta^{15}\text{N}$  measurements for  $\text{NH}_4^+$  and  $\text{NO}_3^-$ . Sigman et al. [34] modified the ammonium diffusion method to apply it to natural abundance level measurements of  $\delta^{15}\text{N}$  in seawater  $\text{NO}_3^-$ . The ammonia diffusion method has required less labor and less sample volume than the ammonium distillation method, and has facilitated sample preparation. Dissolved  $\text{NO}_3^-$  is reduced to ammonium in a closed bottle, and the gaseous ammonia is trapped by a glass fiber filter impregnated with acid solution. The N isotope ratio of the ammonium ions on the filter is measured, using an isotope ratio mass spectrometer connected to an elemental analyzer (EA-IRMS) through a continuous flow system.

Silva et al. [35] proposed a new method using ion exchange resins. In this method,  $\text{NO}_3^-$  ions in water samples are concentrated via adsorption on an anion exchange column. Adsorbed  $\text{NO}_3^-$  ions are removed from the resin by adding hydrochloric acid. This solution is neutralized with silver oxide, and precipitated silver  $\text{NO}_3^-$  is extracted using freeze dehydration. Finally, the  $\delta^{15}\text{N}$  value of the silver  $\text{NO}_3^-$  is measured using an EA-IRMS. For the  $\delta^{18}\text{O}$  value measurement, silver nitrate should be very carefully prepared, eliminating all O-bearing compounds other than  $\text{NO}_3^-$  [36]. Silver nitrate is combusted with fine graphite powder in a tube to generate  $\text{CO}_2$  from the oxygen of  $\text{NO}_3^-$ , and then the  $\delta^{18}\text{O}$  value of  $\text{CO}_2$  is determined using an IRMS. A pyrolysis (thermal conversion) reactor coupled with an IRMS has been used to measure the  $\delta^{18}\text{O}$  values of silver nitrate in previous studies (e.g. Refs [37–39]). Accoe et al [40] pointed out recently that accurate  $\delta^{18}\text{O}$  analysis of N-containing compounds (like  $\text{NO}_3^-$ ) by TC-EA (Thermal Conversion – Elemental Analyzer)-IRMS may be complicated because of interference of the  $\text{N}_2$  peak on the  $m/z$  30 signal of the CO peak.

With this method using ion exchange resins, it is relatively easy to prepare samples for isotope measurement. Moreover, since samples are concentrated using an ion exchange column in situ (in the field) after the collection of samples, it is no longer necessary to transport a large volume of water to the laboratory. Chang et al. [41] and many others (e.g. Refs [26, 42–43]) applied Silva's method to determine the  $\delta^{18}\text{O}$  value of  $\text{NO}_3^-$  of fresh water using same ion ex-

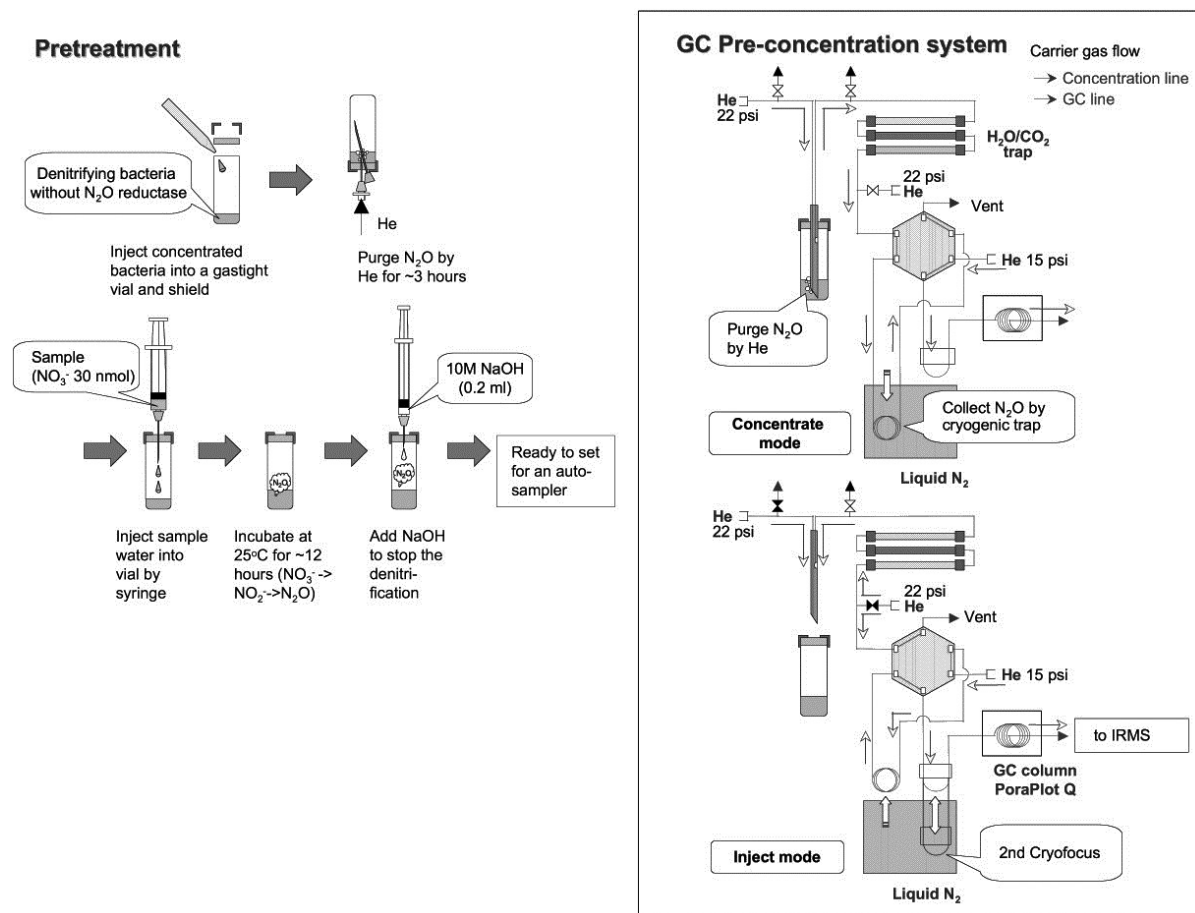

FIG. 1. Schematic illustration of the denitrifier method. Sample pretreatment (left) and GC pre-concentration system before injection into the isotope ratio mass spectrometer (right).

change columns. One disadvantage of this method was high cost due to the need to use pure silver oxide.

Compared to the methods described above, a ‘denitrification method’, which is used to measure the  $\delta^{15}\text{N}$  and  $\delta^{18}\text{O}$  values of  $\text{NO}_3^-$  simultaneously, has many advantages [44, 45]. Dissolved  $\text{NO}_3^-$  is reduced in a glass vial by denitrifying bacteria, which cannot reduce nitrous oxide gas ( $\text{N}_2\text{O}$ ), to nitrogen gas ( $\text{N}_2$ ). The  $\text{N}_2\text{O}$  gas is fed to a mass spectrometer for isotopic measurement through a continuous flow system. Fig. 1, for example, shows the analytical system with Delta Plus XP (Thermo Fisher Scientific) used in the Center for Ecological Research, Kyoto University [46]. In this laboratory, isotopic data of  $\text{NO}_3^-$  are calibrated using USGS34, USGS35 [47], and an internal  $\text{KNO}_3$  laboratory standard calibrated at the United States Geological Survey, Stable Isotope Laboratory in Menlo Park, California. Measurements were within  $\pm 0.14\text{‰}$  for  $\delta^{15}\text{N}$  and  $\pm 0.66\text{‰}$  for the  $\delta^{18}\text{O}$  of an internal  $\text{KNO}_3$  laboratory standard.

To produce  $\text{N}_2\text{O}$  gas from dissolved  $\text{NO}_3^-$  in the sample, other reducing methods have also been developed, using ultraviolet (UV) light or spongy cadmium to reduce  $\text{NO}_3^-$  to nitrite ( $\text{NO}_2^-$ ), using azide or hydroxylamine as catalyst for the  $\text{NO}_2^- \rightarrow \text{N}_2\text{O}$  reduction [48–50]. The sample preparation for the denitrification method takes less time than the previous method using an anion exchange column. While the former method usually is usually needed to prepare samples

for measuring  $\delta^{15}\text{N}$  and  $\delta^{18}\text{O}$  separately, both isotopic values can be measured simultaneously using the denitrification method, resulting in a higher throughput in  $\text{NO}_3^-$  isotopic analyses.

The most important advantage of the denitrification method is that the required sample volume is less than 1/100 of the volume required using previous methods. This feature is critically important for samples that contain only minimal amounts of  $\text{NO}_3^-$ . Therefore, this method enables the measurement of  $\text{NO}_3^-$  isotopes in samples such as ice cores [51] and soil pore water (Osaka et al. submitted) which were difficult to analyze using other methods. The denitrification method can be also used for seawater because this method is insensitive to the ionic strength of a solution (e.g. [44, 45, 52, 53]). Moreover, unlike with previous methods, dissolved organic N does not act as a contaminant in N isotopic measurements when the denitrification method is used because bacteria only denitrify  $\text{NO}_3^-$ . Sample preparation is markedly faster for the denitrification method than for the previous methods. However, this method has also several limitations: (1) special techniques are required for the storage and maintenance of the denitrifying bacteria, and (2) the presence of  $^{17}\text{O}$  in  $\text{NO}_3^-$  molecules, especially in rainwater, interferes with the  $\delta^{15}\text{N}$  measurement of  $\text{N}_2\text{O}$  [54]. Approaches for overcoming this limitation were introduced in Refs [55, 56].

With the denitrification method, it is only possible to measure the total  $\delta^{15}\text{N}$  or  $\delta^{18}\text{O}$  values of combined  $\text{NO}_3^-$  and  $\text{NO}^{\bullet}$  in a solution. Therefore, when  $\text{NO}_2$  concentrations are high relative to  $\text{NO}_3^-$ , caution is needed for the use of measured  $\delta^{15}\text{N}$  and  $\delta^{18}\text{O}$  values. If only the measurement of  $\delta^{18}\text{O}$  of  $\text{NO}_3^-$  is required, pre-separation of  $\text{NO}_3^-$  vs.  $\text{NO}^{\bullet}$  is needed. A method for  $\text{NO}_2$  removal in  $\text{NO}_3^-$ -N and -O isotope analyses using the denitrification method was proposed in Ref. [57].

## 2.2. Advantages of the simultaneous measurement of $\delta^{15}\text{N}$ and $\delta^{18}\text{O}$ in nitrate

In temperate climates,  $\text{NO}_3^-$  is relatively mobile in soil systems due to its solubility and inadsorbability, and it is the major form of dissolved N in streams and rivers, except in heavily reduced aquatic systems. Tracing of  $\text{NO}_3^-$  is thus very useful for understanding nutrient dynamics and transport in aquatic systems in temperate climates. However, there is usually no significant difference in the  $\delta^{15}\text{N}$  value of  $\text{NO}_3^-$  between precipitation and synthetic fertilizers [20]. In addition, the  $\delta^{15}\text{N}$  values of soil water  $\text{NO}_3^-$  are often similar to that of precipitation.

As mentioned above, the  $\delta^{18}\text{O}$  measurement of  $\text{NO}_3^-$  was developed in the late 1980s and has been used to overcome this limitation, and to reveal new characteristics of  $\text{NO}_3^-$  in various environments [18, 36, 58]. Kendall et al. [59] summarized previous reports, and proposed a diagram of the  $\delta^{15}\text{N}$  and  $\delta^{18}\text{O}$  ranges of major sources of  $\text{NO}_3^-$  (Fig. 2). The range of  $\delta^{18}\text{O}$  of  $\text{NO}_3^-$  in precipitation is large (60–100‰ using the denitrification method) and generally higher than that in other sources. This range in  $\delta^{18}\text{O}$  may be due to various atmospheric processes that produce nitrogen oxides. Isotope fractionation associated with  $\text{NO}_3^-$  formation occurs during thunderstorms, in the incomplete combustion of fossil fuels in power plants and vehicle exhaust, and through atmospheric photochemical reactions [17, 60]. A likely mechanism for high  $\delta^{18}\text{O}$  values of  $\text{NO}_3^-$  is the reaction of ozone ( $\text{O}_3$ ) with nitrogen gas ( $\text{N}_2$ ), producing  $\text{NO}_x$  [61, 62]. As presented in Fig. 2, the ranges of  $\delta^{18}\text{O}$  values observed using the denitrification method are higher than those analyzed using closed tube or pyrolysis methods for converting silver nitrate to gases. Revesz and Böhlke [63] pointed out the possibility of methodological errors for some of the lower precipitation  $\delta^{18}\text{O}$  values observed using earlier methods, such as exchange with

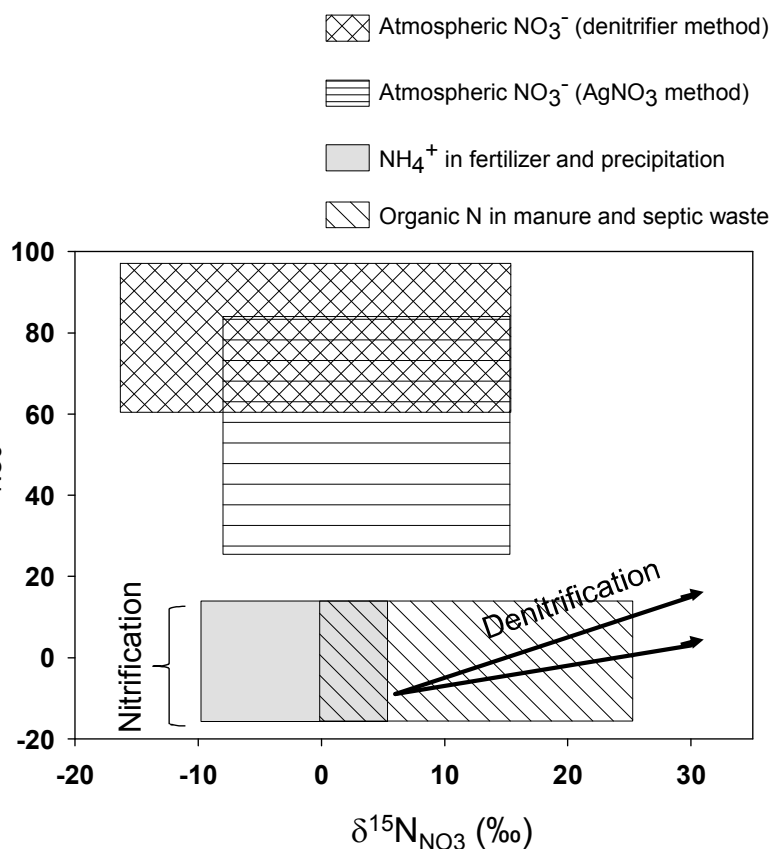

FIG. 2. Schematic diagrams of typical ranges of  $\delta^{15}\text{N}$  and  $\delta^{18}\text{O}$  values of nitrate derived or nitrified from various nitrogen sources (adapted from [59]). Nitrification of ammonium and/or organic-N in fertilizer, precipitation, and organic waste can produce a large range of  $\delta^{15}\text{N}$  values. The  $\text{NO}_3^-$  which originates from organic waste is generally higher in  $\delta^{15}\text{N}$ . The  $\delta^{18}\text{O}$  of  $\text{NO}_3^-$  in precipitation tends to be significantly higher than that produced by nitrification. Atmospheric  $\delta^{18}\text{O}$  of  $\text{NO}_3^-$  data are divided into the ranges observed for samples analysed using denitrifier and  $\text{AgNO}_3$  (non-denitrifier) methods. The two arrows indicate typical expected slopes for data resulting from denitrification of nitrate with initial  $\delta^{15}\text{N} = +6\text{‰}$  and  $\delta^{18}\text{O} = -9\text{‰}$ . The typical ranges of  $\delta^{18}\text{O}$  of  $\text{NO}_3^-$  values produced by nitrification of ammonium and organic matter are denoted by 'nitrification'.

O in a glass tube or contamination by other O-bearing materials in the silver oxide (e.g. organic compounds, sulfate, carbonate).

Based on the  $\delta^{18}\text{O}$  value, the  $\text{NO}_3^-$  supplied through precipitation can be distinguished from the  $\text{NO}_3^-$  produced via microbial activity in soils or added to soil as synthetic fertilizer, a distinction which cannot be made solely using  $\delta^{15}\text{N}$ . Denitrification increases both the  $\delta^{15}\text{N}$  and  $\delta^{18}\text{O}$  values of residual  $\text{NO}_3^-$ , while  $\text{NO}_3^-$  concentrations decrease. The  $\delta^{15}\text{N}$ – $\delta^{18}\text{O}$  diagram is thus for examining not only the origins of  $\text{NO}_3^-$ , but also the occurrence of processes involved in N transformations.

Several studies evaluated the contribution of atmospheric  $\text{NO}_3^-$  to stream  $\text{NO}_3^-$  in North America, using  $\delta^{18}\text{O}$  of  $\text{NO}_3^-$  [64–66]. These studies typically involved samples collected at intervals of several weeks to months, and discussed seasonal changes in the contribution of atmospheric  $\text{NO}_3^-$  to stream  $\text{NO}_3^-$ . Ohte et al. [67] measured the  $\delta^{15}\text{N}$  and  $\delta^{18}\text{O}$  values of stream  $\text{NO}_3^-$  at a very high frequency using the denitrification method (Fig. 3). Fluctuations in the concentration and the  $\delta^{18}\text{O}$  value of  $\text{NO}_3^-$  in streams suggested that atmospheric  $\text{NO}_3^-$  made a large, direct contribution during the early snowmelt period in a forested watershed in the northeastern United

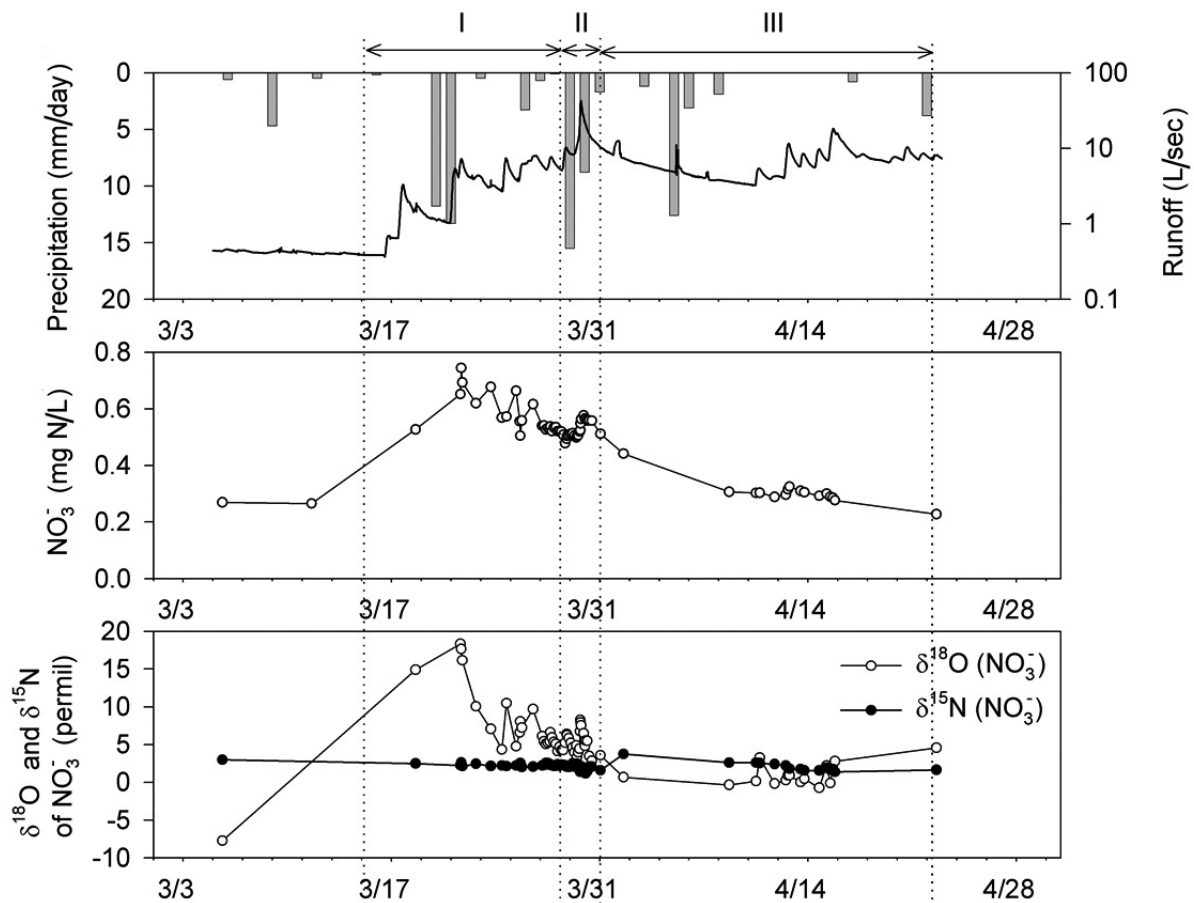

FIG. 3. Precipitation, runoff, snow water equivalent (SWE), nitrate concentration,  $\delta^{18}\text{O}$  and  $\delta^{15}\text{N}$  of nitrate during snowmelt 2003. Phase I took place 16 to 29 March, Phase II took place 29 to 31 March, and Phase III took place 1 to 22 April. Precipitation includes rain and snow that fell in this period (modified from Ref. [67]). The  $\delta^{18}\text{O}$  fluctuation of nitrate closely corresponded to that of the nitrate concentration, while the  $\delta^{15}\text{N}$  did not significantly change.

States due to highly concentrated  $\text{NO}_3^-$  stored in the winter snow pack. Elliott et al. [68] measured the  $\delta^{15}\text{N}$  and  $\delta^{18}\text{O}$  values of precipitation collected across the United States and showed clear geographical patterns of precipitation  $\text{NO}_3^-$  affected by  $\text{NO}_x$  sources, such as stationary fuel combustion at electric power plants and vehicular emissions.

### 2.2.1. Case study: Use of $\delta^{15}\text{N}$ and $\delta^{18}\text{O}$ values of nitrate for the evaluation of environmental 'health' of the Lake Biwa watershed

#### 2.2.1.1. Catchment scale application

We have been evaluating the 'environmental health' of rivers around Lake Biwa since 2003 using multiple isotope values such as  $\delta^{15}\text{N}$ ,  $\delta^{13}\text{C}$ ,  $\delta^{18}\text{O}$ ,  $\delta\text{D}$  and  $\delta^{34}\text{S}$  in water, dissolved constituents, organic matters and organisms [69]. For 32 rivers draining in the Lake Biwa basin, we have collected and analyzed isotope information to evaluate water quality (such as pollution status), nutrient conditions, and ecological status and to propose indices to be used for the assessment of the integrated 'health' of the river ecosystem. Here, we present some new findings and discuss our perspectives for future research direction.



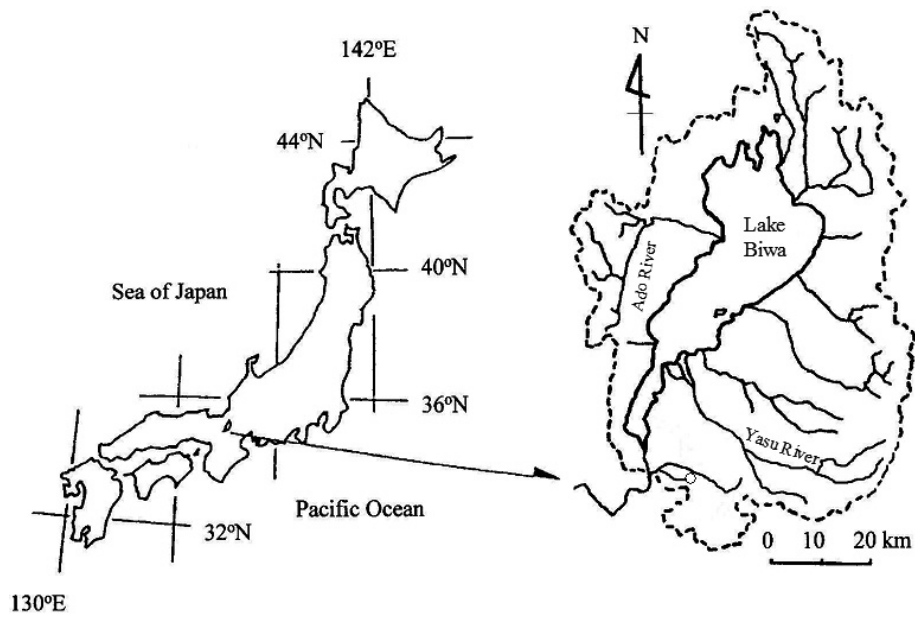

FIG. 4. Locations of Lake Biwa, Yasu River, and Ado River. ○ indicates the Kiryu Experimental Watershed, which is the forested headwater catchment where nitrate isotopes were monitored in soil water, groundwater, and stream water.

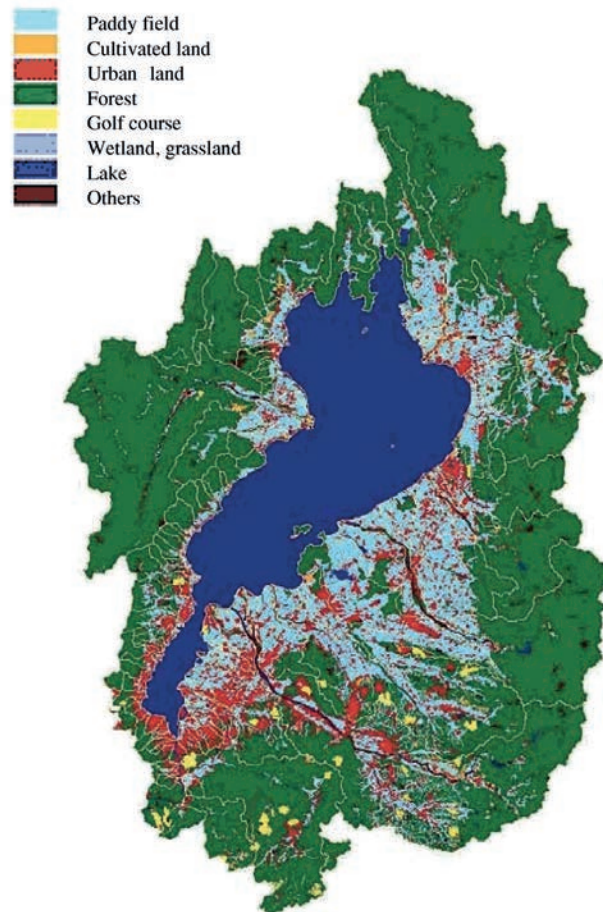

FIG. 5. Land use distributions of the Lake Biwa basin (modified from a map published in the web site of the Shiga prefecture, Japan [70]).

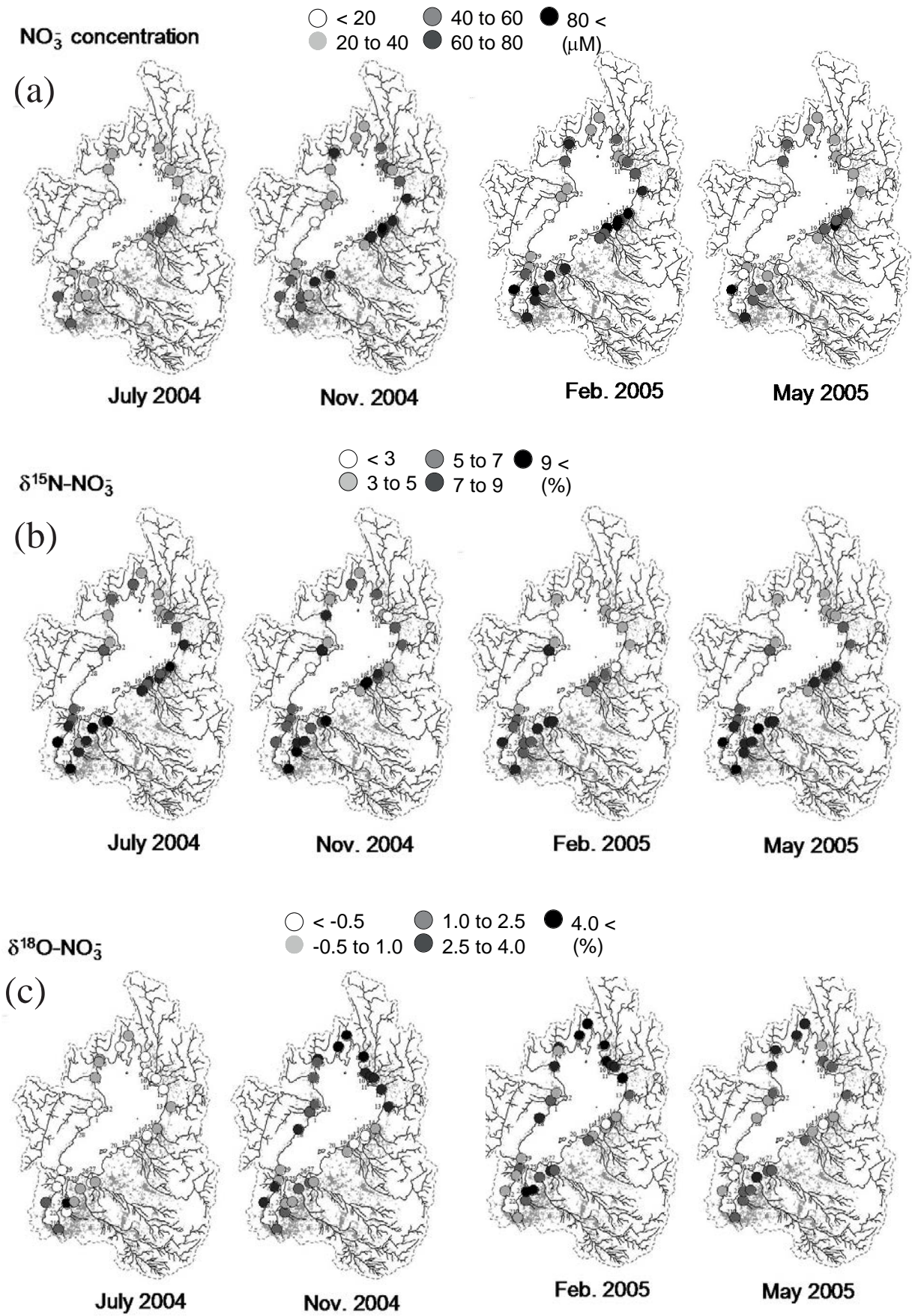

FIG. 6. (a) concentration of nitrate (b)  $\delta^{15}\text{N}$ , and (c)  $\delta^{18}\text{O}$  of nitrate in river waters sampled near river mouths of major Lake Biwa rivers. Grey dots indicate residential areas.



Lake Biwa is the largest freshwater lake in Japan (670 km<sup>2</sup>) with more than a hundred in-flowing rivers and a single outflow river (Fig. 4). Lake Biwa basin is located in the temperate climate region at latitudes from 34.5 to 35.5°N, and elevation ranges from 140 to 1370 m. Climatic and hydrological features are described in more detail by Suzuki and Fukushima [71]. In this lake basin, forests are found in the northern and western parts, agricultural land (mainly rice paddies) in the eastern part, and urban areas in the southern part (Fig. 5).

We determined NO<sub>3</sub><sup>-</sup> concentrations and δ<sup>15</sup>N and δ<sup>18</sup>O values of NO<sub>3</sub><sup>-</sup> in river water sampled near the mouths of the major rivers under base flow condition (Fig. 6a–c). The NO<sub>3</sub><sup>-</sup> concentrations and isotope values varied corresponding to spatial patterns of land use in this basin. The NO<sub>3</sub><sup>-</sup> concentrations were relatively high in the rivers flowing into the eastern and southern parts of Lake Biwa (Fig. 6a). This suggests that both agricultural fields (west, mostly paddy fields) and residential and urban areas (south) supply high loads of NO<sub>3</sub><sup>-</sup> to the rivers flowing into the lake. The δ<sup>15</sup>N values showed clearer spatial variations than NO<sub>3</sub><sup>-</sup> concentrations (Fig. 6b). The average δ<sup>15</sup>N values of NO<sub>3</sub><sup>-</sup> in rivers flowing through agricultural and residential areas (+6.2‰ for the eastern part and +8.0‰ for the southern parts) were significantly higher than those in the northern part (+3.9‰) covered mostly by forests. This suggests that the N isotope composition can be used to identify the effect of NO<sub>3</sub><sup>-</sup> input originating from human sewage. Agricultural waste did not include animal waste significantly, because the agricultural area was mostly occupied by paddy fields. On the other hand, temporal variations were more pronounced in changes in NO<sub>3</sub><sup>-</sup> concentrations (high concentrations in November and February and low concentrations in May and July) than in isotope values.

In contrast, the δ<sup>18</sup>O values of NO<sub>3</sub><sup>-</sup> were higher in the northern rivers flowing from forested catchments and lower in the southeastern part where paddy fields are predominant (Fig. 6c). Multiple factors might affect the spatial variations of δ<sup>18</sup>O values of NO<sub>3</sub><sup>-</sup>. One possible explanation for the spatial pattern is that in forested areas, antecedent rainwater NO<sub>3</sub><sup>-</sup> with higher δ<sup>18</sup>O values, which comes from natural water reservoirs in soils and groundwater, may contribute preferentially to drainage water even in base flow periods. In agricultural land (especially in paddy fields) and residential areas, well organized artificial drainage systems drain promptly to rivers during storm events if water storage for irrigation is not necessary. As a result, the effect of antecedent rainwater is weakened during the base flow period, resulting in lower values of δ<sup>18</sup>O of NO<sub>3</sub><sup>-</sup> in stream water.

The values of δ<sup>18</sup>O value of NO<sub>3</sub><sup>-</sup> also showed temporal variations, which include lower δ<sup>18</sup>O values observed in July 2004. In that month, precipitation and discharge rates were substan-

TABLE 1. SAMPLING DATE AND SOME HYDROLOGIC CONDITIONS OF THE 32 RIVERS SURVEY IN THE LAKE BIWA BASIN

Sampling	Last storm runoff	Water level at the Amano River <sup>a</sup> gauging station (m)
July 25–29, 2004	1 month before	0.34 ± 0.01
November 4–8, 2004	1/2 month before	0.64 ± 0.02
February 7–17, 2005	1 month before	0.65 ± 0.02
May 16–17, 2005	1/3 month before	0.51 ± 0.02

<sup>a</sup> Amano River is a typical northeast side river ('13' in Fig. 6).

tially lower than in the preceding months (Table 1), creating a drought condition in the entire Lake Biwa basin. Under this dry condition in the forested catchments, infiltration to soils may be hampered and subsurface runoff containing antecedent rainwater with atmospherically derived  $\text{NO}_3^-$  (higher  $\delta^{18}\text{O}$  values) might not have efficiently entered into drainages, decreasing  $\delta^{18}\text{O}$  values of nitrate even in drainage waters from forested areas.

To examine the influences of wastewater N inputs on  $\text{NO}_3^-$  concentrations and the  $\delta^{15}\text{N}$  and  $\delta^{18}\text{O}$  values of  $\text{NO}_3^-$  in more detail, we compared those values between the Yasu River (with high anthropogenic N inputs) and the Ado River (with low anthropogenic N inputs) in the Lake Biwa watershed (Fig. 7). In the Yasu River ('25' in Fig. 6) basin, agricultural fields, mainly consisting of paddies, and residential areas are predominant in the middle to downstream parts, whereas the upstream area is steep and covered with forests. In the Ado River ('2' in Fig. 6) basin, forested lands are predominant. In the Ado River, the  $\text{NO}_3^-$  concentration and  $\delta^{15}\text{N}$  values are slightly higher downstream than in the upper stream. In contrast, in the Yasu River, both  $\text{NO}_3^-$  concentrations and  $\delta^{15}\text{N}$  values are elevated in drainage water from the middle part of the river, suggesting marked influences of human wastewater inflow from populated areas, including agricultural fields and residential areas. The  $\delta^{18}\text{O}$  values of  $\text{NO}_3^-$  in the Yasu River

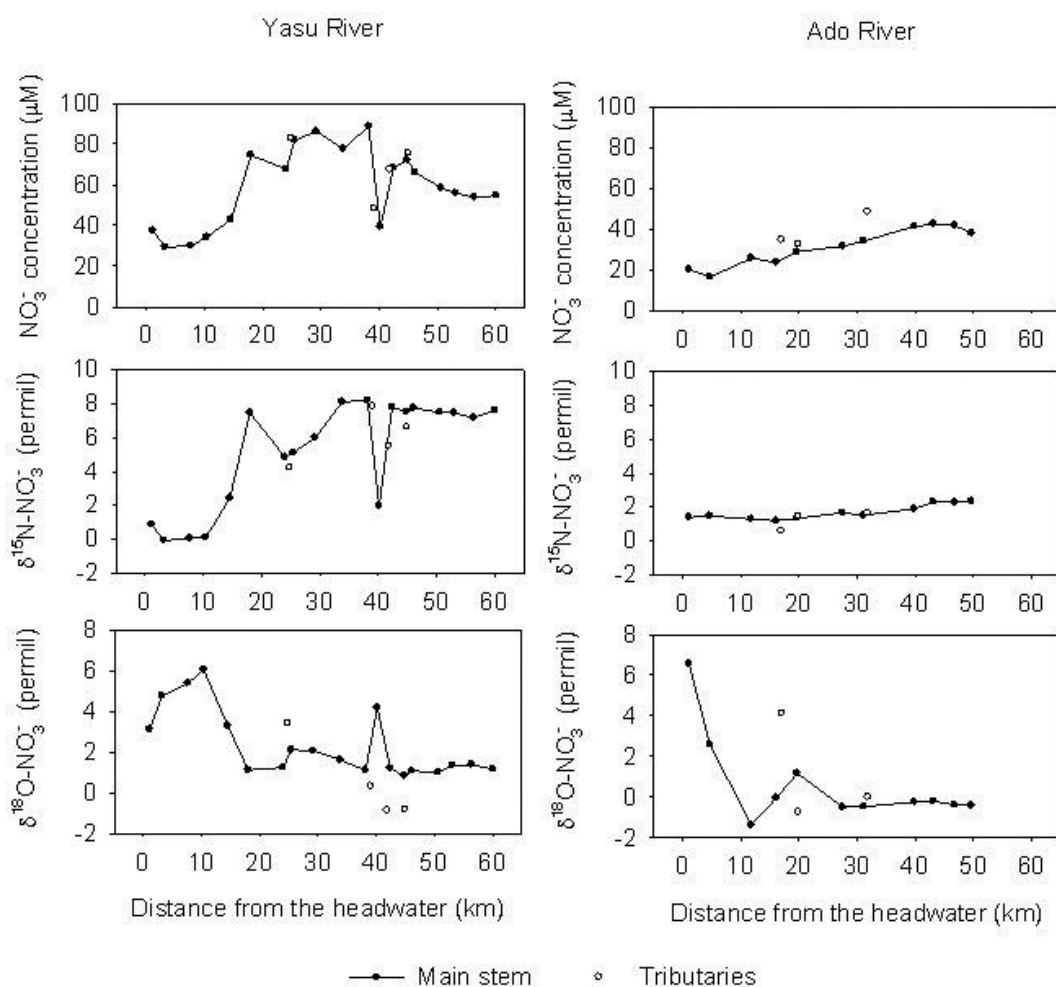

FIG. 7. Comparison of changes in the concentration,  $\delta^{15}\text{N}$ , and  $\delta^{18}\text{O}$  of nitrate between rivers with (Yasu River) and without human waste nitrogen inputs (Ado River). The Yasu River basin contains an agricultural region that consists mainly of paddies and residential areas in the mid to downstream parts, while the forest dominates the Ado River basin [72].

decrease from upstream (+ 4 to + 7‰) to downstream (+1 to +2‰). Higher  $\delta^{18}\text{O}$  values in the upstream area of the Yasu River basin may be due to the larger contribution of atmospheric  $\text{NO}_3^-$  stored in the forested area upstream, compared to downstream where human waste N enters from agricultural and urbanized areas. In the Ado River, although no significant changes are seen in the concentration and  $\delta^{15}\text{N}$  of  $\text{NO}_3^-$ , the  $\delta^{18}\text{O}$  values decrease markedly from the headwater to the middle part of the basin (Fig. 7). While the upper part of the basin is steep, the middle to lower parts are topographically gentle, allowing for a greater contribution of groundwater to drainage water in the middle to lower parts of the basin. In groundwater, the proportion of atmosphere derived  $\text{NO}_3^-$  (high  $\delta^{18}\text{O}$ ) is considered to decrease compared to  $\text{NO}_3^-$  generated by soil microbes via nitrification. Moreover, the streambed gradient is gentle in the middle to lower parts of the Ado River. This might provide favorable conditions for  $\text{NO}_3^-$  uptake and/or exchange by benthic microbes and algae in hyporheic zones in the streambed, leading to decreasing  $\delta^{18}\text{O}$  values of  $\text{NO}_3^-$ . These speculations are possible explanations that can be applied to the Yasu River process. The spatial pattern of  $\delta^{18}\text{O}$  in the Yasu River could be also due to the influence of topography, considering the gentle topographic gradient from the middle to the lower parts of the Yasu River. Thus, compared to  $\delta^{15}\text{N}$  of  $\text{NO}_3^-$  as above, changes in  $\delta^{18}\text{O}$  of  $\text{NO}_3^-$  could be attributed to differences in hydrological processes between the headwater versus the middle to lower reaches of the river. Further investigations evidencing these interpretations are needed.

#### 2.2.1.2. *Application of dual isotope measurements of $\text{NO}_3^-$ in the evaluation of small catchment processes*

The isotopic composition of  $\text{NO}_3^-$ ,  $\delta^{15}\text{N}$  and  $\delta^{18}\text{O}$ , can vary considerably in hydrological and biogeochemical processes in forested ecosystems. We examined the  $\delta^{15}\text{N}$  and  $\delta^{18}\text{O}$  values of  $\text{NO}_3^-$  in precipitation, throughfall, soil, and stream waters and groundwater in a forested headwater catchment in Lake Biwa basin (Fig. 8). The  $\delta^{15}\text{N}$  values were higher in groundwater and lower in soil water. In this aquifer, Koba et al. [73] reported that  $\delta^{15}\text{N}$  values of  $\text{NO}_3^-$  increased with decreasing  $\text{NO}_3^-$  concentration, which suggests that the higher  $\delta^{15}\text{N}$  observed in groundwater was probably due to denitrification.

The  $\delta^{18}\text{O}$  of  $\text{NO}_3^-$  in rainwater varies over a wide range and was relatively high (+40 to +85‰). In comparison, the  $\delta^{18}\text{O}$  of  $\text{NO}_3^-$  of soil and groundwater was remarkably low (−5 to +15‰). The majority of  $\text{NO}_3^-$  in soil water and groundwater was considered to be produced by nitrifying bacteria in soil at this site [74]. This low range of  $\delta^{18}\text{O}$  values of  $\text{NO}_3^-$  occurred because the oxygen atoms used in the nitrification process were obtained from pore water (approximately −8‰; [75]) and atmospheric oxygen (approximately +23‰; [76]). Some laboratory studies reported that two of the oxygen atoms in  $\text{NO}_3^-$  derive from  $\text{H}_2\text{O}$  and one derives from  $\text{O}_2$  [77, 78]. Sigman et al. [52] also showed that 5/6 of the oxygen atoms in  $\text{NO}_3^-$  are obtained from water. These findings suggest that the  $\delta^{18}\text{O}$  value of  $\text{NO}_3^-$  produced by microbial nitrification in forest soils should range from −3 to +3‰, which corresponds with the values compiled by Kendall et al. [59]. Fig. 8 suggests that  $\text{NO}_3^-$  supplied by precipitation was used by microbes and/or plants in relatively shallow soil horizons and that  $\text{NO}_3^-$  in groundwater, losing the signature of  $\text{NO}_3^-$  from precipitation, may be produced mostly by nitrification.

Our study suggests that the  $\delta^{18}\text{O}$  value could provide important information for identifying the sources of  $\text{NO}_3^-$  from small headwaters to large river systems. The  $\delta^{18}\text{O}$  values of  $\text{NO}_3^-$  differ between atmospherically derived  $\text{NO}_3^-$ , subsurface drained water and groundwater, which enables the evaluation of relative contributions of sources when denitrification and other biogeochemical alterations to isotope compositions are assumed to be small.

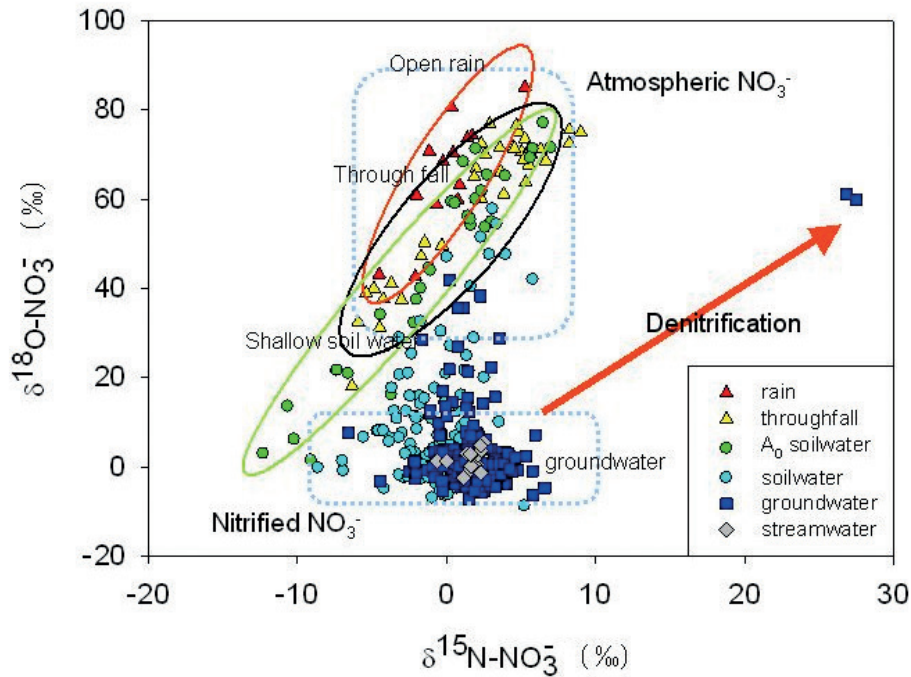

FIG. 8.  $\delta^{15}\text{N}$  and  $\delta^{18}\text{O}$  of dissolved  $\text{NO}_3^-$  in various hydrological processes in the forested headwater catchment of the Lake Biwa basin [79].

### 2.3. Future perspectives on the application of isotope measurements of nitrate and related compounds

Conventional monitoring approaches without isotope techniques have been useful for diagnosing discharges, water quality, and biotic communities in rivers (e.g. [80, 81]). However, these approaches have provided limited clues about the sources of water and materials and geochemical and ecosystem processes that control material cycling and affect food webs. The use of multiple stable isotope ratios of water, nutrients, and organisms can add more insightful information, which enable integrated diagnostic assessment in river systems in a timely, cost effective fashion. An important advantage of the multiple stable isotope approach is the integration of robust principles and methodologies that have already been developed in individual disciplines, including watershed hydrology, geochemistry, and community ecology. In addition, recent developments in mass spectrometry have made high throughput measurements possible at a much lower cost. Intensive monitoring using multiple environmental isotopes has become a practical option for diagnosing watershed environments.

Careful monitoring coordination using multiple stable isotope ratios in a given watershed can provide comprehensive information on: (a) the sources and flow paths of water and nutrients, especially N compounds; (b) records of various metabolic reactions in ecosystems (such as the production/respiration ratio in aquatic ecosystems from  $\delta^{18}\text{O}$  values of water, as well as rates of nitrification and denitrification from  $\delta^{15}\text{N}$  and  $\delta^{18}\text{O}$  of nitrogen compounds); and (c) the energy base and food web structure of aquatic communities, which differs among watershed types and scales. These new data should supplement conventional approaches and aid in the interpretation of data produced by conventional approaches to evaluate ongoing and potential anthropogenic and natural changes in complex watershed systems.

Further, as discussed in other sections in this guidebook, food web analysis in river systems is an indispensable part of an integrated assessment of ecosystem health, together with the evaluation of nutrient dynamics using isotope tracing. For instance, Cabana and Rasmussen [82] developed a conceptual model to express the spatial distribution of  $\delta^{15}\text{N}$  of various aquatic organisms at different levels in a food web in rivers and lakes as a function of population density, which is a proxy of the strength of anthropogenic N inputs. In addition, results of the project described in this section suggest that the  $\delta^{15}\text{N}$  values of sediments and fish are excellent indicators of the perturbation of the N cycle and food webs of river communities [83]. To conduct a successful integrated evaluation of river ecosystem health, protocols for the use of multiple isotopes will be needed both to trace nutrient cycles and to examine food web structures.

## REFERENCES

- [1] GALLOWAY, J.N., SCHLESINGER, W.H., LEVY, H., II, MICHAELS, A., SCHNOOR, J.L., Nitrogen fixation: Anthropogenic enhancement- environmental response, *Glob. Biogeochem. Cycles* **9** (1995) 227–234.
- [2] GALLOWAY, J.N., COWLING, E.B., Reactive nitrogen and the World: 200 Years of Change, *AMBIO* **31** (2002) 64–71.
- [3] REYNOLDS, C.S., DESCY, J.-P., The production, biomass and structure of phytoplankton in large rivers, *Archiv für Hydrobiologie, Supplement-Band* **113** (1996) 161–187.
- [4] ANDERSON, D.M., GLIBERT, P.M., BURKHOLDER, J.M., Harmful Algal Blooms and Eutrophication: Nutrient Sources, Composition, and Consequences, *Estuaries* **25** 4 (2002) 704–726.
- [5] RABALAIS, N.N., Nitrogen in Aquatic Ecosystems, *AMBIO* **31** 2 (2002) 102–112.
- [6] KRATZER, C.R., et al., Sources and transport of nutrients, organic carbon and chlorophyll-a in the San Joaquin River upstream of Vernalis, California during Summer and Fall, 2000 and 2001 (2004) 113.
- [7] TAKEUCHI, M., ITAHASHI, S., SAITO, M., A water quality analysis system to evaluate the impact of agricultural activities on N outflow in river basins in Japan, *Science in China, Series C: Life Sciences* **48** (2005) 100–109.
- [8] OKI, K., YASUOKA, Y., Mapping the potential annual total nitrogen load in the river basins of Japan with remotely sensed imagery, *Remote Sens. Environ.* **112** 6 (2008) 3091–3098.
- [9] ALLAN, J.D., *Stream Ecology: Structure and function of running waters*, Kluwer Academic, London (1995) 400.
- [10] KALFF, J., *Limnology*, Prentice-Hall, NJ (2001).
- [11] LINDSTRÖM, G., ROSBERG, J., ARHEIMER, B., Parameter Precision in the HBV-NP Model and Impacts on Nitrogen Scenario Simulations in the Rönneå River, Southern Sweden, *AMBIO* **34** 7 (2005) 533–537.
- [12] OHTE, N., et al., Sources and transport of algae and nutrients in a Californian river in a semi-arid climate, *Freshw. Biol.* **52** (2007) 2476–2493.



- [13] KENDALL, C., “Tracing nitrogen sources and cycling in catchments”, Isotope tracers in catchment hydrology (KENDALL, C., MCDONNELL, J.J., Eds), Elsevier, New York (1998) 519–576.
- [14] HOERING, T., The isotopic composition of the ammonia and nitrate ion in rain, *Geochim. Cosmochim. Acta* **12** (1957) 97–102.
- [15] BENSON, B.B., PARKER, P.D.M., Nitrogen/argon and nitrogen isotope ratios in aerobic sea water, *Deep Sea Res.* **7** (1961) 237–253.
- [16] KOHL, D.H., SHEARER, G.B., COMMONER, B., Fertilizer nitrogen: contribution to nitrate in surface water in a corn belt watershed, *Science* **174** (1971) 1331–1334.
- [17] HEATON, T.H.E., Isotopic studies of nitrogen pollution in the hydrosphere and atmosphere: A review, *Chem. Geol.* **59** (1986) 87–102.
- [18] ARAVENA, R., EVANS, M.L., CHERRY, J.A., Stable isotopes of oxygen and nitrogen in source identification of nitrate from septic systems, *Ground Water* **31** (1993) 180–186.
- [19] LAJTHA, K., MICHENER, R.H., *Stable Isotopes in Ecology and Environmental Science (Methods in Ecology)*, Blackwell Scientific Inc, London (1994) 336.
- [20] KENDALL, C., MCDONNELL, J.J., *Isotope Tracers in Catchment Hydrology*, Elsevier Science Ltd, Amsterdam (1998) 870.
- [21] MACKO, S.A., OSTROM, N.E., “Pollution studies using stable isotopes”, *Stable Isotopes in Ecology and Environmental studies* (LAJTHA, K., MICHENER, R.H., Eds), Blackwell Scientific Publications, Oxford (1994) 45–62.
- [22] MCCLELLAND, J.W., VALIELA, I., MICHENER, R.H., Nitrogen-stable isotope signatures in estuarine food webs: A record of increasing urbanization in coastal watersheds, *Limnol. Oceanogr.* **42** (1997) 930–937.
- [23] MCKINNEY, R.A., LAKE, J.L., ALLEN, M., RYBA, S., Spatial variability in mussels used to assess base level nitrogen isotope ratio in freshwater ecosystems, *Hydrobiologia* **412** (1999) 17–24.
- [24] VALIELA, I., GEIST, M., MCCLELLAND, J., TOMASKY, G., Nitrogen loading from watersheds to estuaries: Verification of the Waquoit Bay nitrogen loading model, *Biogeochemistry* **49** (2000) 277–293.
- [25] LAKE, J.L., et al., Stable nitrogen isotopes as indicators of anthropogenic activities in small freshwater systems, *Can. J. Fish. Aquat. Sci.* **58** (2001) 870–878.
- [26] MAYER, B., et al., Sources of nitrate in rivers draining sixteen watersheds in the northeastern U.S.: Isotopic constraints, *Biogeochemistry* **57/58** 1 (2002) 171–197.
- [27] VALIELA, I., BOWEN, J.L., Nitrogen sources to watersheds and estuaries: role of land cover mosaics and losses within watersheds, *Environ. Pollu.* **118** 2 (2002) 239–248.
- [28] CARMICHAEL, R.H., ANNETT, B., VALIELA, I., Nitrogen loading to Pleasant Bay, Cape Cod: application of models and stable isotopes to detect incipient nutrient enrichment of estuaries, *Mar. Pollut. Bull.* **48** (2004) 137–143.

- [29] FRY, B., GACE, A., MCCLELLAND, J.W., Chemical indicators of anthropogenic nitrogen loading in four Pacific estuaries, *Pacific Sci.* **57** (2003) 77–101.
- [30] JONES, R.I., KING, L., DENT, M.M., MABERLY, S.C., GIBSON, C.E., Nitrogen stable isotope ratios in surface sediments, epilithon and macrophytes from upland lakes with differing nutrient status, *Freshw. Biol.* **49** (2004) 382–391.
- [31] LEHMANN, M.F., BERNASCONI, S.M., BARBIERI, A., SIMONA, M., MCKENZIE, J.A., Interannual variation of the isotopic composition of sedimenting organic carbon and nitrogen in Lake Lugano: a long-term sediment trap study, *Limnol. Oceanogr.* **49** (2004) 839–849.
- [32] CLINE, J.D., KAPLAN, I.R., Isotopic fractionation of dissolved nitrate during denitrification in the eastern tropical north pacific ocean, *Mar. Chem.* **3** 4 (1975) 271–299.
- [33] BROOKS, P.D., STARK, J.M., MCINTEER, B.B., PRESTON, T., Diffusion Method To Prepare Soil Extracts For Automated Nitrogen-15 Analysis, *Soil. Sci. Soc. Am. J.* **53** 6 (1989) 1707–1711.
- [34] SIGMAN, D.M., et al., Natural abundance-level measurement of the nitrogen isotopic composition of oceanic nitrate: an adaptation of the ammonia diffusion method, *Mar. Chem.* **57** 3–4 (1997) 227–242.
- [35] SILVA, S.R., et al., A new method for collection of nitrate from fresh water and the analysis of nitrogen and oxygen isotope ratios, *J. Hydrol.* **228** (2000) 22–36.
- [36] AMBERGER, A., SCHMIDT, H.L., Natürliche Isotopengehalte von nitrat als indikatoren für dessen herkunft, *Geochim. Cosmochim. Acta* **51** (1987) 2699–2705.
- [37] ROCK, L., MAYER, B., Isotopic Assessment of Sources of Surface Water Nitrate within the Oldman River Basin, Southern Alberta, Canada, *Water Air Soil Poll.: Focus* **4** 2 (2004) 545–562.
- [38] PIATEK, K.B., MITCHELL, M.J., SILVA, S.R., KENDALL, C., Sources of Nitrate in Snowmelt Discharge: Evidence From Water Chemistry and Stable Isotopes of Nitrate, *Water Air Soil Poll.* **165** 1 (2005) 13–35.
- [39] CAMPBELL, J.L., MITCHELL, M.J., MAYER, B., Isotopic assessment of NO<sub>3</sub><sup>-</sup> and SO<sub>4</sub><sup>2-</sup> mobility during winter in two adjacent watersheds in the Adirondack Mountains, New York, *J. Geophys. Res.* **111** (2006) G04007, doi:10.1029/2006JG000208.
- [40] ACCOE, F., BERGLUND, M., GEYPENS, B., TAYLOR, P., Methods to reduce interference effects in thermal conversion elemental analyser/continuous flow isotope ratio mass spectrometry  $\delta^{18}\text{O}$  measurements of nitrogen-containing compound, *Rapid Comm. Mass Spectr.* **22** 14 (2008) 2280–2286.
- [41] CHANG, C.C.Y., et al., A method for nitrate collection for d<sup>15</sup>N and d<sup>18</sup>O analysis from waters with low nitrate concentrations, *Can. J. Fish. Aquat. Sci.* **56** (1999) 1856–1864.
- [42] PANNO, S.V., HACKLEY, K.C., HWANG, H.H., KELLY, W.R., Determination of the sources of nitrate contamination in karst springs using isotopic and chemical indicators, *Chem. Geol.* **179** 1–4 (2001) 113–128.
- [43] SCHIFF, S.L., et al., Two adjacent forested catchments: Dramatically different NO<sub>3</sub><sup>-</sup> export. *Water Resour. Res.* **38** (2002) doi:10.1029/2000WR000170.



- [44] SIGMAN, D.M., et al., A bacterial method for the nitrogen isotopic analysis of nitrate in seawater and freshwater, *Anal. Chem.* **73** (2001) 4145–4153.
- [45] CASCIOTTI, K.L., SIGMAN, D.M., HASTINGS, M.G., BÖHLKE, J.K., HILKERT, A., Measurement of the oxygen isotopic composition of nitrate in seawater and freshwater using the denitrifier method, *Anal. Chem.* **74** (2002) 4905–4912.
- [46] YOSHIMIZU, C., OHTE, N., “Automation and speed-up, Case of nitrate isotope analysis”, *Stable isotopes in Environmental Assessment of Watersheds – Progress Towards an Integrated Approach* (NAGATA, T., MIYAJIMA, T., Eds), Kyoto: Kyoto University Press (2007) 376–387 (in Japanese).
- [47] BÖHLKE, J.K., MROCKOWSKI, S.J., COPLEN, T.B., Oxygen isotopes in nitrate: new reference materials for  $^{18}\text{O}$ : $^{17}\text{O}$ : $^{16}\text{O}$  measurements and observations on nitrate-water equilibration, *Rapid Commun. Mass Spectrom.* **17** (2003) 1835–1846, doi: 10.1002/rcm.1123.
- [48] MCILVIN, M.R., ALTABET, M.A., Chemical Conversion of Nitrate and Nitrite to Nitrous Oxide for Nitrogen and Oxygen Isotopic Analysis in Freshwater and Seawater, *Anal. Chem.* **77** 17 (2005) 5589–5595.
- [49] KOMATSU, D.D., OHKUBO, S., ISHIMURA, T., NAKAGAWA, F., TSUNOGAI, U., Determination of triple oxygen isotopic compositions of nitrate by using continuous-flow isotope ratio MS, *Eos Trans, AGU* **87** 52 Fall Meet. Suppl. (2006) Abstract H13C–1409.
- [50] TSUNOGAI, U., et al., Sensitive determinations of stable nitrogen isotopic composition of organic nitrogen through chemical conversion into  $\text{N}_2\text{O}$ , *Rapid Commun. Mass Spectrom.* **22** 3 (2008) 345–354.
- [51] HASTINGS, M.G., STEIG, E.J., SIGMAN, D.M., Seasonal variations in N and O isotopes of nitrate in snow at Summit, Greenland: Implications for the study of nitrate in snow and ice cores, *J. Geophys. Res.* **109** (2004) D20306, doi:10.1029/2004JD004991.
- [52] SIGMAN, D.M., et al., Coupled nitrogen and oxygen isotope measurements of nitrate along the eastern North Pacific margin, *Glob. Biogeochem. Cycles* **19** (2005) GB402, doi:10.1029/2005GB002458.
- [53] WANKEL, S.D., KENDALL, C., FRANCIS, C.A., PAYTAN, A., Nitrogen sources and cycling in the San Francisco Bay Estuary: A nitrate dual isotope approach, *Limnol. Oceanogr.* **51** 4 (2006) 1654–1664.
- [54] CHANG, C.C.Y., et al., “Preparation and analysis of nitrogen-bearing compounds in water for stable isotope ratio measurement”, *Handbook of stable isotope analytical techniques* (de Groot P.A., Ed.), Elsevier, Amsterdam (2004) 305–347.
- [55] HASTINGS, M.G., SIGMAN, D.M., LIPSCHULTZ, F., Isotopic evidence for source changes of nitrate in rain at Bermuda, *J. Geophys. Res.* **108** D24 (2003) 4790.
- [56] COPLEN, T.B., BÖHLKE, J.K., CASCIOTTI, K.L., Using dual-bacterial denitrification to improve  $\delta^{15}\text{N}$  determinations of nitrates containing mass-independent  $^{17}\text{O}$ , *Rapid Commun. Mass Spectrom.* **18** 3 (2004) 245–250.

- [57] GRANGER, J., SIGMAN, D.M., PROKOPENKO, M.G., LEHMANN, M.F., TORTELL, P.D., A method for nitrite removal in nitrate N and O isotope analyses, *Limnol. Oceanogr. Methods* **4** (2006) 205–212.
- [58] VOERKELIUS, S., Isotopendiskriminierungen bei der Nitrifikation und Denitrifikation: Grundlagen und Anwendungen der Herkunfts-Zuordnung von Nitrat und Distickstoffmonoxid, Ph.D. dissertation, Tech. Univ. München (1990) 119.
- [59] KENDALL, C., ELLIOTT, E.M., WANKEL, S.D., “Tracing anthropogenic inputs of nitrogen to ecosystems”, *Stable Isotopes in Ecology and Environmental Science* (MICHENER, R.H., LAJTHA, K., Eds), Blackwell Publishing, Oxford (2007) 375–449.
- [60] FREYER, H.D., Seasonal variation of  $^{15}\text{N}/^{14}\text{N}$  ratios in atmospheric nitrate species, *Tellus* **B43** 1 (1991) 30–44.
- [61] WAHLEN, M., YOSHINARI, T., Oxygen isotope ratios in  $\text{N}_2\text{O}$  from different environments, *Nature* **313** 6005 (1985) 780–782.
- [62] KRANKOWSKY, D., et al., Measurement of heavy isotope enrichment in tropospheric ozone, *Geophys. Res. Lett.* **22** (1995) 1713–1716.
- [63] REVESZ, K., BÖHLKE, J. K., Comparison of  $\delta^{18}\text{O}$  Measurements in Nitrate by Different Combustion Techniques, *Anal. Chem.* **74** 20 (2002) 5410–5413.
- [64] WILLIARD, K.W.J., DEWALLE, D.R., EDWARDS, P.J., SHARPE, W.E.,  $^{18}\text{O}$  isotopic separation of stream nitrate sources in mid-Appalachian forested watersheds, *J. Hydrol.* **252** 1–4 (2001) 174–188.
- [65] BURNS, D.A., KENDALL, C., Analysis of  $^{15}\text{N}$  and  $^{18}\text{O}$  to differentiate  $\text{NO}_3^-$  sources in runoff at two watersheds in the Catskill Mountains of New York, *Water Resour. Res.* **38** 5 (2002) 1051, doi:10.1029/2001WR000292.
- [66] CAMPBELL, D.H., KENDALL, C., CHANG, C.C.Y., SILVA, S.R., TONNESSEN, K.A., Pathways for nitrate release from an alpine watershed: Determination using  $\delta^{15}\text{N}$  and  $\delta^{18}\text{O}$ , *Water Resour. Res.* **38** 5 (2002) 1052, doi:10.1029/2001WR000294.
- [67] OHTE, N., et al., Tracing sources of nitrate in snowmelt runoff using a high-resolution isotopic technique, *Geophys. Res. Lett.* **31** (2004) L21506, doi:10.1029/2004GL020908.
- [68] ELLIOTT, E.M., et al., Nitrogen Isotopes as Indicators of  $\text{NO}_x$  Source Contributions to Atmospheric Nitrate Deposition Across the Midwestern and Northeastern United States, *Environ. Sci. Technol.* **41** 22 (2007) 7661–7667.
- [69] NAGATA, T., MIYAJIMA, T., *Stable isotopes in Environmental Assessment of Watersheds – Progress Towards an Integrated Approach*, Kyoto University Press, Kyoto (2008) 476 (in Japanese).
- [70] OHTE, N., I. TAYASU, A. KOHZU, C. YOSHIMIZU, K. I. OSAKA, A. MAKABE, K. KOBAYASHI, N. YOSHIDA, AND T. NAGATA. 2010. Spatial distribution of nitrate sources of rivers in the Lake Biwa watershed, Japan: Controlling factors revealed by nitrogen and oxygen isotope values. *Water Resour. Res.* 46:W07505. DOI: 10.1029/2009WR007871 (2010).

- [71] SUZUKI, M., FUKUSHIMA, Y., Estimates of Evapotranspiration from the Land Surface of Shiga Prefecture Using a Digitalized Square-Grid Map Database, *Lake Biwa Study Monographs* **2** (1985) 1–55.
- [72] OHTE, N., et al., Spatial distribution of nitrate sources of rivers in the Lake Biwa watershed, Japan: Controlling factors revealed by nitrogen and oxygen isotope values, *Water Resour. Res.* **46** W07505 (2010) doi:10.1029/2009WR007871.
- [73] KOBAYASHI, K., TOKUCHI, N., WADA, E., NAKAJIMA, T., IWATSUBO, G., Intermittent denitrification: The application of a  $^{15}\text{N}$  natural abundance method to a forested ecosystem, *Geochim. Cosmochim. Acta* **61** 23 (1997) 5043–5050.
- [74] HOBARA, S., et al., Mechanism of nitrate loss from a forested catchment following a small-scale natural disturbance, *Can. J. Forest Res.* **31** (2001) 1326–1335
- [75] KABEYA, N., KATSUYAMA, M., KAWASAKI, M., OHTE N., SUGIMOTO, A., Estimation of mean residence times of subsurface waters using seasonal variation in deuterium excess in a small headwater catchment in Japan, *Hydrol. Process.* **21** (2007) 308–322.
- [76] KROOPNICK P.M., CRAIG H., Atmospheric oxygen: Isotopic composition and solubility fractionation, *Science* **175** (1972) 54–55.
- [77] ANDERSON, K.K., HOOPER, A.B.,  $\text{O}_2$  and  $\text{H}_2\text{O}$  and each the source of one O in  $\text{NO}_2$  produced from  $\text{NH}_3$  by Nitrosomonas:  $^{15}\text{N}$  evidence, *FEBS Lett.* **164** (1983) 236–240.
- [78] KUMAR, S., NICHOLAS, D.J.D., WILLIAMS, E.H., Definitive  $^{15}\text{N}$  NMR evidence that water serves as a source of ‘O’ during nitrite oxidation by *Nitrobacter agilis*, *FEBS Lett.* **152** (1983) 71–74.
- [79] OSAKA, K., et al., 2009. Hydrological influences on spatiotemporal variations of  $\delta^{15}\text{N}$ ,  $\delta^{18}\text{O}$  of nitrate in a forested headwater catchment in central Japan: Denitrification plays a critical role in groundwater bodies, *J. Geophys. Res.* **115** (2010) G02021.
- [80] WETZEL, R.G., *Limnology*, Saunders, Philadelphia (1975).
- [81] HAUER, R., LAMBERTI, G.A., *Methods in Stream Ecology*, Second Edition, Academic Press, New York (2006) 896.
- [82] CABANA, G., RASMUSSEN, J., “Comparison of aquatic food chains using nitrogen isotopes”, *Proc. Nation. Acad. Sci. USA* **93** 20 (1996) 10844–10847.
- [83] KOHZU, A., et al., Nitrogen-stable isotopic signatures of basal food items, primary consumers and omnivores in rivers with different levels of human impact, *Ecol. Res.* **24** 1 (2009) 127–136, doi: 10.1007/s11284-008-0489-x.



# USING WHOLE STREAM $\delta^{15}\text{N}$ ADDITIONS TO UNDERSTAND THE EFFECTS OF LAND USE CHANGE ON STREAM FUNCTION

L.A. DEEGAN<sup>a</sup>, C. NEILL<sup>a</sup>, R.L. VICTORIA<sup>b</sup>, A.V. KRUSCHE<sup>b</sup>,  
M.V.R. BALLESTER<sup>b</sup>, S. THOMAS<sup>a</sup>, C. HAUPERT<sup>a</sup>

<sup>a</sup> Marine Biological Laboratory,  
Woods Hole, MA,  
USA

<sup>b</sup> Centro de Energia Nuclear na Agricultura,  
Universidade de São Paulo,  
São Paulo, Brasil.

## Abstract

In this paper we introduce an emerging new technique; the use of  $\delta^{15}\text{N}$  stable isotope tracers to understand both short term and long term alterations in stream ecosystem nitrogen biogeochemistry and food web dynamics. The use of  $\delta^{15}\text{N}$  isotopes to determine stream nitrogen cycling was developed in small tundra streams in Alaska (USA), but a network of researchers using similar technique has rapidly grown to answer questions about nitrogen cycling and stream food webs in a variety of ecosystem types and subject to human modifications. Here we provide an overview of some of the information that can be provided using stable isotope additions and describe the general approach of an isotope addition experiment. To illustrate the scope of isotope applicability some examples are provided of work undertaken in the Brazilian Amazon.

## 1. INTRODUCTION

Human activities now modify land use over a significant portion of the Earth's surface. Many of these changes have altered the biogeochemistry of soils and surface waters over large regions and influenced the movements of materials among adjoining ecosystems. For example, anthropogenic perturbations of the global nitrogen (N) cycle are now changing biological processes in soils and in streams, as well as rivers, lakes and estuaries [1].

One region undergoing significant land use change is the Amazon Basin, which contains more than 4 million km<sup>2</sup> of tropical forest and the Earth's largest river network. The Amazon Basin also has the world's highest rate of forest clearing, with more than 700 000 km<sup>2</sup> of forest cleared primarily for cattle pasture in the Brazilian territory alone since 1970 [2]. First and second order streams dominate the total length of stream channels in lowland Amazon and account for more than 80% of total channel length [3]. As the primary receptors and transporters of nutrients and organic matter inputs from land, small streams serve as the most direct and important link between upland and aquatic ecosystems [4–6]. Despite the enormity of current land use change in the Amazon, we know relatively little about the biogeochemistry of small streams that play a key role in connecting terrestrial ecosystems and larger rivers and estuaries.

Deforestation can have profound impacts on the biogeochemistry and ecology of aquatic ecosystems. Rapid clearing and burning of forest vegetation provides an initial pulse of nutrients and cations that may last for a few years [7, 8]. More permanent changes in streamside vegeta-

tion can cause chronic changes in the concentrations of nutrients in streams [9, 10] and alters the light regime and inputs of organic matter through removal of the overhanging tree canopy. These changes in nutrients and light can lead to changes in nutrient cycling, algal productivity, dissolved oxygen, ecosystem productivity and food webs [9].

The goal of this paper is to provide an introduction to an emerging new technique, the use of  $\delta^{15}\text{N}$  stable isotope tracers, which can provide insight into both short term and long term alterations of stream ecosystem nitrogen biogeochemistry and food web dynamics. The use of  $\delta^{15}\text{N}$  isotopes to determine stream nitrogen cycling was developed in small tundra streams in Alaska, USA [6, 11], but has rapidly developed into a network of researchers using similar techniques to answer questions about nitrogen cycling and stream food webs in a variety of ecosystem types and subject to human modifications (LINX: Lotic Intersite Nitrogen eXperiment: <http://www.biol.vt.edu/faculty/webster/linx/>). In this paper, we provide an overview of some of the questions that can be answered using stable isotope additions, describe the general approach of an isotope addition experiment and draw on our own work in the Brazilian Amazon and other locations to illustrate the utility of this approach.

### 1.1. The advantages of whole stream $^{15}\text{N}$ addition experiments

Additions of  $^{15}\text{N}$ -labeled  $\text{NH}_4^+$  or  $\text{NO}_3^-$  directly to streams can provide a range of information on stream biogeochemical and ecological functions (Table 1, Fig. 1). Stream  $^{15}\text{N}$  experiments can be conducted over different time frames depending on the questions asked. In addition, the source of  $^{15}\text{N}$  ( $\text{NH}_4^+$  or  $\text{NO}_3^-$ ) can vary as shown in Table 1. Short term additions in the time scale of hours to days can provide information on stream N biogeochemical transformations. The addition of  $^{15}\text{NH}_4^+$  allows calculation of the rate of N uptake into stream bottom biota and hence a measure of N travel, or spiralling, distance (Table 1). This is the distance in meters that an average molecule of  $\text{NH}_4^+$  will travel before being incorporated into stream bottom plants

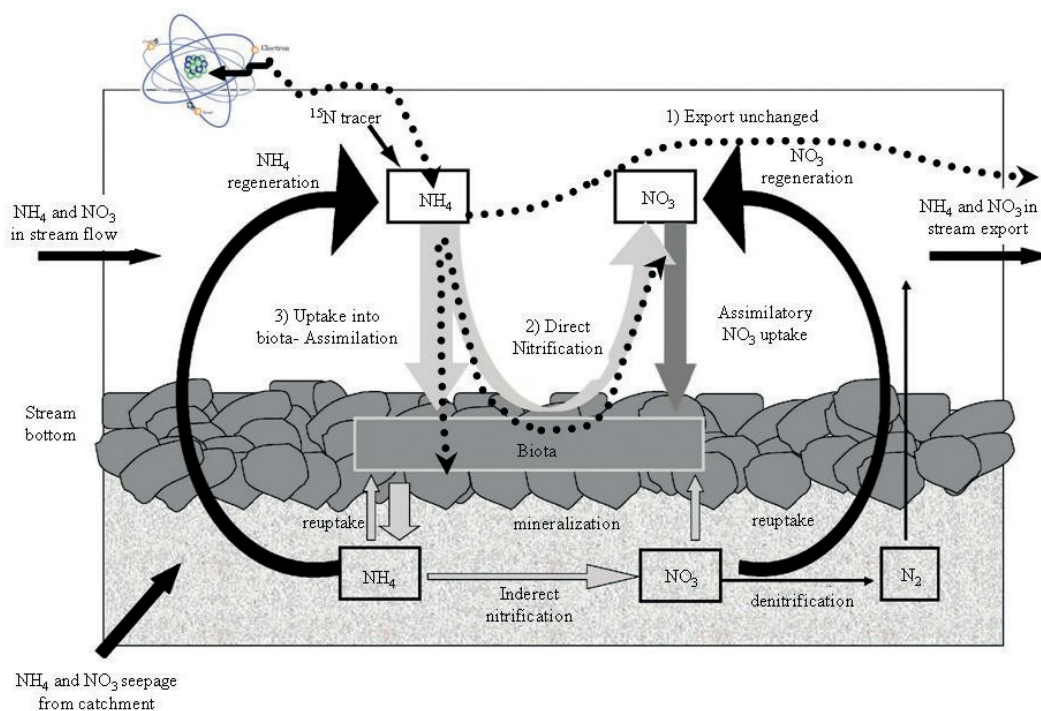

FIG. 1. Nitrogen cycling in stream ecosystems.



TABLE 1. EXPERIMENTAL FIELD ADDITIONS OF  $^{15}\text{N}$ -LABELLED INORGANIC N TO STREAMS<sup>a</sup>

Type of information	Time scale	Addition of $^{15}\text{NH}_4^+$	Addition of $^{15}\text{NO}_3^-$	Technical requirements
Biogeochemical N transformations	Hours/ days	Quantifies: (a) $\text{NH}_4^+$ uptake rate and travel distance; (b) rate of nitrification in stream channel and (c) can quantify $\text{NO}_3^-$ uptake rate and travel distance if nitrification rate is sufficient.	Quantifies $\text{NO}_3^-$ uptake rates and travel distance.	Accurate measurement of water discharge, $\text{NH}_4^+$ and $\text{NO}_3^-$ concentrations, and simultaneous addition of a conservative (e.g. $\text{Cl}^-$ or $\text{Br}^-$ ).  Distillation or diffusion to measure $^{15}\text{N}$ in $\text{NH}_4^+$ and $\text{NO}_3^-$ .
Fate of N	Weeks/ months	Quantifies N uptake and storage into organic matter different components and turnover rate of N in different organic matter components	Quantifies the amount of uptake and storage derived from $\text{NO}_3^-$ . Will under-represent total uptake because does not quantify uptake from $\text{NH}_4^+$ .	Accurate measurement of water discharge, $\text{NH}_4^+$ and $\text{NO}_3^-$ concentrations.  Distillation or diffusion to measure $^{15}\text{N}$ in $\text{NH}_4^+$ and $\text{NO}_3^-$ .  Measurement of stocks of different organic matter components.
Denitrification	Hours		Direct measurement of loss of $^{15}\text{NO}_3^-$ as $\text{N}_2\text{O}$ or $\text{N}_2$ gas.	Measurement of $^{15}\text{N}_2\text{O}$ and $^{15}\text{N}_2$ , which are technically challenging.
Food webs	Weeks/ months	Traces N into organic matter and food webs, provides information on food web relationships. $\text{NH}_4^+$ uptake is likely the dominant incorporation pathway in tropical streams.	Traces N into organic matter and food webs; provides information on food web relationships.  Utility for marking food webs will be limited in many streams due to low $\text{NO}_3^-$ uptake rates	Identification and collection of important components of food webs.

<sup>a</sup> This can produce a variety of information over different time scales, depending on the questions and whether N is added as  $\text{NH}_4^+$  or  $\text{NO}_3^-$ .



and bacteria. This is a typical measure of stream N cycling activity. Between hours to a few days, the generation of  $^{15}\text{NO}_3^-$  from added  $^{15}\text{NH}_4^+$  provides a direct measure of the rate of nitrification in a stream channel. If the production of  $\text{NO}_3^-$  from added  $\text{NH}_4^+$  is sufficient, uptake rates and travel distances for  $\text{NO}_3^-$  can also be calculated from  $^{15}\text{NH}_4^+$  additions [12]. Addition of  $^{15}\text{NO}_3^-$  can provide a direct measure of  $\text{NO}_3^-$  uptake distance and uptake rate into stream biota. However, addition of  $^{15}\text{NO}_3^-$  will likely cause a severe underestimation of total stream N uptake because much uptake occurs as  $\text{NH}_4^+$  [6]. In stream discharge, the concentrations of  $\text{NH}_4^+$  and  $\text{NO}_3^-$  and the  $\delta^{15}\text{N}$  of  $^{15}\text{NH}_4^+$  and  $^{15}\text{NO}_3^-$  are measured; such short term additions can provide a measure of the amount and forms of N that exit a stream reach. Differences between the mass of  $^{15}\text{N}$  added and the mass exiting a reach can provide a measure of the extent of N retained within a reach. More detailed information on the fate of N within a stream reach typically requires a longer period of weeks to months to accurately measure the  $^{15}\text{N}$  incorporated into different organic matter components (Table 1).

The utility of  $^{15}\text{N}$  in ecological studies is based on the fact that  $^{15}\text{N}$  comprises only 0.37% of all N atoms. The relative abundance of  $^{15}\text{N}$  relative to the more abundant  $^{14}\text{N}$  is expressed as delta values (‰), or deviations from standard reference materials (Eq. 1):

$$\delta^{15}\text{N} = [(R_{\text{sample}} / R_{\text{standard}}) - 1] \times 1000 \quad (1)$$

where:

$$R = ^{15}\text{N}/^{14}\text{N};$$

standard N in air ( $^{15}\text{N}_{\text{air}}/^{14}\text{N}_{\text{air}}$ ) = 0.0036765 [13].

The  $\delta^{15}\text{N}$  of most standard biological materials can be measured with high precision on modern mass spectrometers. Mass spectrometers are now widely available and prices for  $^{15}\text{N}$  determinations (about \$5 to \$20) and prices of 99%  $^{15}\text{NH}_4^+$  and  $\text{NO}_3^-$  (now about \$USD 40–65/g) have declined in recent years.

Additions of  $^{15}\text{N}$  offer several advantages over additions of unlabelled  $\text{NH}_4^+$  or  $\text{NO}_3^-$ . First, additions of  $^{15}\text{N}$  can contain relatively small amounts of N, which can change the isotopic composition of N in stream ecosystems while slightly changing the total N. Most tracer additions change total stream  $\text{NH}_4^+$  or  $\text{NO}_3^-$  concentrations by less than 1%. This approach maintains existing conditions in a stream, and can differentiate loss of reactive N (denitrification) from the temporary storage of nitrogen in biomass, and allows rates of nitrogen processing and biotic uptake to be assessed for an entire reach. Second,  $^{15}\text{N}$  additions provide information on the fate of added N in stream ecosystems over time. This includes information on N fluxes downstream and rates of N movement into and out of organic matter compartments. Tracer additions can also provide information on the structure of stream food webs, as N follows the main flow of organic matter. Naturally occurring N isotopes are typically enriched 1–3‰ at each trophic step, however, tracer additions are designed to overwhelm this small background change. Such background trophic enrichment can be accounted for in enrichment analyses [14].

## 2. STUDY AREAS

The study sites were located at Fazenda Nova Vida, a 20 000 ha cattle ranch in western Amazonia, Brazil (10°13'S, 62°19'W; Fig. 2). The land cover in this area is a mixture of tropical rain forest and cattle pasture. The forest reserves were selectively logged between 1987

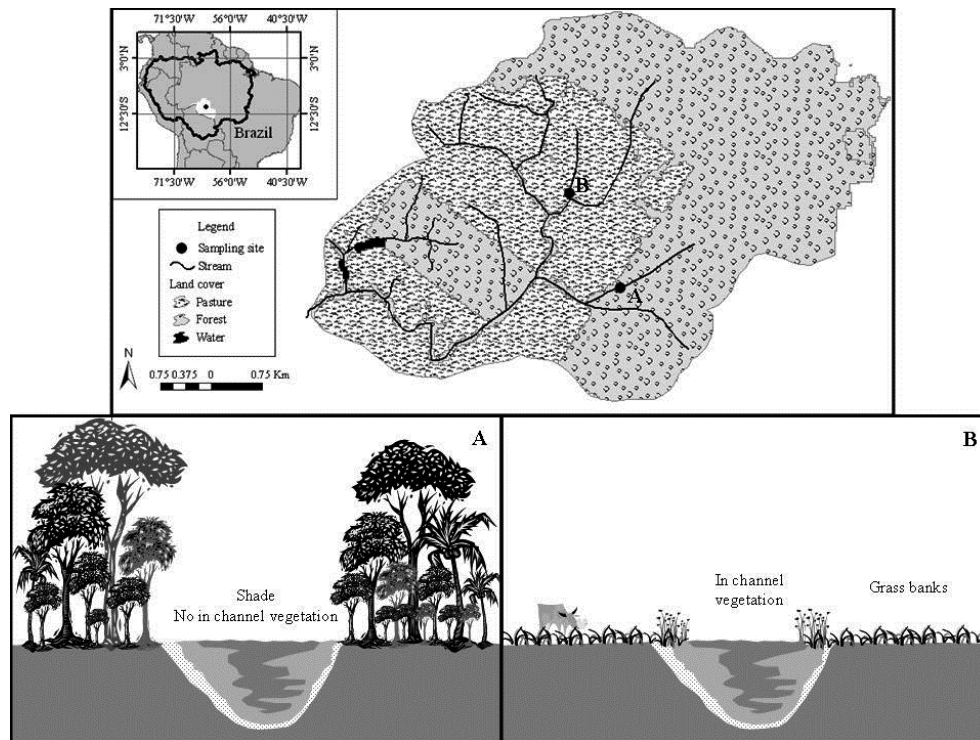

FIG. 2. Maps of the location and land use of the study areas, and diagrams of the forest (A) and pasture (B) sites.

and 1990, removing 1–2 trees/ha. Pastures were cleared in 1989 by cutting and burning to the stream edge, and then planted with *Brachiaria brizantha* in the uplands and *Paspalum spp.* in the floodplain. Pastures were not limed or fertilized [15]. This region is humid tropical, with a dry season from May to October. Average yearly precipitation is 2200 mm and the mean temperature is 26°C [16]. The bedrock is generally Precambrian granite and soils at the site are classified as Kandiudults and Paleudults [15, 17].

### 3. METHODS

#### 3.1. General experimental design

The experimental field setup is similar for all isotopic enrichment approaches described in this paper (Fig. 3). Nitrogen isotopes, in either liquid  $\delta^{15}\text{NH}_4^+$  or  $\delta^{15}\text{NO}_3^-$  form, are injected into the stream at a particular point. These mix with the water, and the longitudinal decline of the added enriched nutrient out of the water and uptake into other stream compartments is measured at downstream stations. The duration of the addition, the type of solute added, and the targeted enrichment varies with the experimental questions. To understand rapid nutrient cycling compartments, such as  $\text{NH}_4^+$  uptake, short experiments (hours to days) with high enrichments (up to 5000‰) can be used [18]. To understand food web pathways or storage in slow turnover organic matter compartments, longer duration experiments are used (weeks to months), often at lower enrichments (100 to 500‰) primarily because of costs (see Ref. [19]). Usually 10 stations are distributed along an experimental reach in a geometric series according to expected uptake. If uptake is expected to be fast, stations are located closer together near the injection point with only a few further downstream.

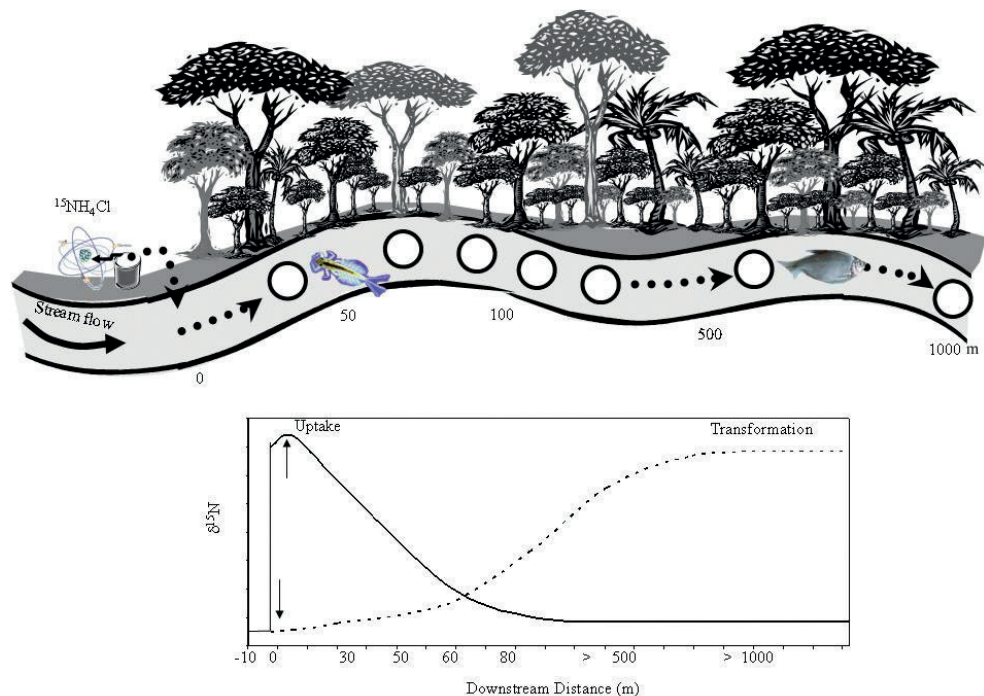

FIG. 3. Diagram of experimental setup showing sampling station distances (in meters) and  $\delta^{15}\text{N}$  theoretical curves of uptake and transformation along the transect.

TABLE 2. TYPICAL PARAMETERS DETERMINED FROM WHOLE STREAM  $^{15}\text{N}$  ADDITION EXPERIMENTS TARGETING BIOGEOCHEMICAL TRANSFORMATIONS

Parameter	Description	Units
$\text{NH}_4^+$ or $\text{NO}_3^-$ uptake length	Average distance travelled by a $\text{NH}_4^+$ or $\text{NO}_3^-$ molecule before it is taken up by the stream bottom biota	m
$\text{NH}_4^+$ or $\text{NO}_3^-$ uptake rate	Rate at which $\text{NH}_4^+$ or $\text{NO}_3^-$ is taken up by stream bottom biota	$\mu\text{g}\cdot\text{N}\cdot\text{m}^{-2}\cdot\text{min}^{-1}$
Uptake velocity	Vertical velocity of $\text{NH}_4^+$ or $\text{NO}_3^-$ molecules	$V_f$ (mm/s)
Residence time	Residence time of N in organic matter components. Calculated as total standing stock of N in organic matter compartment/uptake rate of $\text{NH}_4^+$ + $\text{NO}_3^-$ into that compartment	min
Nitrification rate		$\mu\text{g}/\text{min}$

Most  $\delta^{15}\text{N}$  additions have been undertaken on relatively small streams (1st and 2nd order) because isotope costs are proportional to stream discharge and background N concentrations [14]. The experimental stream reach selected should be reasonably uniform in basic characteristics (including discharge, geomorphology, habitat types, structure, species composition) and should have minimal input from groundwater or surface water sources over the entire experimental reach. For small streams (discharge of less than  $0.5 \text{ m}^3/\text{s}$ ), an experimental reach is typically between 100 and 1000 m, depending on the expected rate of uptake by the stream. The typical reach has been 200–300 m, however for streams of low N metabolic activity, stream reaches of up to 1000 m have been used.

Stream components measured in the experiment vary with the question addressed (Table 2). For example, whole stream uptake of  $\text{NH}_4^+$  or  $\text{NO}_3^-$  can be determined either by depletion of

the flowing water [20] of the added inorganic nutrient or the uptake into fast turnover compartments such as algae [14]. Food web analysis or determination of N fate requires sampling standing stocks and long term storage compartments such as detritus and fish. Overviews of typical approaches used in sampling and analysing individual compartments are provided in Appendices I–IV. Additional information is available on the LINX web site (<http://www.biol.vt.edu/faculty/webster/linx/>), in Refs [14, 21].

## 4. RESULTS AND DISCUSSION

### 4.1. Examples of using $\delta^{15}\text{N}$ additions to answer specific questions

#### 4.1.1. Nitrogen transformations

Understanding nitrogen cycling in small streams is important because N can limit stream production, stream biota can respond to N enrichment and because small streams have the potential to process N and affect downstream transport to the ocean [6, 22]. Uptake lengths in streams are determined through a combination of physical attributes and geomorphology (temperature, stream width, depth, substrate), hydrology (discharge, flow path into substrate), nutrient concentrations, and biotic activity.

We have conducted a series of  $\delta^{15}\text{N}$  additions to small streams in central Rondônia (Fig. 2) to examine changes to N cycling in relation to deforestation and conversion of adjacent land to pasture. Our prior work had shown elevated levels of  $\text{NO}_3^-$  in forest streams compared to pasture streams, suggesting that either  $\text{NO}_3^-$  uptake or production (nitrification) differed between streams with different land cover. To answer this question, we added  $\delta^{15}\text{NH}_4^+$  (target enrichment  $\sim 500\text{‰}$ ) to small forest or pasture streams for a period of six weeks and measured stable isotope enrichment of  $\text{NH}_4^+$  and  $\text{NO}_3^-$  (Fig. 4). Comparison of  $\text{NH}_4^+$  and  $\text{NO}_3^-$  enrichment levels in the forest stream downstream of the injection point illustrates the depletion of  $\delta^{15}\text{N}$  in  $\text{NH}_4^+$  and the subsequent production of enriched  $\text{NO}_3^-$  (Fig. 4a). This production of enriched  $\text{NO}_3^-$  can only have come from added enriched  $\text{NH}_4^+$  and thus provides an estimate of the rate of  $\text{NO}_3^-$  production. By comparing the rate of enriched  $\text{NO}_3^-$  production immediately after adding enriched  $\text{NH}_4^+$ , before the enriched  $\text{NH}_4^+$  could be incorporated into biomass and recycled, we can obtain an estimate of the direct production of  $\text{NO}_3^-$  from  $\text{NH}_4^+$  in the water column. Later in the process of addition, the increase in  $\text{NO}_3^-$  is a combination of direct and recycled  $\text{NH}_4^+$  conversion to  $\text{NO}_3^-$ .

Comparison of enrichment levels in  $\text{NO}_3^-$  across forest and pasture streams can be used to determine if rates of nitrification differ with surrounding land use (Fig. 4b). In this example, the lower level of  $\text{NO}_3^-$  enrichment in the pasture stream, given that the initial enrichment of added  $\text{NH}_4^+$  was similar in the forest and pasture streams, implies a lower rate of nitrification. To quantitatively estimate the nitrification rate, the level of enrichment must be integrated with stream flow and nutrient concentration levels in a mathematical model to estimate the uptake length and rate, as well as the rate of nitrification [12]. The use of a mathematical model to estimate actual rates allows comparison across streams of very different flow rates, biotic characteristics and experiments with different enrichment levels.



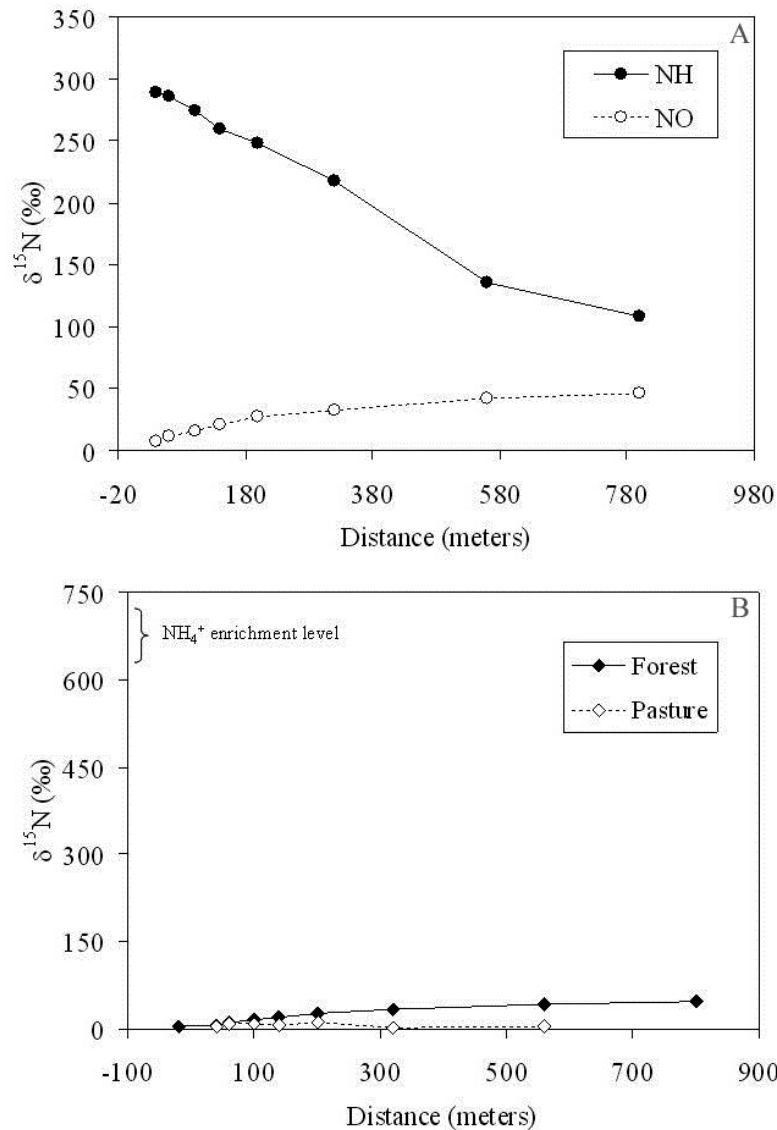

FIG. 4. Nutrient transformations within streams and comparisons across streams; (A)  $\text{NH}_4$  versus  $\text{NO}_3^-$  dynamics within a single stream and (B) comparison of  $\text{NO}_3^-$  production across ecosystems.

#### 4.1.2. Fate of N

Understanding the rate and pathway of N transformation is important, however, a more complete understanding of nitrogen retention and fate is needed to better predict the effects of human alterations of watersheds on streams. For example, in addition to understanding how rapidly inorganic forms of N are transformed, we also need to know whether the transformed nitrogen is exported or stays in the system and which components of ecosystems are quantitatively most important in the retention of N. The fate of N can be determined through enrichment studies by combining enrichment levels and standing stocks of stream compartments, such as fine, coarse or woody benthic organic matter, vegetation and nutrients, into a budget for the added  $^{15}\text{N}$ . Additions of  $\delta^{15}\text{N}$ , for example, can be used to examine whether streams of different sizes within the same surrounding land use differ in their processing and retention of N. Our work comparing the export and retention of  $\delta^{15}\text{N}$  across streams of different size within a single land use (pasture) suggests very different processing rates and fates of N with stream

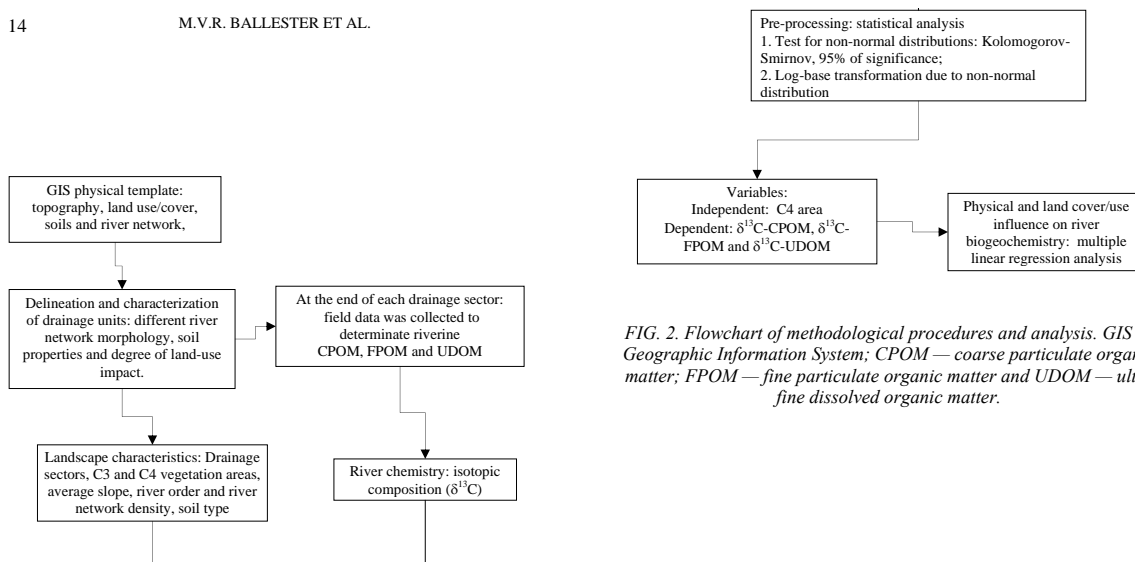

FIG. 2. Flowchart of methodological procedures and analysis. GIS—Geographic Information System; CPOM—coarse particulate organic matter; FPOM—fine particulate organic matter and UDOM—ultra fine dissolved organic matter.

FIG. 5. Values obtained in this study of nitrogen retention and export in two streams in Amazonia.

size (Fig. 5). In this tropical example, larger streams tend to export more N in inorganic forms, while small pasture streams retained a larger fraction of added  $\delta^{15}\text{N}$  in riparian vegetation. Information on differential processing according to stream size is essential to predicting the fate of N in a stream network. In stream networks, any  $\text{NO}_3^-$  not removed within a reach passes to the next reach downstream, where it may be subsequently processed and either retained or exported further downstream, eventually reaching the coastal ocean. This finding underscores the importance of controlling the amount of nitrates reaching coastal waters in river channels of all sizes.

#### 4.1.3. Denitrification

Recent stable isotope experiments have focused on denitrification rates and how they vary among natural and human altered systems [22]. Denitrification is an important process that can transform reactive nitrogen into an inert gas (Fig. 2), thus removing nitrogen from the ecosystem and reducing delivery to downstream ecosystems. Unfortunately, the many techniques developed to measure denitrification all have their shortcomings, making comparisons of rates across techniques problematic and the linking of river and watershed characteristics to denitrification and N removal difficult. Recently, Mulholland et al. [22] developed a new approach using  $\delta^{15}\text{N}$  additions and applied this to 72 streams across multiple temperate biomass and land use characteristics to understand the role of denitrification in N removal in streams. They added trace amounts of  $\delta^{15}\text{NO}_3^-$  at extremely high enrichment levels ( $> 10\,000\text{‰}$ ) for 24 hours during spring or summer and measured increases in  $^{15}\text{N}_2$  and  $^{15}\text{N}_2\text{O}$  from denitrification. Decreases in labelled nitrate not accounted for by an increase in labelled  $\text{N}_2$  and  $\text{N}_2\text{O}$  were attributed to uptake by plants and microbes. They found measurable rates of nitrate removal occurred through biotic uptake and denitrification, and that absolute rates of removal generally increased as nitrate concentrations increased. But the efficiency of nitrate removal—the proportion of nitrate removed relative to the total amount present—decreased exponentially as nitrate concentrations increased. They also found that  $\text{NO}_3^-$  removal efficiency via denitrification declined with increasing  $\text{NO}_3^-$  concentration. Although this approach has not been applied



to tropical streams, it provides a new approach to estimating the fraction of  $\text{NO}_3^-$  removal observed in pasture streams, which may be due to denitrification versus storage in organic matter.

#### 4.1.4. Food webs

Stable isotope N additions can also be instrumental in determining rates and pathways of nitrogen flow through food webs. Food webs describe the trophic relationships and energy flow among organisms in streams. Food webs can be based on either in-stream production (autochthonous) such as algae or submerged vascular plants or dependent on inputs from outside the stream (allochthonous), such as leaf fall from trees. Stable isotope additions can provide information on linkages between organisms within a system, similar to a food web diagram derived from gut content analysis, but also provides information on sources of organic matter at the base of the food web and rates of transfer among food web components. The rate at which enrichment increases in different animals also provides insight into their trophic placement.

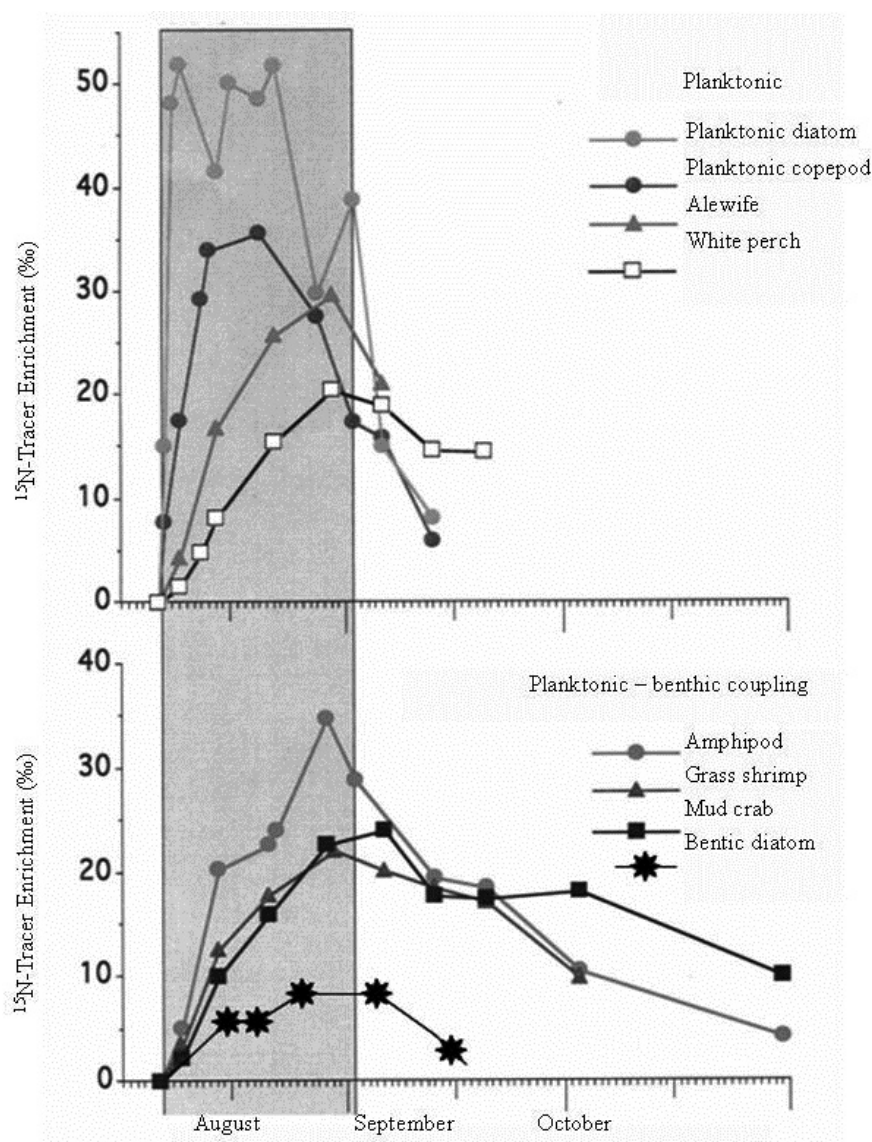

FIG. 6.  $\delta^{15}\text{N}$  uptake rates of different producer components within the stream obtained in this study in two ecosystems in Amazonia.

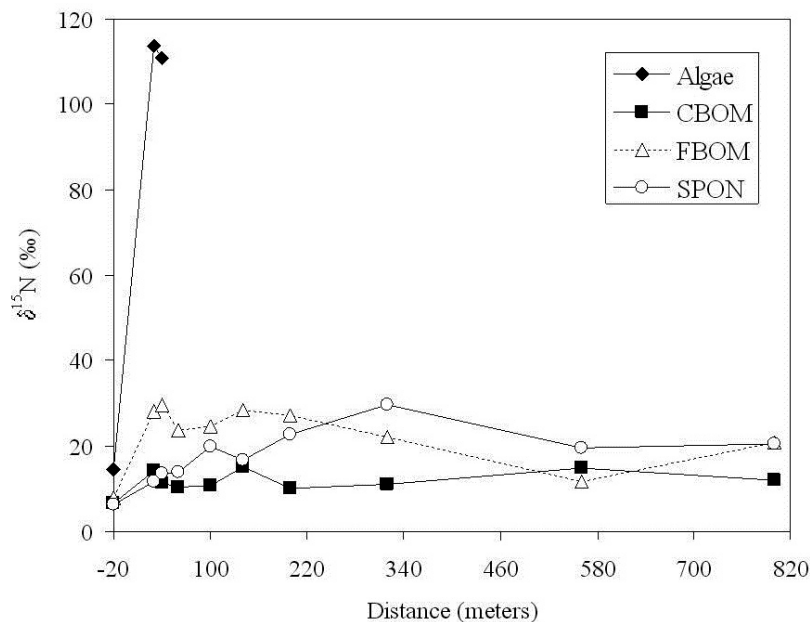

FIG. 7. Sources of organic matter differentiated using  $^{15}\text{N}$  additions in two streams in Amazonia.

Animals high up in the food web will take longer to become enriched as the material must first be processed by lower trophic levels. The addition of  $\delta^{15}\text{N}$  to determine food webs must occur over a long time period (often 6 to 12 weeks) to allow the  $\delta^{15}\text{N}$  to move through the ecosystem from plants and microbes up to the top consumers. Ideally, the experiment should run for long enough that the highest consumer of interest has reached its maximum and stable  $\delta^{15}\text{N}$  value and until the level of enrichment is high enough that natural trophic enrichment can be ignored or only accounts for a small fraction of the change [23]. The rate of enrichment and ultimate enrichment level in primary producers and organic matter sources can provide insight into rates and pathways of N flow through food webs.

One useful aspect of isotopic enrichment is that different producer components within the stream will take up the  $\delta^{15}\text{N}$  at different rates, depending on their access and requirements, thus allowing differentiation among producers within a system (Fig. 6). In a north temperate tidal river [19], unexpected linkages were found between planktonic production and benthic organisms that were not predicted based on typical gut content analysis. In this example, planktonic algae (diatoms) were highly labelled (up to 60‰), while benthic diatoms only achieved 10‰  $^{15}\text{NH}_4^+$ . Based on classic food web analyses which suggested that the benthic food web was based on benthic production, our prediction was that benthic organisms, such as amphipods, would become enriched only to the level of benthic diatoms. Instead, we found that many of the benthic organisms (lower panel) became almost as highly enriched as the planktonic organisms (upper panel), signifying a previously unknown link between the benthic and pelagic food webs. Additionally, benthic organisms became enriched at the same rate as pelagic organisms, suggesting that they were grazing on planktonic diatoms directly and not through a detrital pathway.

The addition of  $\delta^{15}\text{N}$  is also useful for differentiating between in-stream production (autochthonous) and inputs of organic matter from adjacent land (Fig. 7). For example, the uptake of added  $\delta^{15}\text{NH}_4^+$  by plants and algae in a stream will result in  $\delta^{15}\text{N}$  enrichment of in-stream pri-

mary producers, followed by the animal consumers that use those plants. Detrital inputs, such as leaves from adjacent trees, will remain relatively unenriched, as will the animals that feed on this leaf detrital material. In our addition to a tropical forest stream, algae became highly labelled (up to  $120\text{‰}$   $^{15}\text{NH}_4^+$ ), while all size classes of detrital material, which was derived from tree leaves, was less unenriched. The entire community of stream insects most closely followed the pattern and level of enrichment of the detrital material, suggesting a high dependence on organic matter input from outside the stream ecosystem. Because these streams are highly shaded by dense overhanging trees, algal production is minimal and thus its contribution to the food web was limited.

## 5. CONCLUSIONS

In recent years, the use of stable isotopes to determine the biogeochemistry and food webs of streams has become common enough to be considered a standard method [24]. Advances in mass spectrometry are allowing the analysis of smaller samples and of a wider spectrum of tissues and gases. One advantage of  $\delta^{15}\text{N}$  enrichment experiments is that they have the potential to provide information simultaneous on aspects of both biogeochemistry and food webs. Through the application of similar enrichment across stream types and biomes, it is possible to develop predictive models of the implications of human change on stream ecosystem function.

## ACKNOWLEDGEMENTS

This is a publication of the international collaboration between the Centro de Energia Nuclear na Agricultura – USP and the Marine Biological Laboratory as part of the Large Scale Biosphere-Atmosphere Experiment in Amazonia (LBA). Research was sponsored by the Fundação de Amparo à Pesquisa do Estado de São Paulo (FAPESP, Processes numbers 99/01159–4 and 03/13172–2) from Brazil and by the National Aeronautics and Space Administration (NASA) from USA (LBA-ECO, ND–03).

## Appendix I

### OVERVIEW OF $^{15}\text{N}$ AMMONIUM, NITRATE, AND TDN PROTOCOLS FOR NOVA VIDA $^{15}\text{N}$ ADDITION

The methods presented here ( $\text{NH}_4^+$ ,  $\text{NO}_3^-$ , and TDN concentrations, volume of sample, amount of reagents, etc) are adapted from the LINX protocols and are specific for experiments conducted at Nova Vida (RO, Brazil). For the original procedures, consult the cited sources and adapt for site specific nutrient concentrations and working environment. All the  $\delta^{15}\text{N}$  methods described here rely on converting  $\text{NH}_4^+$  to  $\text{NH}_3$  (by increasing pH with  $\text{MgO}$ ) and then trapping the  $\text{NH}_3$  gas on an acidified filter pack floating on top of the sample. This is straightforward for  $\text{NH}_4^+$  samples. For  $\text{NO}_3^-$ , we first drive off the  $\text{NH}_4^+$  and then convert  $\text{NO}_3^-$  to  $\text{NH}_4^+$  with Devarda's alloy. For  $\text{TDN}^{15}\text{N}$ , we first oxidize all forms of nitrogen to  $\text{NO}_3^-$  and then convert  $\text{NO}_3^-$  to  $\text{NH}_4^+$ . For both field and lab work, always start with a control sample and work from low enrichment to high. To minimize contamination problems, it is advisable to avoid the use of extra containers to measure sample volumes by using pre-calibrated  $\text{NH}_4^+$  diffusion bottles and  $\text{NO}_3^-$  beakers with a mark at the appropriate height.

**Sampling Procedure:** Use a station-dedicated collection bottle to minimize contamination problems. Rinse the bottle 3 times with stream water and collect 4L of unfiltered stream water and keep cool until the sample can be filtered back in the lab. This 4L will be used for  $\text{NH}_4^+$  (2 L),  $\text{NO}_3^-$  (750 mL), and TDN (200 mL), as well enough extra sample for rinsing the filtration apparatus and bottles. Also collect nutrient, chlorophyll, and water for PON/POC and TSS filtration. These data will be useful to accompany the  $^{15}\text{N}$  data. In the lab, rinse the filtration apparatus (a 14.2 cm filter holder with ashed GF/F filter using a battery-operated Geopump),  $\text{NH}_4^+$  diffusion bottle,  $\text{NO}_3^-$  beaker, and TDN bottle. Filter 2 L of stream water into a 2.5 L  $\text{NH}_4^+$  diffusion bottle. Follow the  $^{15}\text{NH}_4^+$  (for 2 L) protocol below. Similarly filter 750 mL of stream water into a 1 L beaker for  $^{15}\text{NO}_3^-$  analysis and 250 mL into a bottle to be frozen and analysed for  $\text{TDN}^{15}\text{N}$  later.

**Making Filter packs with Teflon Tape:** Many experiments have used teflon membrane filter packs which are easy to use and neater in appearance. The teflon membranes are expensive, however, and could be cost-prohibitive for some projects. Instead we make the filter packs using less expensive and easily obtainable teflon tape from plumbing supply or scientific catalogues. Both approaches work equally well, it just depends on how much money and time you have to devote to this aspect. NOTE: Make the filters the day you intend to use them. The longer they sit around the more likely they are to become contaminated by atmospheric  $\text{NH}_3$ .

#### Materials:

- 1 cm diameter GF/D filters (ashed);
- Wide Teflon tape (1" wide);
- 2 M  $\text{H}_2\text{SO}_4$ ;
- Pipette (for 25  $\mu\text{l}$ );
- Aluminium foil; EtOH and kim wipes;
- Glass scintillation vial;
- Filter forceps;
- Clean and dry plastic bottle (to store filters in).

Wear gloves. On clean counter top, place several layers of paper towels underneath a clean sheet of aluminium foil. Wipe the aluminium foil, filter forceps, and the top rim of the scint vial with EtOH.

- (1) Place 1 piece of teflon tape (approx. 7 cm long) on the aluminium and wipe both sides lightly with EtOH (too much EtOH will make the tape curl).
- (2) Place an ashed 10 mm GF/D filter on top of the piece of Teflon tape.
- (3) Pipette 25  $\mu$ l of 2M H<sub>2</sub>SO<sub>4</sub> onto the filter.
- (4) Fold the Teflon tape in half, keeping the acidified filter in the centre of the folded half.
- (5) With a clean scint vial, press the folded teflon tape together to form a ring around the GF/D. To do this, press the vial around its entire perimeter on an angle. The ring where the teflon tape has been pressed together should be visibly thinner and should allow some light through, but should not be torn. If you press too hard the tape will tear, but if you press too lightly the tape will not be truly stuck together and may come apart during the incubation. If this happens the sample is ruined. Make sure the teflon tape is pressed together in a complete ring. You will need to practice this before your experiment.
- (6) Place filter packs in a clean storage bottle until you're ready to add them to the diffusion bottle.
- (7) Cap tightly to prevent atmospheric NH<sub>3</sub> from diffusing onto the acidified filter. Always minimize exposure to the air. Once you are comfortable making these, you will be able to do five or so at time in assembly line fashion. Don't leave the filters sitting out too long.

## Appendix II

### $^{15}\text{NH}_4$ PROTOCOL

#### Materials:

- Acid washed diffusion bottles (2.5 L);
- Filter packs;
- NaCl ash (Fisher certified ACS);
- NaCl scoop (for 100 g aliquots);
- MgO ash (Fisher certified ACS);
- MgO scoop (for 6 g aliquots);
- Geopump peristaltic pump;
- 14.2 cm diameter filter holders;
- 14.2 cm ashed GF/F's;
- Batteries for Geopump;
- Desiccator with small beaker of concentrated  $\text{H}_2\text{SO}_4$ ;
- Shaker table (to shake and incubate at  $40^\circ\text{C}$ );
- Scintillation vials;
- $\text{NH}_4$  standard (10 mM  $(\text{NH}_4)_2\text{SO}_4$ , with known delta values).

**$\text{NH}_4$  standards:** Make one set of diffusion standards with each set of samples. Start the diffusion standards at the same time as the samples. Fill these sample bottles first because the diffusion standard used for NV is a natural abundance standard, not enriched. Fill eight 2.5 L plastic jars with 2 L of deionized water (bottles should be pre-calibrated to avoid using graduated cylinders that may lead to cross-contamination). To achieve two replicate standards of 0, 3, 5, and 10  $\mu\text{M}$   $\text{NH}_4^+$ , add 0, 0.9, 1.5, and 3 mL, respectively, of 10 mM  $(^{15}\text{NH}_4)_2\text{SO}_4$  stock standard to each pair of bottles. Then add the salt, filter pack, and MgO, as below. The  $\text{NH}_4$  standard is to determine the % recovery in these large volume diffusions.

#### Samples:

- (1) Be sure to work from the reference station (no enrichment) first then to the most-downstream station (least enrichment) up towards the dripper (most enrichment) to avoid contamination.
- (2) Turn on the Geopump and rinse the tubing, filter holder, and bottle with sample (several hundred mL).
- (3) Filter 2 L of sample into a pre-calibrated 2.5 L plastic bottle.
- (4) Add 100 g NaCl (use a plastic scoop or glass beaker and calibrate for 100 g; it doesn't have to be exact ( $\pm 5$  g)).
- (5) Cap sample and shake to dissolve salt.
- (6) Using clean forceps, add filter pack (note: the filter packs contain acidified GF/D filters, they trap  $\text{NH}_3$ , therefore, to avoid contamination, it's important to keep contact with the air and any other surfaces to a minimum).
- (7) Immediately add 6 g MgO (it is possible to calibrate the scoop used for MgO since the required amount is between 6 and 6.5 g).
- (8) Close diffusion bottle tightly (make sure it is closed as tightly as possible).
- (9) Gently swirl to distribute the MgO.



- (10) Place sample on shaker table at 40°C for two weeks ( $\pm$  1 day).
- (11) After two weeks, remove filter packs from bottle and place in clean (acid-washed or ashed), labelled 20 mL scint vials.
- (12) Place uncapped scint vial in desiccator with a small beaker of concentrated  $\text{H}_2\text{SO}_4$  to dry (the sulphuric acid acts as an acid trap for any atmospheric  $\text{NH}_3$  that might diffuse in).
- (13) When dry (usually about two days) remove the scint vial from desiccator and cap tightly.
- (14) Just before running on mass spec, peel apart Teflon and remove a GF/D filter.

## Appendix III

### $^{15}\text{NO}_3$ PROTOCOL

#### Laboratory materials:

- Hot plates with stirrer bars;
- 1 L beakers for boiling;
- Weighing boats;
- NaCl and MgO ashed;
- 250 mL HDPE bottle;
- Filter packet;
- Devarda's alloy (do not ash, if old, follow "Reactivation of Devarda's Alloy");
- $\text{NO}_3^-$  standard (10 mM  $\text{KNO}_3$  with known delta value);
- Shaker table, desiccator as for  $\delta^{15}\text{NH}_4^+$  determinations.

**Nitrate Standards:** For each set of nitrate samples, prepare two blanks and a 10  $\mu\text{M}$   $\text{NO}_3^-$  standard of known  $^{15}\text{N}$  content. We will be using a natural abundance standard, so prepare the standards first, and then the enriched samples. Use the same volume of DI as will be used for the sample volumes. If boiling 750 mL, add 0.75 mL of the 10 mM stock standard. Add reagents, boil and diffuse as below. The standard is to ensure 100% recovery has occurred.

#### Samples:

- (1) Filter samples as detailed in  $^{15}\text{NH}_4$  method and pour 750 mL of water into an acid-washed 1 L beaker (to avoid contamination calibrate the beaker to measure this out).
- (2) Add 2 g ashed NaCl to beaker.
- (3) Add 0.38 g ashed MgO to beaker.
- (4) Add stir bar and place on hot plate with stirring capability.
- (5) Heat and stir until volume is reduced to roughly 100 mL (doesn't have to be exact use from 75 to 125). Aim for a simmering boil, but if just below this then that's fine as well. Stir during the boil (this speeds evaporation and prevents excessive boiling). The speed at which the sample volume is reduced to 100 mL depends upon the starting volume and type of sample, but this will typically take between one and several hours.
- (6) After cooling, pour the 100 mL into an acid-washed 250 mL plastic bottle.
- (7) Add an additional shot (~ 0.2 g) of MgO (this reagent just needs to be in excess).
- (8) Swirl.
- (9) Add a filter pack.
- (10) Add 0.3 g of Devarda's alloy (< 0.33 g). You will need to quantify the N-blank associated with those lots.
- (11) Swirl and cap tight quickly.
- (12) **Make sure you add the Devarda's at the very end — this will convert the  $\text{NO}_3^-$  TO  $\text{NH}_4^+$  (which will be converted to  $\text{NH}_3$  due to the basic conditions).**
- (13) Place on shaker table at 40°C for 7 days. **The bottles will expand due to the gas being released. Re-tighten caps daily (without releasing the pressure).**
- (14) Remove filter pack and place in a clean (acid-washed or ashed), labelled 20 mL glass scintillation vial.

- (15) Place vials (uncapped) in a desiccator with a small beaker of concentrated  $\text{H}_2\text{SO}_4$  until dry, about 1–2 days.
- (16) Store tightly capped.
- (17) Before running on the mass spec, peel apart the teflon filters and place GF/D filter in mass spec sample boat.

**Reactivation of Devarda's Alloy:** If the Devarda's alloy that you will use is several years old, you may want to consider re-activating it since the metal surfaces may oxidize over time (this could be quite critical in hot, humid environments). This oxidation of the surfaces may reduce the efficiency of the conversion of  $\text{NO}_3^-$  to  $\text{NH}_4^+$ . To reactivate the Devarda's:

- (1) In a vacuum filtration setup (47 mm diameter is a good size) with clean filter, place the amount of Devarda's to be cleaned.
- (2) Quickly rinse the Devarda's with 10% HCl (10 seconds or so) while pump suctioning HCl from the Devarda's. You will most likely see bubbling.
- (3) Immediately wash the Devarda's with copious amounts of deionized water until absolutely sure that all acid has been rinsed off.
- (4) Rinse with deionized water again (just to be sure).
- (5) Vacuum filtration should dry the Devarda's quite well, but place clean Devarda's in a drying oven for approximately  $\frac{1}{2}$  hour ( $\sim 120^\circ\text{C}$ ) to ensure dryness.
- (6) Cap tightly until ready to use.

## Appendix IV

### DETERMINATION OF $\delta^{15}\text{N}$ OF ORGANIC MATTER

Because sampling for benthic organic matter (BOM) and invertebrates may be somewhat disruptive, it should be done approximately two weeks prior to  $^{15}\text{N}$  addition (to allow recovery from any disturbance during sampling). It may be necessary to sample macroinvertebrates and BOM again at the end of the  $^{15}\text{N}$  addition if it appears that there have been substantial changes in invertebrate densities and BOM standing stocks. Sampling of each of the bulk type compartments (e.g. CBOM, FBOM, epilithon, filamentous algae, bryophytes, etc.) should use standard methods appropriate for each stream (such as transect sampling or stratified random sampling). For CBOM, if both woody and leaf material is distinguishable and important, then it might be best to get the biomass of each type separately. For FBOM, determine total biomass using the most appropriate method for the site (such as removal of all material within a cylinder placed into the sediments). If sediments are deep, it would probably be best to sample to a standard depth of 10 cm (since it is unlikely that the  $^{15}\text{N}$  would move farther into the sediments than that depth). In the case of bryophytes, see the sampling protocol developed by Breck Bowden. This protocol may also be appropriate for filamentous algae if they are rather patchily distributed. For the organism type compartments (including grazers, shredders, invertebrate predators, vertebrate predators) use sampling methods appropriate for the site. If several species within a compartment are important contributors to the total biomass of that compartment and will be sampled separately for  $^{15}\text{N}$  analysis, then their biomass within the reach and their average N content should be determined separately. All samples should be dried ( $60^\circ\text{C}$ ) and ground. One portion of the sample is analyzed for %N and another portion is weighed, combusted at  $500^\circ\text{C}$  for  $> 4$  hours, and reweighed to determine ash free dry mass (AFDM) and AFDM/dry mass ratio.

#### Suspended Particulate Organic Nitrogen (SPON)

**Materials:** 25 mm GFF ashed filters and filtration assembly glass vials for storage. Procedure—collect material from FBOM accumulations that are most available to collector/gatherers by suctioning off the stream bottom and filtering the slurry onto pre-combusted GF/F filters, place in scintillation vial, and dry at  $60^\circ\text{C}$  (one blank filter included on each sampling date). Try to avoid collecting inorganic material (e.g. sand) as much as possible (we want the organic rich sediment deposits). On some sampling dates or at some stations you may want to stratify the sampling by habitat type (e.g. pool, riffle).

#### Coarse Benthic Organic Matter ( $> 1$ mm) (CBOM)

**Materials:** Nitex screen (1mm mesh) for filtering size fraction of OM; corer for quantitative sampling (make from bucket or small trash can).

**Procedure:** collect by removing appropriate size material from the bottom, dry at  $60^\circ\text{C}$ , grind, and place ground material into a scintillation vial. On some sampling dates it would be best to collect separate samples of different types of material if they are important contributors of CBOM (e.g. woody material, leaf detritus).

## **Benthic Microalgae (BMA)**

**Materials:** Nitex screen to capture BMA size fraction. Dissecting microscope and light Sedi-ment corers GFF filters and filtration apparatus to concentrate BMA onto filter Plastic scintilla-tion vials for sediment *Chl* determination Filamentous algae – (Benthic Macro Algae): Materi-als: scintillation vials for algae; GFF filters and filtration apparatus to concentrate BMA onto filter. Procedure: Pick from stream bottom and place in 50 mL centrifuge tube w/ some stream water to keep moist. Back in the lab, using a dissecting scope remove as much detritus as pos-sible. Place in scintillation vial (it might be necessary to collect this material on a GF/ F filter) and dry at 60°C. Need at least 2 mg of dry algal material.

**Epilithon:** Materials: Ashed GF/F filters. Epilithon samples should be scraped from rock sur-faces of known area and the scraped material collected on a pre-combusted and weighed glass fiber filter (Whatman GF/F). This component may also be qualitatively assessed by placing small unglazed 100 cm<sup>2</sup> ceramic tiles in the stream for 2 weeks prior to the experiment and then sampling the tiles.

Replicate samples for chlorophyll analysis of epilithon should also be taken at the time of epi-lithon biomass sampling. Chlorophyll should be determined using a 95% acetone extraction (24 hours in refrigerator in the dark) unless a more rigorous method is needed.

**Procedure:** Using a brush (or something comparable), scrub colonized tile surfaces to pro-vide at least 2 mg (dry mass) of material from each station. May need to pool two or more tile samples from each station. Pour scrubate into 50 mL centrifuge tube (or equivalent). Back in the lab, filter the material onto pre-combusted GF/F filter (25 mm diameter), place filter in scintillation vial and dry (60°C). Include one blank filter per sampling period. Sample stations in the following order: reference, then downstream to upstream (lowest <sup>15</sup>N to highest <sup>15</sup>N) in the labelled reach. Filter a parallel sample onto a 2nd GF/F filter for chlorophyll determination.

## **Invertebrates**

### **Materials:**

- Surber sampler for quantitative sampling;
- Trays for sample sorting tweezers;
- Sample containers;
- Alcohol;
- Dip nets;
- Aquarium nets;
- Sweep nets;
- Ashed GF/F filters.

**Procedure:** Sample all common taxa and place at least 5 individuals (or as many as needed to equal 1 mg dry weight) of each taxa in separate scintillation vials. Concentrate on most com-mon taxon from each functional feeding group that occur throughout the reach in order to get a complete transect (you may wish to collect representatives of a more than one taxon from a particular feeding group on days 7, 14, and 21 if more than one taxon is an important con-tributor to that feeding group). Also, try to get a complete transect of the dominant organism in each compartment (e.g. grazer, shredder, filterer, predators). Back in the lab, remove the organ-isms from the vials, rinse the vials, and add filtered stream water. Place the organisms back into their vials and allow to sit overnight for gut clearance so that the measured <sup>15</sup>N will not reflect

unassimilated food particles in the gut. Then dry (60°C), grind and place in a scintillation vial or place in alcohol for identification. Need about 1 mg of dry material per sample.

## **Vertebrates**

### **Materials:**

- Two small seines for partitioning stream;
- One large seine for fish collection;
- Electroshocker;
- Minnow traps (2–4 per station);
- Long-handled dip nets.

**Procedure:** It is probably best to focus on the youngest age class of fish or small body sized species because it is more likely that they will pick up measurable  $^{15}\text{N}$  during the study than large adults. Depletion of animals may be a problem in many streams, so a selection of sampling dates and stations will be important. It might be best to choose one central station to sample from on most dates, and then only do the complete longitudinal survey on the last date (and even then maybe not at all stations). When trying to determine food web dynamics, particular care must be taken not to deplete the stream of organisms during the addition. There will be taxa that cannot be sampled repeatedly at several sites without depletion. In these cases it is wise to consider carefully how many individuals are available and when they should best be sampled. The best strategy for collecting the optimum isotope tracer data will vary depending on the species. Predators that are rare put a premium on each individual taken. For these taxa, consider collecting reference samples from a similar reach of the same stream well away from the study site. These types of taxa reach their maximum del value (not always equilibrium) near the end of the isotope addition. If abundance of the organism permits, sample at a date that is about mid-way to the expected maximum and again at the maximum at two sites. This should give the most information from the fewest samples. If only one collection is possible, collect at the end of the  $^{15}\text{N}$  addition period. If only a very few individuals can be taken, consider running each specimen separately. The smallest sample feasible but expensive to run must contain 100 nM N (0.1  $\mu\text{M}$  or about 2  $\mu\text{g}$ ). One trick to assess trophic relationships is to pump out the stomachs of fish and other large animals and put them back. Fish stomachs often contain organisms that are difficult to collect and these can be run for isotopic content to fill out your food web diagram. Because predators and large omnivores are mobile, interpreting their isotopic tracer signals can be difficult. Knowledge of life history is important because many species have periods of movement and relatively stationary periods. Marking individuals just prior to the study is one way of determining how they might have moved during the experiment.



## REFERENCES

- [1] VITOUSEK, P.M., et al., Human alteration of the global nitrogen cycle: sources and consequences, *Ecol. Appl.* **7** (1997) 737–750.
- [2] INSTITUTO NACIONAL DE PESQUISAS ESPACIAIS, Deforestation in Brazilian Amazonia, São José dos Campos, São Paulo, Brazil (2007), <http://www.obt.inpe.br/prodes/index.html>.
- [3] MCCLAIN, M.E., ELSENBEER, H., “Terrestrial inputs to amazon streams and internal biogeochemical processing”, *The biogeochemistry of the Amazon basin* (MCCLAIN, M.E., VICTORIA, R.L., RICHEY, R.E., Eds), Oxford University Press. Oxford (2001) 185–208.
- [4] VANNOTE, R.L., MINSHALL, G.W., CUMMINS, K.W., SEDELL, J.R., CUSHING, C.E., The river continuum concept, *Can. J. Fish. Aquat. Sci.* **37** (1980) 130–137.
- [5] NAIMAN, R.J., MELILLO, J.M., LOCK, M.A., FORD, T.E., REICE, S.R., Longitudinal patterns of ecosystem processes and community structure in a subarctic river continuum, *Ecology* **68** (1987) 1139–1156.
- [6] PETERSON, B.J., et al., Control of nitrogen export from watersheds by headwater streams, *Science* **292** (2001) 86–90.
- [7] BORMANN, R.H., LIKENS, G.E., *Pattern and process in a forested ecosystem*. Springer-verlag, NY (1979).
- [8] WILLIAMS, M.R., MELACK, J.M., Solute export from forested and partially deforested catchments in the central Amazon, *Biogeochemistry* **38** (1997) 67–102.
- [9] NEILL, C., DEEGAN, L.A., THOMAS, S.M., CERRI, C.C., Deforestation for pasture alters nitrogen and phosphorus in small Amazonian streams, *Ecol. Appl.* **11** (2001) 1817–1828.
- [10] BIGGS, T.W., DUNNE, T., MARTINELLI, L.A., Natural controls and human impacts on stream nutrient concentrations in a deforested region of the Brazilian Amazon basin, *Biogeochemistry* **68** (2004) 227–257.
- [11] WOLLHEIM, W.M., et al., Influence of stream size on ammonium and suspended particulate nitrogen processing, *Limnol. Oceanogr.* **46** 1 (2001) 1–13.
- [12] MULHOLLAND, P.J., et al., Nitrogen cycling in a forest stream determined by a <sup>15</sup>N tracer addition, *Ecol. Monogr.* **70** (2000) 471–493.
- [13] JUNK, G., SVEC, H.J., The absolute abundance of the nitrogen isotopes in the atmosphere and compressed gases from various sources, *Geochim. Cosmochim. Acta* **14** 3 (1958) 234–243.
- [14] TANK, J. L., BERNOT, M.J., ROSI-MARSHALL, E.J., “Nitrogen limitation and uptake”, *Methods in stream ecology* (HAUER, F.R., LAMBERTI, G.A., Eds), Academic Press, Burlington, MA (2006) 213–238.
- [15] THOMAS, S.M., et al., Influences of land use and stream size on particulate and dissolved materials in a small Amazonian stream network, *Biogeochemistry* **68** (2004) 135–151.

- [16] BASTOS, T.X., DINIZ, T.D. DE A.S., Avaliação de clima do Estado de Rondônia para desenvolvimento agrícola, Boletim de pesquisa No. 44, Empresa Brasileira de Pesquisa Agropecuária, Centro de Pesquisa Agropecuária do Trópico Úmido (EMBRAPA-CPA-TU), Belém, Brazil (1982).
- [17] MORAES, J.F.L., VOLKOFF, B., BERNOUX, M., CERRI, C.C., Soil properties under Amazon forest and changes due to pasture installation in Rondônia (Brazil), *Geoderma* **70** (1996) 63–81.
- [18] MULHOLLAND, P.J., et al., Stream denitrification and total uptake rates measured using a field <sup>15</sup>N tracer addition approach, *Limnol. Oceanogr.* **49** (2004) 809–820.
- [19] HUGHES, J.E., DEEGAN, L.A., PETERSON, B.J., HOLMES, R.M., FRY, B., Nitrogen flow through the food web in the oligohaline zone of a New England estuary, *Ecology* **81** (2000) 433–452.
- [20] MULHOLLAND, P.J., et al., Nitrate removal in stream ecosystems measured by <sup>15</sup>N addition experiments: Denitrification. *Limnol. Oceanogr.* **54** 3 (2009) 666–680
- [21] HERSHEY, A.E., FORTINO, K., PETERSON, B.J., ULSETH, A., "Stream food webs", *Methods in Stream Ecology* (HAUE, F.H., LAMBERTI, G., Eds), Academic Press, NY, NY (2006) 637–659.
- [22] MULHOLLAND, P.J., et al., Stream denitrification across biomes and its response to anthropogenic nitrate loading, *Nature* **452** (2008) 202–205.
- [23] TANK, J.L., et al., Analysis of nitrogen cycling in a forest stream during autumn using a <sup>15</sup>N-tracer addition, *Limnol. Oceanogr.* **45** 5 (2000) 1013–1029.
- [24] HAUER, F.R., LAMBERTI, G.A. (Eds), *Methods in Stream Ecology*, 2nd edition, Academic Press, Burlington, MA (2006).

## BIBLIOGRAPHY

HOLMES, R.M., MCCLELLAND, J., SIGMAN, D.M., FRY, B., PETERSON, B.J., Measuring <sup>15</sup>N–NH<sub>4</sub> in marine, estuarine, and fresh waters: an adaptation of the ammonia diffusion method for samples with low ammonium concentrations, *Mar. Chem.* **60** (1998) 235–243.

SIGMAN, D.M., et al., Natural abundance-level measurement of nitrogen isotopic composition of oceanic nitrate: an adaptation of the ammonia diffusion method, *Mar. Chem.* **57** (1997) 227–242.

LINX web site, <http://www.faculty.biol.vt.edu/webster/linx>



# THE OXYGEN ISOTOPIC COMPOSITION OF PHOSPHATE: A TRACER FOR PHOSPHATE SOURCES AND CYCLING

K. McLAUGHLIN<sup>a</sup>, M.B. YOUNG<sup>b</sup>, A. PAYTAN<sup>b</sup>, C. KENDALL<sup>b</sup>

<sup>a</sup> Southern California Coastal Water Research Project,  
Costa Mesa, CA, USA

<sup>b</sup> U.S. Geological Survey,  
CA, USA

<sup>c</sup> University of California,  
Santa Cruz, CA, USA

## Abstract

Phosphorus (P) is a limiting macro-nutrient for primary productivity and anthropogenic P-loading to aquatic ecosystems is one of the leading causes of eutrophication in many ecosystems throughout the world. Because P has only one stable isotope, traditional isotope techniques are not possible for tracing sources and cycling of P in aquatic systems. However, much of the P in nature is bonded to four oxygen (O) atoms as orthophosphate ( $\text{PO}_4^{3-}$ ). The P–O bonds in orthophosphate are strongly resistant to inorganic hydrolysis and do not exchange oxygen with water without biological mediation (enzyme-mediated recycling). Thus, the oxygen isotopic composition of dissolved inorganic phosphate ( $\delta^{18}\text{O}_p$ ) may be used as a tracer for phosphate sources and cycling in aquatic ecosystems. Recently, several studies have been conducted utilizing  $\delta^{18}\text{O}_p$  as a tracer for phosphate sources and cycling in various aquatic environments. Specifically, work to date indicates that  $\delta^{18}\text{O}_p$  is useful for determining sources of phosphate to aquatic systems if these sources have unique isotopic signatures and phosphate cycling within the system is limited compared to input fluxes. In addition, because various processes imprint specific fractionation effects, the  $\delta^{18}\text{O}_p$  tracer can be utilized to determine the degree of phosphorous cycling and processing through the biomass. This chapter reviews several of these studies and discusses the potential to utilize the  $\delta^{18}\text{O}_p$  of phosphate in rivers and streams.

## 1. INTRODUCTION

Agricultural expansion is expected to be accompanied by a 2.4 to 2.7 fold increase in nitrogen (N)- and phosphorus (P)-driven eutrophication of terrestrial, freshwater and near shore marine environments [1]. Much of the N and P from fertilizers and animal waste enters surface waters and groundwater [2] and these nutrient loads can stimulate large scale macroalgal and/or phytoplankton blooms in receiving waters [3, 4]. Nutrient enrichment in aquatic systems can cause diverse problems such as harmful algal blooms, anoxia, fish kills, loss of habitat and biodiversity, as well as other problem [1, 2]. Thus, identifying and understanding nutrient inputs and their effects on aquatic ecosystems are of critical importance to management and restoration efforts.

Phosphorus is a required element for life; consequently, its availability may impact primary production rates as well as species distribution and ecosystem structure [5–7]. Phosphorus may limit primary productivity in some aquatic systems [8–10], and may be co-limiting in others [11, 12]. Because P has only one stable isotope, P natural abundance stable isotope ratios cannot be used for studies of nutrient sources, cycling and utilization (as is the case for nitrogen

and carbon). Radioactive P isotopes ( $^{32}\text{P}$ ,  $^{33}\text{P}$ ) have been used for investigation of P transformations in aquatic systems [13–15]; however, there are many complications involved with this procedure. The use of natural stable isotope signatures has advantages because this approach does not perturb the system (for example, by adding phosphate) and integrates processes over longer time scales. While P has only one stable isotope, P in most organic and inorganic P forms is strongly bonded to oxygen (O), which has three stable isotopes, providing a system to track phosphorus cycling and transformations using the stable isotopes of O in phosphate ( $\delta^{18}\text{O}_p$ ). The oxygen isotopic composition of phosphate is reported in standard delta notation ( $\delta^{18}\text{O}$ ) in per mil units (‰), and is calculated using the following equation:

$$\delta^{18}\text{O}(\text{‰}) = \left[ \frac{R_{\text{sample}}}{R_{\text{VSMOW}}} - 1 \right] \times 1000 \quad (1)$$

where  $R_{\text{sample}}$  is the ratio of  $^{18}\text{O}/^{16}\text{O}$  in a sample and  $R_{\text{VSMOW}}$  is the ratio of  $^{18}\text{O}/^{16}\text{O}$  in the isotopic standard for O, Vienna Standard Mean Ocean Water (VSMOW).

The P–O bond in phosphate is resistant to inorganic hydrolysis and, at the temperature and pH of most natural systems, phosphate does not exchange O with water without biological mediation [16–18]. Thus, observed variability in the  $\delta^{18}\text{O}_p$  will reflect mixing of isotopically distinct sources of phosphate, the alteration of the phosphate  $\delta^{18}\text{O}$  as the result of O exchange during cycling of phosphate, or a combination of these processes. In the latter case, isotope fractionations associated with reactions and transformations operating in the P cycle have been determined in controlled laboratory experiments (Table 1) and this information provides the basis for interpretation of isotope data ( $\delta^{18}\text{O}_p$ ) obtained from phosphate in the natural environment.

In the absence of biological activity at ambient temperatures, pH, and pressure, isotope exchange between phosphate oxygen and water (or other solutions) is slow and can be considered negligible for the time scales of concern of most environmental applications [16, 18–20]. The expected equilibrium  $\delta^{18}\text{O}_p$  for precipitation of mineral phosphate (apatite) from water can be calculated from the temperature and the  $\delta^{18}\text{O}$  of the environmental water ( $\delta^{18}\text{O}_w$ ) using the empirically derived fractionation equation between phosphate and water developed by [19]:

$$T(^{\circ}\text{C}) = 111.4 - 4.3 (\delta^{18}\text{O}_p - \delta^{18}\text{O}_w) \quad (2)$$

where  $T$  is the environmental temperature,  $\delta^{18}\text{O}_p$  is the isotopic composition of the phosphate, and  $\delta^{18}\text{O}_w$  is the isotopic composition of the environmental water.

Studies of precipitation and dissolution of various P bearing minerals and studies of P adsorption and desorption onto/from mineral surfaces indicate that the fractionation associated with these processes (given equilibration time of more than a few hours) is small — in the range of 1‰ [21–23]. Typically the heavier isotopes in these reactions are associated with the mineral phase while the solution retains phosphate with lighter isotopes. Precipitation or dissolution of apatite minerals (inorganically) will be accompanied by a small oxygen isotope fractionation in the range of +0.7‰ to +1‰ [20]. Similarly, adsorption or precipitation with sesquioxides and hydroxides imprints a small positive isotope effect [23].

In contrast to inorganic reactions, enzyme mediated biological activity can break the P–O bond in processes that involve large isotopic fractionation. Intracellular as well as extracellular en-

TABLE 1. ISOTOPIC FRACTIONATION EFFECTS ASSOCIATED WITH VARIOUS BIOGEOCHEMICAL PROCESSES

Process	Fractionation ( $\Delta$ or $\epsilon$ )	Reference
Precipitation/dissolution of P minerals (apatite)	+0.7‰ to +1‰ heavy isotope in mineral phase	[17]
Adsorption/desorption of P to/from mineral surfaces	$\sim$ +1‰ heavy isotope in mineral phase	[22]
Precipitation with sesquioxides and hydroxides	$\sim$ +1‰ heavy isotope in mineral phase	[23]
Abiotic hydrolysis of polyphosphate (O:P = 3.33), pyrophosphate (O:P = 3.5), phosphonates (O:P = 3.0), monoesters (O:P = 3.0) and diesters (O:P = 2.0)	No fractionation or temperature effect, however incorporation of oxygen from water during formation of PO <sub>4</sub> (O:P = 4) occurs	[24]
Transport by water or air	No fractionation or temperature effect	[25]
Assimilation by phytoplankton	Light isotopes preferentially utilized, enrichment of the residual solution ( $\epsilon = -3\text{‰}$ )	[25]
Intracellular processing such as inorganic pyrophosphatase (PPase) catalysis	Equilibrium isotopic exchange T and $\delta^{18}\text{O}_w$ impact (equation 3)	[25]
Alkaline phosphatase (APase) hydrolyzation of phosphomonoesterase (extracellular) kinetic isotope effects	$\epsilon = -30\text{‰}$ effecting only the newly incorporated oxygen	[27]
5'-nucleotidase hydrolyzation (extracellular) kinetic isotope effects	$\epsilon = -10\text{‰}$ effecting only the newly incorporated oxygen	[27]
First step of DNase hydrolyzation kinetic isotope effects	$\epsilon = -20\text{‰}$ effecting only the newly incorporated oxygen	[27]
First step of RNase hydrolyzation kinetic isotope effects	$\epsilon = +20\text{‰}$ effecting only the newly incorporated oxygen	[27]

zymes are expressed by various organisms for the uptake and utilization of P and may play a role in determining the oxygen isotopic composition of phosphate in aquatic systems. Different enzymatic processes induce different isotopic fractionations (Table 1). The dominant enzymatic process controlling  $\delta^{18}\text{O}_p$  in the environment is the intracellular activity of pyrophosphatase (PPase) [26], which involves equilibrium isotopic exchange. Blake et al. [26] found that this enzymatic activity results in isotopic equilibrium of oxygen in phosphate similar to that described in Ref. [19]. The equation for phosphate extracted from microbial cultures was described in Ref. [20]:

$$T(^{\circ}\text{C}) = 155.8 - 6.4 (\delta^{18}\text{O}_p - \delta^{18}\text{O}_w) \quad (3)$$

These equilibrium relations have been observed in the tissues of a variety of organisms, including fish, mammals [28], bacteria and algae [17, 29, 26]. Results of an algae culture experiment indicate that intracellular oxygen isotope exchange between phosphorus compounds and water



is very rapid [29]. These processes are expected to occur in aquatic systems by all organisms and release of this phosphate from cells to the environment will impact dissolved phosphate  $\delta^{18}\text{O}_p$ . Extracellular remineralization and hydrolyzation of organic P ( $\text{P}_o$ ) compounds by phosphohydrolase enzymes such as alkaline phosphatase (APase) and 5'-nucleotidase, involves incorporation of one or more oxygen atoms from the ambient water with an isotope fractionation of  $-30\text{‰}$  and  $-10\text{‰}$ , respectively [27]. The resulting phosphate from such processes will reflect this fractionation and would typically shift  $\delta^{18}\text{O}_p$  towards values that are lower than equilibrium. Work by several groups is currently ongoing to determine the isotope fractionation associated with additional enzymes, and will enable better interpretation of field data. Uptake and utilization (assimilation) of phosphate by aquatic plants, algae, and microorganisms is also associated with isotope fractionation. The phosphate with lighter O isotopes is preferentially utilized, a process that could enrich the residual solution with phosphate that has heavy O isotopes [26].

Oxygen isotope tracer studies of dissolved phosphate and particulate phosphate in natural environments are limited. However, recent field studies have demonstrated the utility of  $\delta^{18}\text{O}_p$  of DIP as a tracer for the mixing of phosphate sources in lakes, estuaries and the coastal ocean ecosystems [30–33] and for tracing phosphate sources in sediments and soils in an estuarine watershed [24]. These applications are based on the assumption that extensive recycling and turnover will lead to isotopic equilibrium while deviation from equilibrium may reflect source signatures or other processes that do not result in isotopic equilibrium, such as expression of extracellular enzymes or phosphate uptake. Furthermore, other studies have suggested that different sources may be isotopically distinct [34, 35].

## **2. METHOD FOR ASSESSING THE OXYGEN ISOTOPIC COMPOSITION OF PHOSPHATE**

The oxygen isotopic composition of phosphate can be measured in both dissolved and particulate phases. McLaughlin et al. [36] outlines the protocol for extraction of dissolved inorganic phosphate from water samples for isotopic analysis. McLaughlin et al. [37] presents a method for isotopic analysis of phosphate oxygen in particulate inorganic and organic matter samples. Each of these methods is described briefly below. Other methods [16, 25, 26, 28, 38–42] which are slightly different than those discussed below have also been published.

### **2.1. Dissolved inorganic phosphate**

Water samples are collected in acid washed high density polyethylene bottles and filtered through  $0.45\ \mu\text{m}$  filters to remove particulates. The amount of water required for each sample depends on the dissolved inorganic phosphate (DIP) concentration, and typically ranges from 1 L for waste water treatment plant effluent to more than 40 L for some lakes and oligotrophic areas of the ocean. For low salinity samples, magnesium chloride (ACS grade, with low phosphate content) is added as needed to raise the magnesium content to that of seawater. Samples are then processed through an extraction and purification protocol according to McLaughlin et al. [36]. Phosphate is initially co-precipitated with magnesium hydroxide, the pellet collected and subsequently dissolved in nitric acid. This step reduces the volume of the sample. Cerium phosphate is then precipitated from the solution in order to separate phosphate from competing anions. This precipitate is washed and centrifuged several times, before being dissolved in a small amount of 4 M nitric acid. The solution is passed through a cation exchange resin to

remove the cerium ions (to prevent interference during the final precipitation), and phosphate is ultimately precipitated as silver phosphate for isotope ratio analysis. The silver phosphate is thermally decomposed in the presence of carbon to form carbon monoxide, which is then analysed by isotope ratio mass spectrometry (IR–MS) for masses 28, 29 and 30. Results are calibrated and precision monitored using internal standards with known isotopic composition. All oxygen isotopic measurements are reported in the standard delta notation in per mil units (‰) with respect to Vienna Standard Mean Ocean Water (VSMOW); the precision of  $\delta^{18}\text{O}_p$  is approximately  $\pm 0.3\text{‰}$ . Currently no international silver phosphate reference standards exist for phosphate oxygen isotopic analysis and most laboratories use internal standards.

Problems with the precipitation of cerium phosphate and silver phosphate have been experienced when working with water samples containing very high concentrations of dissolved organic matter. Several promising approaches for addressing this problem have been explored, including UV radiation of the water sample [43], passing the sample through phosphate free activated carbon [34], and the use of resins (such as DAX–8) to remove organics while leaving the DIP in solution [44]. Treatment of the silver phosphate with 15%  $\text{H}_2\text{O}_2$  at room temperature was also suggested [45].

## 2.2. Particulate phosphate

Particulate phosphatic compounds must be converted to silver phosphate prior to isotopic analysis, a process that involves digestion of particulate matter in acid. This digestion will hydrolyze some of the phosphatic compounds such that oxygen from the acid solution could be incorporated into the sample as these phosphatic compounds are converted to orthophosphate ( $\text{PO}_4^{3-}$ ). As described in Ref. [37], duplicate samples of particulate organic matter samples (periphyton, sediment, soils, plant material, etc.) are weighed into separate 50 ml polyethylene depressed cap centrifuge tubes. Ten millilitres of 10 M nitric acid is added to one of these and ten millilitres of 10 M nitric acid that had been amended with  $\text{H}_2^{18}\text{O}$  (Isotec T88–70022 batch # EQ0820) is added to the remaining sample. All samples are then heated on a hot plate held at 50 °C. The acid is neutralized with 8 M potassium hydroxide (Fisher Scientific, ACS grade) and the solution is then buffered with 1 M potassium acetate (Fisher Scientific, ACS grade). Purified silver phosphate is ultimately precipitated and analysed for  $\delta^{18}\text{O}_p$  according to McLaughlin et al. [36] or other published procedures. Results from this study indicate that there is no isotopic fractionation associated with acid digestion at 50°C and that reagent oxygen incorporation is a function of the oxygen to phosphorus ratio (O:P) of the digested compound whereby the percentage of reagent oxygen incorporated into the sample is the same as that which is required to convert all of the P-compounds into orthophosphate [37]. Thus, the isotopic composition of organic matter samples can be calculated by solving a system of mass balance equations, one for the spiked reagent and one for the unspiked:

$$\begin{aligned}\delta^{18}\text{O}_{\text{spiked measured}} &= X \delta^{18}\text{O}_{\text{sample}} + (1-X) \delta^{18}\text{O}_{\text{spiked reagent}} \\ \delta^{18}\text{O}_{\text{unspiked measured}} &= X \delta^{18}\text{O}_{\text{sample}} + (1-X) \delta^{18}\text{O}_{\text{unspiked reagent}}\end{aligned}\quad (4)$$

where  $X$  is the proportion of oxygen from the sample,  $(1-X)$  is the proportion of oxygen from the reagent,  $\delta^{18}\text{O}_{\text{spiked reagent}}$  is the isotopic composition of the  $^{18}\text{O}$  amended acid,  $\delta^{18}\text{O}_{\text{unspiked reagent}}$  is the isotopic composition of the unspiked acid solution,  $\delta^{18}\text{O}_{\text{sample}}$  is the ‘true’ isotopic composition for the sample,  $\delta^{18}\text{O}_{\text{spiked measured}}$  is the oxygen isotopic composition of the sample measured after digestion of the sample in the spiked nitric acid reagent, and  $\delta^{18}\text{O}_{\text{unspiked measured}}$

is the isotopic composition of the sample after digestion in the unspiked nitric acid reagent. Solving these two equations for the  $\delta^{18}\text{O}_{\text{sample}}$  yields:

$$\delta^{18}\text{O}_{\text{sample}} = \frac{(\delta^{18}\text{O}_{\text{spiked reagent}} \times \delta^{18}\text{O}_{\text{unspiked measured}}) - (\delta^{18}\text{O}_{\text{spiked measured}} \times \delta^{18}\text{O}_{\text{unspiked reagent}})}{(\delta^{18}\text{O}_{\text{unspiked measured}} - \delta^{18}\text{O}_{\text{spiked measured}} + \delta^{18}\text{O}_{\text{spiked reagent}} - \delta^{18}\text{O}_{\text{unspiked reagent}})} \quad (5)$$

### 3. END-MEMBER VALUES FOR PHOSPHATE SOURCES

Identifying point and non-point nutrient sources is critical to understanding ecosystem health, and has important implications for management practices, including industry regulation and allocation of funding and research efforts. P sources can be separated into point sources, such as sewage discharge sites, and non-point sources like soil leaching and agricultural run-off. One of the most significant limitations for the application of this tracer is that very little data exists regarding the  $\delta^{18}\text{O}_p$  of various natural and anthropogenic phosphate sources. Recent research has shown that the  $\delta^{18}\text{O}_p$  of various primary anthropogenic phosphate sources to aquatic ecosystems spans a wide range of  $\delta^{18}\text{O}_p$  values, indicating that this can be a useful tool for distinguishing phosphate sources in certain systems.

Young et al. [35] analysed an initial set of potential P sources for  $\delta^{18}\text{O}_p$ , including wastewater treatment plant effluent, chemical and organic fertilizers, semi-processed phosphorite ore (used to make chemical fertilizers), dish washing detergents, toothpaste, soil leachates, and aerosol (dust) samples (Fig. 1). A considerable range of  $\delta^{18}\text{O}_p$  values was measured in the various P sources (samples ranged from 6 to 27‰), and the differences were much larger than the analytical precision ( $\pm 0.3\%$ ) associated with this technique. Although there is considerable overlap in  $\delta^{18}\text{O}_p$  measured in the various groups of samples, these results indicate that in specific geographic regions, different P source types may span a narrower range and have distinct signatures. In these cases, the  $\delta^{18}\text{O}_p$  could be useful for identifying the contribution of the different sources. For example, while the entire range of reported  $\delta^{18}\text{O}_p$  values for wastewater treatment plant (WTP) effluent (3 WTPs; France, Connecticut, California) overlaps with the values measured for multiple types of detergents, organic fertilizers, and chemical fertilizers, all  $\delta^{18}\text{O}_p$  values for the Palo Alto Regional Water Quality Control Plant were significantly lower than any of the measured fertilizers and detergents [35]. Thus, if phosphate is not heavily cycled within an ecosystem, such that the source signature is reset,  $\delta^{18}\text{O}_p$  can be used to identify isotopically distinct phosphate sources and/or the extent of phosphate cycling in aquatic systems (such as the deviation from the isotopic composition of the source from the expected equilibrium value).

Wastewater treatment effluent is a significant source of phosphate in many areas, and studies are currently underway looking at how the  $\delta^{18}\text{O}_p$  of wastewater treatment plant effluent changes over time and throughout treatment processes. It is currently not known if the  $\delta^{18}\text{O}_p$  of wastewater treatment plant effluent is a reflection of the P source signature, biological equilibration with the  $^{18}\text{O}_w$  of water within the sewer system and/or treatment plant, or a combination of both. Samples were collected at each stage of treatment at the Palo Alto Water Quality Control Plant, and no significant differences were found throughout the treatment cycle, indicating that the particular treatment processes used at this plant does not change the  $\delta^{18}\text{O}_p$  signature. However, there was a significant change in the  $\delta^{18}\text{O}_p$  of the effluent between October 2005 and January 2006, which also corresponded to a similar change in the  $^{18}\text{O}_w$  of the incoming water. It is likely that the  $\delta^{18}\text{O}_p$  of the effluent is controlled by a combination of  $\delta^{18}\text{O}_p$  sources and

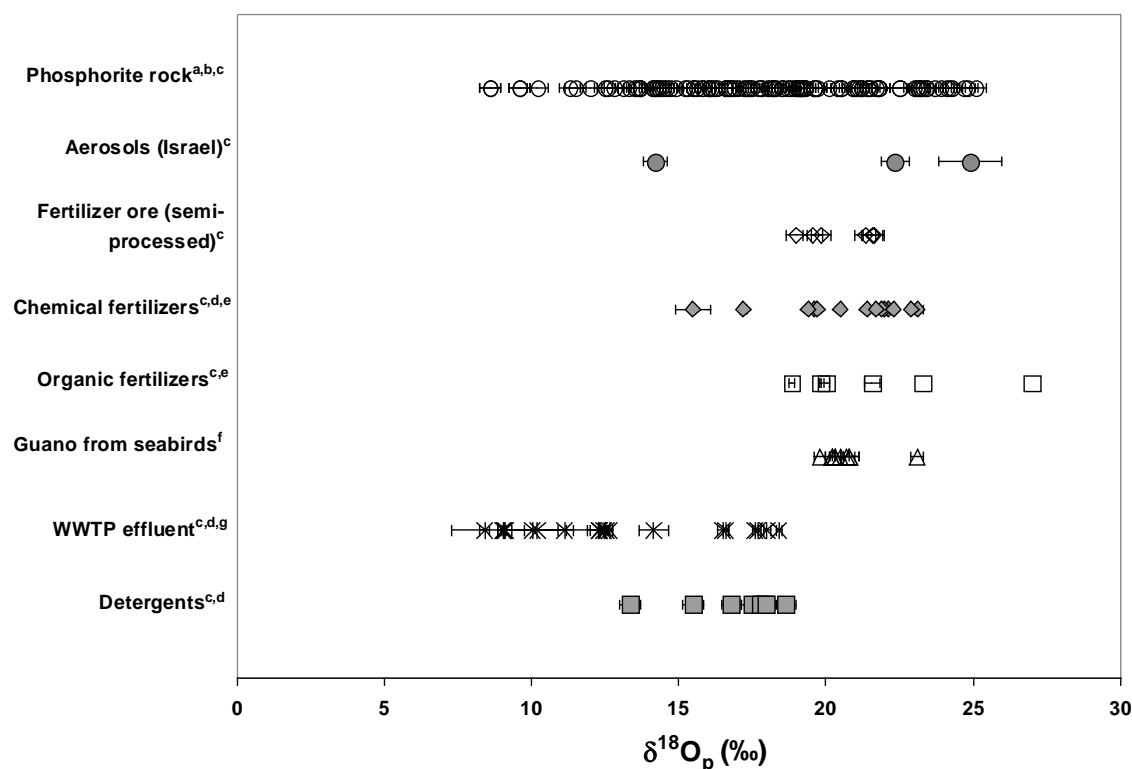

FIG. 1. Range of potential end-member values for natural and anthropogenic phosphate sources to aquatic systems.

biological equilibration prior to entering the treatment plant, but more sampling is required in order to understand these processes and potential variations, depending on treatment types and plant locations.

#### 4. PHOSPHATE SOURCES AND CYCLING IN ESTUARINE AND COASTAL ENVIRONMENTS

To date, there are relatively few studies assessing the oxygen isotopic composition of DIP in natural aquatic systems. Pioneering work by Longinelli et al. [16] found no variation in the  $\delta^{18}\text{O}_p$  of DIP in seawater or of marine organism soft tissue with either depth or latitude in the Atlantic and Pacific Oceans, although there was a significant difference between the two ocean basins. The  $\delta^{18}\text{O}_p$  values were thought to reflect kinetic-biological isotopic fractionation. However, Longinelli et al. [16] extracted P from seawater without pre-filtration and used Fe-coated fibres, which absorb both inorganic and organic P and such complications may confound interpretation of their results. More recently, Colman [30] concluded that the large deviations in  $\delta^{18}\text{O}_p$  between riverine and coastal waters in the Long Island Sound reflected equilibration with local water and indicated that rapid microbial cycling overprints source  $\delta^{18}\text{O}_p$  values on a timescale of weeks. In contrast, phosphate in the San Francisco Bay estuary is typically not equilibrated with environmental water and reflects two end-members mixing between oceanic phosphate and riverine phosphate with seasonally important additional inputs along this flow path [32]. In California coastal waters (Monterey Bay), phosphate oxygen isotope ratios tracked seasonal changes in phosphate cycling through the biomass (for example, phos-

phate utilization rates) with the greatest phosphate oxygen isotope exchange occurring during the upwelling season [31]. The  $\delta^{18}\text{O}_p$  in open ocean waters is a function of DIP transport and biological turnover in both the Atlantic and the Pacific Oceans and highlights the importance of cell lysis in the regeneration of DIP in the euphotic zone [46]. Furthermore, at depth,  $\delta^{18}\text{O}_p$  values are near temperature dependent equilibrium, suggestive of bacterial turnover of DIP in seawater [46]. These data indicate that the  $\delta^{18}\text{O}_p$  can be used as a powerful tool for identifying and quantifying the contribution of non-point sources of phosphate pollution into some aquatic systems and that it could be used to determine relative rates of P cycling and utilization in marine systems.

The next few sections briefly discuss the utilization of the oxygen isotopic composition of phosphate as a tool for identifying phosphate sources and cycling in estuarine environments and describe the potential of expanding usage into riverine environments.

#### 4.1. San Francisco Bay, California, USA: Use of $\delta^{18}\text{O}$ of dissolved inorganic phosphate as a tracer for phosphate sources

In a study of North San Francisco Bay, McLaughlin et al. [32] used  $\delta^{18}\text{O}_p$  to assess mixing of dissolved inorganic phosphate (DIP) sources along an estuarine flowpath. The  $\delta^{18}\text{O}$  of DIP ( $\delta^{18}\text{O}_p$ ) will largely be determined by the isotopic composition ( $\delta^{18}\text{O}_w$ ) and temperature of the water. Because the  $\delta^{18}\text{O}_w$  of water in rivers and oceans is significantly different, the  $\delta^{18}\text{O}$  of phosphate recycled in these waters will also be different as a result of equilibrium fractionation. Thus, phosphate  $\delta^{18}\text{O}_p$  may be used to either characterize mixing between oceanic and riverine

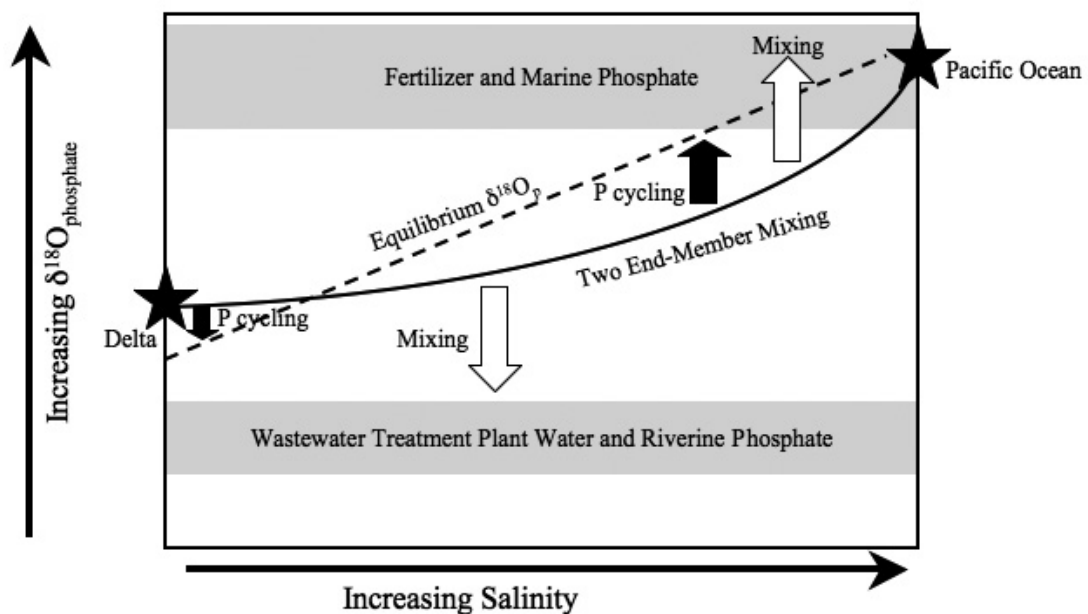

FIG. 2. Diagram indicating two end-member mixing and the expected equilibrium mixing line. Deviations below both the two end-member mixing (white down facing arrow) indicate mixing with either a riverine or wastewater treatment plant effluent. Deviations which move off the two end-member mixing line in the direction of equilibrium mixing may be indicative of phosphate cycling, though they may also represent mixing with fertilizer phosphate. Deviations which fall off the two-end member mixing line in the direction of equilibrium, but in excess of equilibrium are indicative of mixing with fertilizer phosphate or treatment plant effluent, depending on where along the salinity gradient the deviation occurs.

phosphate or to determine the extent of phosphate cycling. North San Francisco Bay can be characterized by a two end-member mixing model between Pacific Ocean waters and the freshwaters of the San Joaquin and Sacramento Rivers based on salinity and  $\delta^{18}\text{O}_w$  [32–47]. This mixing model can be adapted to represent an expected mixing line for  $\delta^{18}\text{O}_p$ , and the expected equilibrium value at each site can be calculated (Figs 2 and 3). Deviations from the  $\delta^{18}\text{O}_p$  mixing line that are not consistent with equilibrium are most likely the result of the contribution

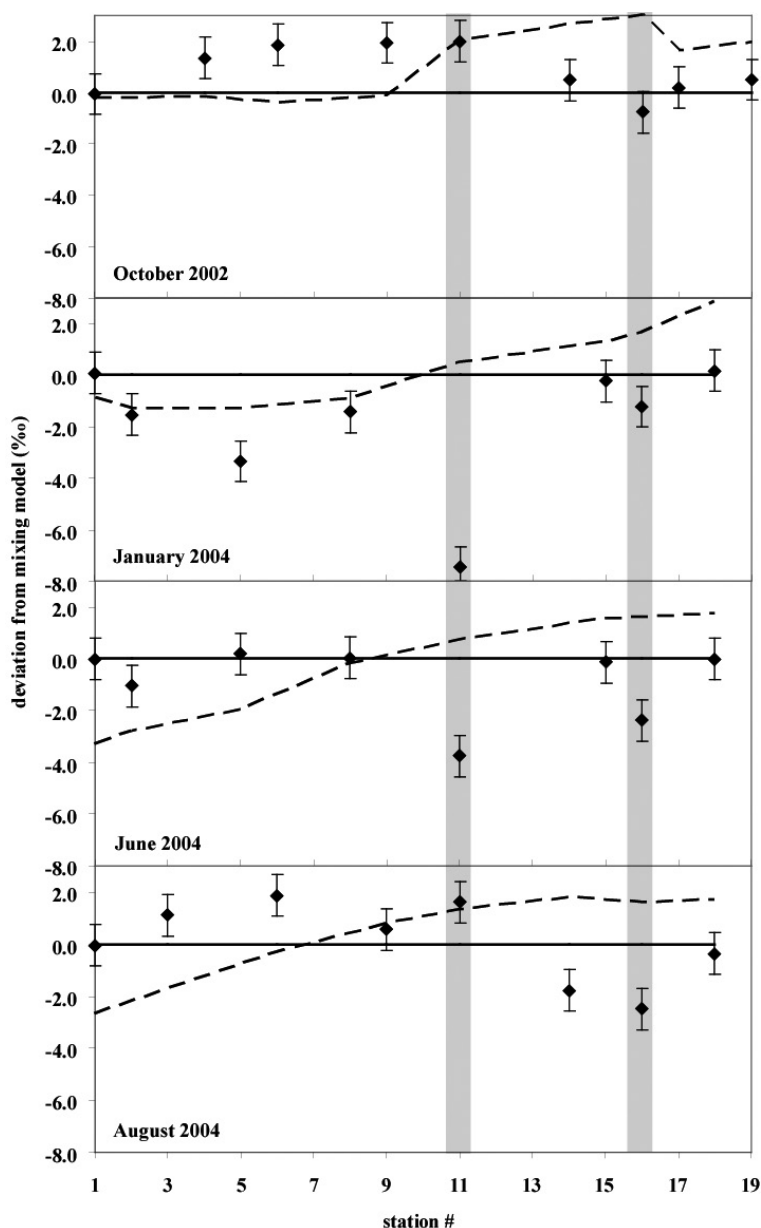

FIG. 3.  $\delta^{18}\text{O}_p$  deviations from those expected of two end-member mixing models (solid line) for each station and month sampled. Deviations from the mixing line were calculated by taking the difference between the expected  $\delta^{18}\text{O}_p$  calculated for each salinity and the measured  $\delta^{18}\text{O}_p$ . Deviations of the equilibrium  $\delta^{18}\text{O}_p$  from the two end-member mixing models are represented by the dashed line. The mixing model value in each of the above plots is represented by 0‰. Vertical highlighting shows the largest deviations observed at Station 11 in January 2004 and June 2004 and the most persistent deviations at Station 16 in all months. Error bars indicate the error propagated through the mixing models.



of phosphate with unique  $\delta^{18}\text{O}_p$  signatures at various point and non-point locations, such as the discharge points of tributaries (e.g. the Napa River) and wastewater treatment plants.

The general lack of isotopic equilibrium in the DIP throughout the Bay indicates that phosphate cycling is not rapid compared to phosphate input (low utilization rate, short residence time), and that source phosphate  $\delta^{18}\text{O}$  contributes to the observed  $\delta^{18}\text{O}_p$  at most, if not all, stations. The deviations from the  $\delta^{18}\text{O}_p$  mixing model represent inputs of phosphate from local phosphate sources within the North Bay (Fig. 3). In this study, we demonstrated that it is possible to use  $\delta^{18}\text{O}_p$  to identify point and non-point source phosphate inputs to aquatic systems and suggest that this may be applied in other impacted systems to identify specific anthropogenic sources, such as fertilizer and sewage phosphate, or natural sources of phosphate. This information is crucial for mitigation of pollution impacts and successful restoration of estuaries and other aquatic systems.

#### **4.2. Carneros Creek Watershed, California, USA: Use of $\delta^{18}\text{O}$ of particulate phosphate as a tracer for phosphate sources**

The Carneros Creek watershed drains into Elkhorn Slough, a small seasonal estuary in central California. This watershed has been subjected to increased nutrient loading from agricultural and other non-point sources. However, because nutrients do not behave conservatively and multiple sources may be present, tracing nutrient sources and the relative contribution of those sources in ecosystems like Elkhorn Slough and the Carneros Creek Watershed has been difficult to do using nutrient concentrations alone. Because of the high concentrations of phosphate within the watershed, P-demand is low relative to input and phosphate may not be heavily cycled within the ecosystem. Thus, the  $\delta^{18}\text{O}$  of phosphate will reflect the isotopic composition of phosphate sources to the system. McLaughlin et al. [24] utilized the  $\delta^{18}\text{O}$  of reactive phosphate from water, sediment, and soil samples collected within the watershed to understand phosphate sources and cycling.

The variability in  $\delta^{18}\text{O}_p$  observed in soils collected throughout the watershed and in sediments from Carneros Creek was indicative of the wide range of land uses and soil types in the watershed. Soil samples had higher total and reactive P concentrations than Carneros Creek sediments. However, both the creek sediments and soil samples spanned the same range of  $\delta^{18}\text{O}_p$ , which indicates that P sources to the creek sediments and to the soils originated from sources with similar isotopic signatures, most likely fertilizers. Samples from a single farm within the watershed (compost, soil and sediment pond samples) provided an example of how phosphate oxygen isotopes may be fractionated within a system. The  $\delta^{18}\text{O}_p$  of reactive phosphate extracted from the compost was low (18.8‰) relative to the  $\delta^{18}\text{O}_p$  of the nitric-acid-extractable phosphate of that compost (23.3‰), implying that phosphate with low  $\delta^{18}\text{O}_p$  is more readily mobilized. Furthermore, the  $\delta^{18}\text{O}_p$  of reactive phosphate in the compost (18.8‰) was higher than the farm soil sample (17.7‰), which in turn was higher than the sediment pond (15.5‰). Thus, low  $\delta^{18}\text{O}_p$  phosphate was preferentially moved from the compost to the soils and from there into the sediment pond. This was the first time that such an isotope effect has been reported and this observation should be confirmed with more data from other sites.

Sediment samples from within Carneros Creek bed indicated the prevalence of fertilizer use within the watershed: all samples analysed had high  $\delta^{18}\text{O}_p$  values (18.5‰, 22.5‰, 21.6‰), similar to the fertilizers measured. In all cases, the  $\delta^{18}\text{O}_p$  of creek sediments was higher than that of soils sampled nearby, suggesting that most of the phosphate in the creek water and sedi-

ments came directly from the fertilizer rather than through leaching of phosphate from soils. Alternatively, the  $\delta^{18}\text{O}_p$  of creek sediments could have a higher isotopic signature than the soil P due to preferential removal of low  $\delta^{18}\text{O}_p$  phosphate from the sediment into creek waters. Indeed, creek water sampled in the lower reaches of the creek had considerably lower  $\delta^{18}\text{O}_p$  values than sediment samples upstream. The variability observed within this limited set of samples was very promising and indicates that  $\delta^{18}\text{O}_p$  could be a powerful tool for identifying non-point source P pollution in watersheds and aquatic systems.

## 5. PHOSPHATE SOURCES AND CYCLING IN FRESHWATER SYSTEMS

The range of potential  $\delta^{18}\text{O}_p$  values for DIP in lakes and rivers is much greater than the range expected for open ocean and coastal waters due to the wider range of temperatures,  $\delta^{18}\text{O}$  water values, and phosphate sources found in riverine systems. Furthermore, land use patterns are thought to have a significant impact on nutrient stoichiometry and concentrations in freshwater environments [48–50], thus, differences in land use could provide unique  $\delta^{18}\text{O}_p$  signatures with which to trace the relative influence of specific sources to receiving waters. However, research on  $\delta^{18}\text{O}_p$  in freshwater systems is relatively sparse, and measured  $\delta^{18}\text{O}_p$  values are only available for a few locations. Many rivers may have phosphate inputs that are different from those found in open ocean or near shore environments. Common phosphate sources for rivers include wastewater treatment effluent, agricultural and urban runoff, manure, leaking septic systems, and natural rock and soil weathering. In addition, river discharge can be viewed as a source of phosphate in relation to other systems; for example, tributaries entering larger rivers, lakes, estuaries, or coastal waters. Although the  $\delta^{18}\text{O}_p$  of river water is usually controlled by a complex combination of source inputs and biogeochemical cycling, if the  $\delta^{18}\text{O}_p$  of the discharging water is known, it can be used to trace river phosphate as it enters a different environment or moves down a river's flow path.

Use of the oxygen isotopic composition of phosphate as a tracer for biological cycling within a river system is complicated by several factors (Fig. 4). Phosphorus bioavailability in lakes, rivers, and streams can be altered by adsorption and desorption onto fluvial suspended particles

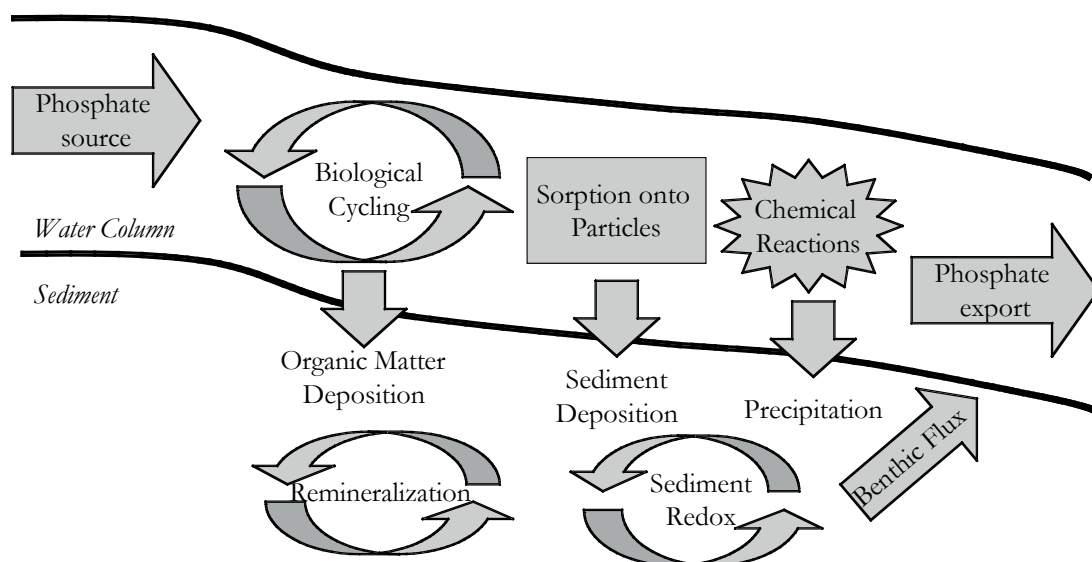

FIG. 4. Factors potentially affecting the  $\delta^{18}\text{O}_p$  in riverine environments.

[51], formation of colloidal compounds with ferric hydroxides [52], and co-precipitation with minerals such as calcite [53]. At this stage it is not known whether adsorption or co-precipitation will result in an isotopic fractionation although such an effect is expected to be small. Phosphate can be deposited in sediments and may eventually be effluxed from sediments at a later date [52, 54]. Thus, measurements of  $\delta^{18}\text{O}_p$  will reflect a combination of source signatures, enzyme mediated biological cycling, and physio-chemical reactions, each of which may impart an isotopic fractionation. Furthermore, these isotopic fractionations are not well understood in freshwater environments and more research is needed to fully characterize them.

### 5.1. San Joaquin River, California, USA

Water samples were collected from the San Joaquin River (SJR), a hypereutrophic river in the major agricultural region of the California Central Valley, in order to assess whether or not the  $\delta^{18}\text{O}_p$  of the DIP was in isotopic equilibrium with the river water and if measurable differences in  $\delta^{18}\text{O}_p$  existed throughout the river, tributaries, and drains [35]. Samples were collected at seven sites along the main stem of the SJR, and from nine separate drains and tributaries. Several of the same sites were sampled one week apart in order to see if short term changes could also be detected.

The range of  $\delta^{18}\text{O}_p$  measured in the SJR and tributaries was much larger than analytical error, and only one of the samples fell along the expected equilibrium line. Interestingly, the samples did not show any consistent offset from equilibrium, further indicating that the  $\delta^{18}\text{O}_p$  at least partially reflected inputs of phosphate sources with different  $\delta^{18}\text{O}_p$  signatures, rather than full biological cycling and complete oxygen exchange with water (Fig. 5). The highest  $\delta^{18}\text{O}_p$  values were measured at several sites that drain large wetland areas upstream of the lower San Joaquin River, while the lowest values were measured in the Merced River and in Harding Drain. This data set is preliminary and is just documented here to show the potential for using phosphate  $\delta^{18}\text{O}_p$  to assess distinct sources in freshwater systems. Further research is required to fully interpret this data set.

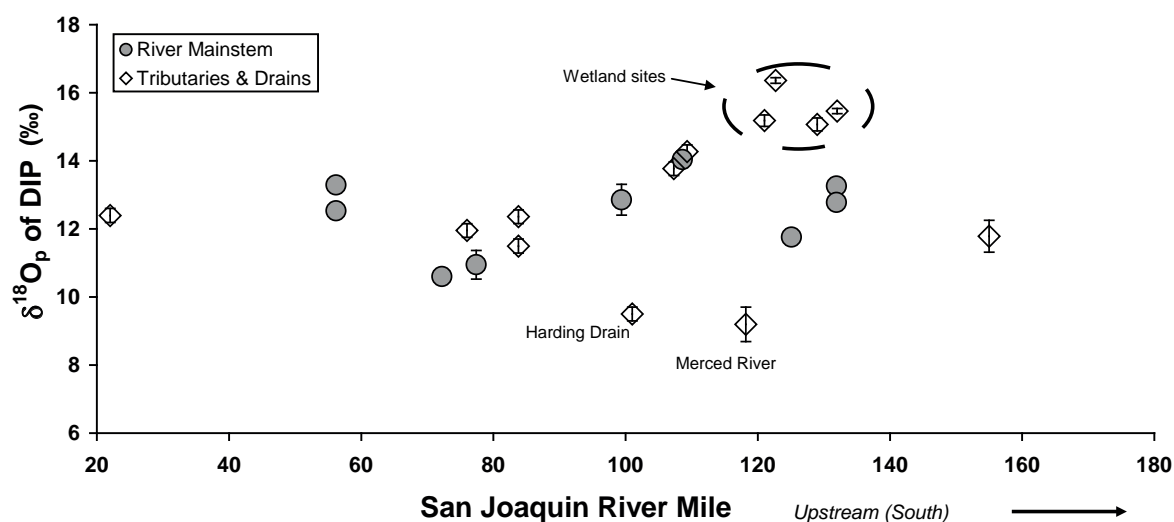

FIG. 5. The  $\delta^{18}\text{O}_p$  of dissolved inorganic phosphate in the San Joaquin River and tributaries as a tracer for phosphate sources.

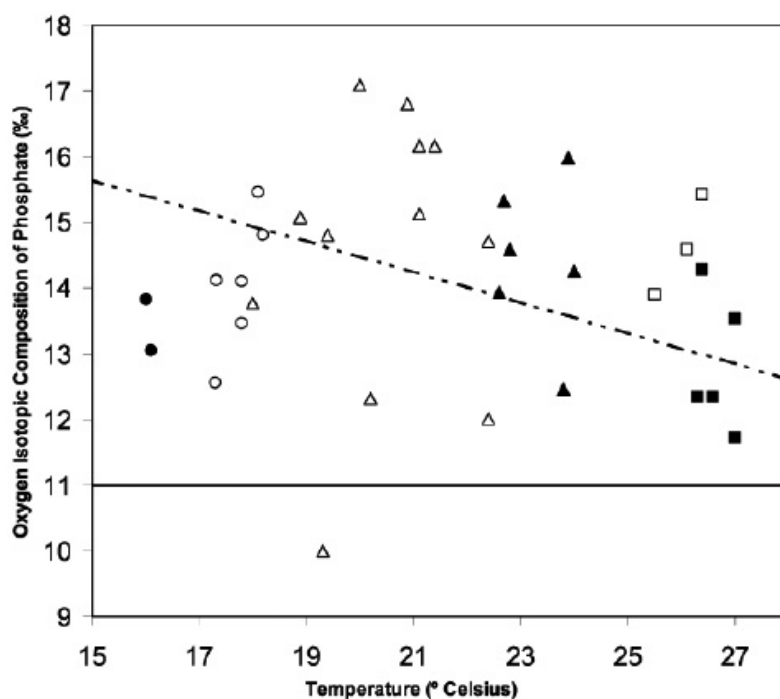

FIG. 6. Oxygen isotopic composition of phosphate ( $\delta^{18}O_p$ ) of Lake Erie surface water. Symbols refer to different sampling trips. The line at +11‰ represents the weighted average riverine  $\delta^{18}O_p$ . The dashed line represents the expected  $\delta^{18}O_p$  value calculated based on the temperature for each sample and at the average lake surface  $\delta^{18}O_w$  of  $-6.78\text{‰}$  (standard deviation  $0.3\text{‰}$ ). Samples plotting between the river and equilibrium lines could be explained by P cycling, a process that would tend to erase source signature and bring  $\delta^{18}O_p$  values towards equilibrium. Lines above the equilibrium line suggest a source with  $\delta^{18}O_p$  higher than  $17\text{‰}$ .

## 5.2. Lake Erie, USA

Elsbury et al. [55] recorded the distribution of  $\delta^{18}O_p$  in water samples from the western and central basins of Lake Erie along with several potential sources (rivers, waste water treatment plants, atmospheric deposition). The  $\delta^{18}O_p$  of lake water was largely out of equilibrium with ambient conditions, indicating that source signatures may be discerned. The  $\delta^{18}O_p$  values in the lake ranged from  $+10\text{‰}$  to  $+17\text{‰}$ , whereas equilibrium value was expected to be around  $+14\text{‰}$  and riverine weighted average  $\delta^{18}O_p$  value was  $+11\text{‰}$  (Fig. 6). It was concluded that some of the lake  $\delta^{18}O_p$  values could not be explained by any known source or process. This indicated that there must be one or more as yet uncharacterized source(s) of phosphate with a high  $\delta^{18}O_p$  value. In this study, the authors speculate that a likely source may be the release of phosphate from sediments under reducing conditions created during anoxic events in the hypolimnion of the central basin of Lake Erie.

## 5.3. Research needs

Several gaps in our understanding of how phosphate oxygen is fractionated in freshwater systems must be addressed before this tracer can be fully utilized in lakes, rivers and streams. As noted in the introduction above, there is a distinct difference between the isotopic fractionation of phosphate oxygen associated with intracellular phosphate cycling versus extracellular phosphate cycling [26]. In estuarine environments, which are typically nitrogen limited

rather than phosphorus limited, extracellular phosphate cycling and its associated kinetic isotope fractionation will most likely play a less important role relative to intracellular biological cycling and its associated equilibrium fractionation. However, many freshwater systems are phosphorus limited [7, 56], and thus extracellular regeneration of dissolved organic carbon compounds may play a larger role in lakes and rivers than in estuaries. Therefore, the relative importance of extracellular versus intracellular biological phosphate cycling in these systems must be more fully understood before phosphate  $\delta^{18}\text{O}_p$  can be fully utilized. Furthermore, there is a dearth of data on the fractionation associated with freshwater periphyton (soft algae and diatoms) and freshwater heterotrophic bacteria. Research has suggested that bacteria are superior competitors for phosphate in aquatic systems compared to phytoplankton [57]; however, differences in isotopic fractionation associated with bacterial cycling of phosphorus compared to algal cycling have not been fully defined. More research is needed to understand how these organisms fractionate phosphate oxygen under a variety of temperature and phosphorus concentration regimes.

Isotopic fractionation associated with sorption onto particulate matter and in association with co-precipitation of phosphate must also be further explored. Phosphate interactions with sediments and co-precipitates in lakes and streams have been found to be an important factor in controlling the dissolved phosphate pool [52, 53]. Immobilization of phosphate in sediment has been found to differ substantially between freshwater and salt water systems. In oxic freshwater environments, phosphorus is strongly immobilized in the sediment; whereas in salt water environments phosphorus is released from sediments in association with benthic decomposition [58]. If precipitation reactions or sorption onto particles have a fractionation associated with them, it could contribute significantly to the measured  $\delta^{18}\text{O}_p$ . Precipitation of phosphate minerals (for example, apatite) in freshwater systems should impart an equilibrium isotopic fractionation [19], which would make such reactions indistinguishable from intracellular biological cycling. However, fractionations associated with sorption and co-precipitation with minerals like calcite has not been characterized. Such effects are assumed to be negligible in most systems but could potentially play a role in hardwater systems where co-precipitation of phosphate can result in the removal of up to 30% of the dissolved P pool [53].

## 6. FUTURE DIRECTIONS

The oxygen isotopic composition of DIP and particulate phosphatic compounds can be utilized for management and restoration efforts as a tracer for phosphate sources. This tracer will be most effective in eutrophic systems in which phosphate concentrations are high and the source signatures minimally altered. When used in this manner,  $\delta^{18}\text{O}_p$  can identify both point sources of phosphate (such as wastewater treatment plant outfall) or non-point sources (like agricultural or urban runoff). Indeed,  $\delta^{18}\text{O}_p$  has already proven to be an excellent tracer for source tracking in estuarine environments [24, 32].

The  $\delta^{18}\text{O}_p$  could potentially be effective as a tracer for phosphate uptake within phosphorus limited streams. Spiking a stream reach with an  $^{18}\text{O}$ -enriched phosphate source and following the change in isotopic signature would be a direct measure of such uptake rates. Understanding phosphate uptake in such streams is encumbered by low phosphate concentrations; however, addition of a phosphate spike to the system and subsequent determination of the isotopic alteration of the spike downstream could potentially provide information on the uptake of phosphate



within the reach (H.M. Valett personal communication). This tracer is currently being developed by H.M. Valett (Virginia Institute of Technology) and others for watersheds in the USA.

## 7. SUMMARY AND CONCLUSION

The  $\delta^{18}\text{O}_p$  stable isotope tracer has been successful in identifying sources and cycling of phosphate in coastal environments. It is particularly useful in estuarine systems due to the mixing of freshwaters (with low  $\delta^{18}\text{O}_w$  and thus, low  $\delta^{18}\text{O}_p$ ) and seawater (with higher  $\delta^{18}\text{O}_w$  and thus, higher  $\delta^{18}\text{O}_p$ ). Sources of phosphate with unique isotopic signatures can be identified as deviations of the simple two-end member mixing line in such systems. The  $\delta^{18}\text{O}_p$  tracer can be utilized in a similar fashion in nutrient rich streams to identify specific sources of phosphate that are causing eutrophic conditions in such systems. In oligotrophic phosphate limited rivers and streams, a number of other factors may confound the  $\delta^{18}\text{O}_p$ . Use of phosphate oxygen isotopic spikes may help understand phosphate uptake in P-limited streams. More research must be conducted before the  $\delta^{18}\text{O}_p$  stable isotope tracer can be fully utilized in such environments.

## REFERENCES

- [1] TILMAN, D., et al., Forecasting agriculturally driven global environmental change, *Science* **292** (2001) 281–284.
- [2] CARPENTER, S.R., CARACO, N.F., CORREL, D.L., HOWARTH, R.W., SHARPLEY, A.H., Nonpoint pollution of surface waters with phosphorus and nitrogen, *Ecol. Appl.* **8** (1998) 559–568.
- [3] RABALAIS, N.N., TURNER, R.E., WISEMAN, W.J., Gulf of Mexico hypoxia, A.K.A. “The dead zone”. *Ann. Rev. Ecol. Systemat.* **33** (2002) 235–263.
- [4] BEMAN, J.M., ARRIGO, K.R., MATSON, P.A., Agricultural runoff fuels large phytoplankton blooms in vulnerable areas of the ocean, *Nature* **434** (2005) 211–214.
- [5] SMITH, R.E.H., KALFF, J., Competition for phosphorus among co-occurring freshwater phytoplankton, *Limnol. Oceanogr.* **28** (1983) 448–464.
- [6] SMITH, S.V., Phosphorus versus nitrogen limitation in the marine environment, *Limnol. Oceanogr.* **29** (1984) 1149–1160.
- [7] SHARP, J.H., Review of Carbon, Nitrogen, and Phosphorus Biogeochemistry, *Rev. Geophys. Supplement* **29** (1991) 648–657.
- [8] BOTHWELL, M.L., Phosphorus limitation of lotic periphyton growth rates: An inter-site comparison using continuous-flow troughs (Thompson River System, British Columbia), *Limnol. Oceanogr.* **30** (1985) 527–542.
- [9] HECKY, R.E., KILHAM, P., Nutrient limitation of phytoplankton in freshwater and marine environments: A review of recent evidence on the effects of enrichment, *Limnol. Oceanogr.* **33** (1988) 796–822.
- [10] HOWARTH, R.W., Nutrient limitation of primary production in marine ecosystems, *Annu. Rev. Ecol. Systemat.* **19** (1988) 89–110.



- [11] SUNDARESHWAR, P.V., MORRIS, J.T., KOEPFLER, E.K., FORNWALT, B., Phosphorus Limitation of Coastal Ecosystem Processes, *Science* **299** (2003) 563–565.
- [12] NICHOLSON, D., DYHRMAN, S., CHAVEZ, F., PAYTAN, A., Alkaline phosphatase activity in the phytoplankton communities of Monterey Bay and San Francisco Bay, *Limnol. Oceanogr.* **51** (2006) 874–883.
- [13] BENITEZ-NELSON, C.R., BUESSELER, K.O., Variability of inorganic and organic phosphorus turnover rates in the coastal ocean, *Nature* **398** (1999) 502–505.
- [14] BENITEZ-NELSON, C.R., BUESSELER, K.O., Measurement of cosmogenic  $^{32}\text{P}$  and  $^{33}\text{P}$  activities in rainwater and seawater, *Analyt. Chem.* **70** (1998) 64–72.
- [15] BENITEZ-NELSON, C.R., KARL, D.M., Phosphorus cycling in the North Pacific Subtropical Gyre using cosmogenic  $^{32}\text{P}$  and  $^{33}\text{P}$ , *Limnol. Oceanogr.* **47** (2002) 762–770.
- [16] LONGINELLI, A., BARTELLONI, M., CORTECCI, G., The isotopic cycle of oceanic phosphate, I, *Earth Planet. Sci. Lett.* **32** (1976) 389–392.
- [17] BLAKE, R.E., Experimental investigations of organic and microbially mediated reactions of aluminosilicates and phosphates, Doctoral Dissertation, University of Michigan, Ann Arbor (1997).
- [18] O’NEIL, J.R., VENNEMANN, T.W., MCKENZIE, W.F., Effects of speciation on equilibrium fractionations and rates of oxygen isotope exchange between  $(\text{PO}_4)_{\text{aq}}$  and  $\text{H}_2\text{O}$ , *Geochim. Cosmochim. Acta* **67** (2003) 3135–3144.
- [19] LONGINELLI, A., NUTI, S., Revised phosphate-water isotopic temperature scale, *Earth Planet. Sci. Lett.* **19** (1973) 373–376.
- [20] BLAKE, R.E., O’NEIL, J.R., GARCIA, G.A., Oxygen isotope systematics of biologically mediated reactions of phosphate: I. Microbial degradation of organophosphorus compounds, *Geochim. Cosmochim. Acta* **61** (1997) 4411–4422.
- [21] LIANG, Y., Oxygen isotope studies of biogeochemical cycling of phosphorus, Yale University, New Haven, Connecticut, USA (2005).
- [22] LIANG, Y., BLAKE, R.E., Oxygen isotope fractionation between apatite and aqueous-phase phosphate: 20–45 °C, *Chem. Geol.* **238** (2007) 121–133.
- [23] JAISI, D.P., BLAKE, R.E., KUKKADAPU, R.K., Fractionation of oxygen isotopes in phosphate during its interactions with iron oxides, *Geochim. Cosmochim. Acta* **74** (2009) 1309–1319.
- [24] McLAUGHLIN, K., CADE-MENUN, B.J., PAYTAN, A., The oxygen isotopic composition of phosphate in Elkhorn Slough, California: A tracer for phosphate sources, *Estuar. Coast. Shelf Sci.* (2006) doi: 10.1016/j.ecss.2006.1006.1030.
- [25] LONGINELLI, A., Ratios of oxygen–18: oxygen–16 in phosphate from living and fossil marine organisms, *Nature* **21** (1966) 923–927.
- [26] BLAKE, R.E., O’NEIL, J.R., SURKOV, A.V., Biogeochemical cycling of phosphorus: Insights from oxygen isotope effects of phosphoenzymes, *Am. J. Sci.* **305** (2005) 596–620.

- [27] LIANG, Y., BLAKE, R.E., Oxygen isotope composition of phosphate in organic compounds: Isotope effects of extraction methods, *Org. Geochem.* **37** (2006) 1263–1277.
- [28] KOLODNY, Y., LUZ, B., NAVON, O., Oxygen isotope variations in phosphate of biogenic apatites, I. Fish bone apatite--rechecking the rules of the game, *Earth Planet. Sci. Lett.* **64** (1983) 398–404.
- [29] PAYTAN, A., KOLODNY, Y., NEORI, A., LUZ, B., Rapid biologically mediated oxygen isotope exchange between water and phosphate, *Glob. Biogeochem. Cycl.* **16** (2002) 1013.
- [30] COLMAN, A.S., The oxygen isotope composition of dissolved inorganic phosphate and the marine phosphorus cycle, PhD thesis, Yale (2002).
- [31] McLAUGHLIN, K., CHAVEZ, F.P., PENNINGTON, J.T., PAYTAN, A., A Time Series Investigation of the Oxygen Isotopic Composition of Dissolved Inorganic Phosphate in Monterey Bay, *Limnol. Oceanogr.* **51** (2006) 2370–2379.
- [32] McLAUGHLIN, K., PAYTAN, A., KENDALL, C., SILVA, S.R., Phosphate oxygen isotopes as a tracer for sources and cycling of phosphate in North San Francisco Bay, *J. Geophys. Res.: Biogeosci.* **111** (2006) doi: 10.1029/2005JG000079.
- [33] ESLBURY, K.E., et al., Using Oxygen Isotopes of Phosphate to Trace Phosphorus Sources and Cycling in Lake Erie, *Environ. Sci. Technol.* **43** (2009) 3108–3114.
- [34] GRUAU, G., et al., The oxygen isotopic composition of dissolved anthropogenic phosphates: a new tool for eutrophication research?, *Water Res.* **39** (2005) 232–238.
- [35] YOUNG, M.B., et al., Characterizing the oxygen isotopic composition of phosphate sources to aquatic systems, *Environ. Sci. Technol.* **43** (2009) 5190–5196.
- [36] MCLAUGHLIN, K., KENDALL, C., SILVA, S., STUART-WILLIAMS, H., PAYTAN, A., A precise method for the analysis of  $\delta^{18}\text{O}$  of dissolved inorganic phosphate in seawater, *Limnol. Oceanogr. Methods* **2** (2004) 202–212.
- [37] McLAUGHLIN, K., KENDALL, C., SILVA, S.R., PAYTAN, A., Oxygen isotopes of phosphatic compounds — Application for marine particulate matter, sediments and soils, *Mar. Chem.* **98** (2006) 148–155.
- [38] TUDGE, A.P., A method of analysis of oxygen isotopes in orthophosphate--its use in the measurement of paleotemperatures, *Geochim. Cosmochim. Acta* **18** (1960) 81–93.
- [39] FIRSCHING, F.H., Precipitation of silver phosphate from homogeneous solution, *Analyt. Chem.* **33** (1961) 873–874.
- [40] O'NEIL, J.R., ROE, L.J., REINHARD, E., BLAKE, R.E., A rapid and precise method of oxygen isotope analysis of biogenic phosphate, *Israel J. Earth Sci.* **43** (1994) 203–212.
- [41] COLMAN, A.S., The oxygen isotope composition of dissolved inorganic phosphate and the marine phosphorus cycle, PhD thesis, Yale (2002).
- [42] VENNEMANN, T.W., FRICKE, H.C., BLAKE, R.E., O'NEIL, J.R., COLEMAN, A., Oxygen isotope analysis of phosphates: a comparison of techniques for analysis of  $\text{Ag}_3\text{PO}_4$ , *Chem. Geol.* **185** (2002) 321–336.
- [43] BLAKE, R.E., Yale University, New Haven, CT, USA, unpublished data.

- [44] TAMBURINI, F., BERNASCONI, S.M., ANGERT, A., et al., A method for the analysis of the  $\delta^{18}\text{O}$  of inorganic phosphate in soils extracted with HCl, *Europ. J. Soil Sci.* **61** (2010) 1025–1032.
- [45] ZOHAR, I., PAYTAN, A., SHAVIV, A., A method for the analysis of oxygen isotopic composition of various soil phosphate fractions, *Environ. Sci. Technol.* **44** 19 (2010) 7583–7588.
- [46] COLMAN, A.S., BLAKE, R.E., KARL, D.M., FOGEL, M.L., TUREKIAN, K.K., “Marine phosphate oxygen isotopes and organic matter remineralization in the oceans”, *Proc. National Academy of Sciences of the United States of America* **102** (2005) 13023–13028.
- [47] INGRAM, B.L., CONRAD, M.E., INGLE, J.C., Stable isotope and salinity systematics in estuarine waters and carbonates: San Francisco Bay, *Geochim. Cosmochim. Acta* **60** (1996) 455–467.
- [48] HARRIS, G.P., Biogeochemistry of nitrogen and phosphorus in Australian catchments, rivers and estuaries: Effects of land use and flow regulation and comparisons with global patterns, *Mar. Freshw. Res.* **52** (2001) 139–149.
- [49] NEILL, C., DEEGAN, L.A., THOMAS, S.M., CERRI, C.C., Deforestation for pasture alters nitrogen and phosphorus in small Amazonian streams, *Ecol. Appl.* **11** (2001) 1817–1828.
- [50] LEHRTER, J.C., Effects of land use and land cover, stream discharge, and interannual climate on the magnitude and timing of nitrogen, phosphorus and organic carbon concentrations in three coastal plain watersheds, *Water Environ. Res.* **78** (2006) 2356–2368.
- [51] FROELICH, P.N., Kinetic control of dissolved phosphate in natural rivers and estuaries: A primer on the phosphate buffer mechanism, *Limnol. Oceanogr.* **33** (1988) 649–668.
- [52] FOX, L.E., Model for inorganic control of phosphate concentrations in river waters, *Geochim. Cosmochim. Acta* **53** (1989) 417–428.
- [53] HOUSE, W.A., Geochemical cycling of phosphorus in rivers, *Appl. Geochem.* **18** (2003) 739–748.
- [54] TZORAKI, O., NIKOLAIDIS, N.P., AMAXIDIS, Y., SKOULIKIDIS, N.T., In-stream biogeochemical processes of a temporary river, *Environ. Sci. Technol.* **41** (2007) 1225–1231.
- [55] ELSBURY, K.E., et al., Using Oxygen Isotopes of Phosphate To Trace Phosphorus Sources and Cycling in Lake Erie, *Environ. Sci. Technol.* **43** (2009) 3108–3114.
- [56] SCHLESINGER, W.H., *Biogeochemistry, An Analysis of Global Change*, 2nd edition, Academic Press, San Diego (1991).
- [57] CURRIE, D.J., KALFF, J., A comparison of the abilities of freshwater algae and bacteria to acquire and retain phosphorus, *Limnol. Oceanogr.* **29** (1984) 298–310.
- [58] CARACO, N., COLE, J., LIKENS, G.E. NA comparison of phosphorus immobilization in sediments of freshwater and coastal marine systems, *Biogeochemistry* **9** (1990) 277–290.

# INVESTIGATING PATHWAYS OF NUTRIENT AND ENERGY FLOWS THROUGH AQUATIC FOOD WEBS USING STABLE ISOTOPES OF CARBON AND NITROGEN.

W.L. HADWEN, S.E. BUNN  
Australian Rivers Institute,  
Griffith School of Environment,  
Griffith University, Nathan Campus,  
Brisbane, Queensland, Australia

## Abstract

Carbon and nitrogen stable isotopes can provide valuable insights into pathways of nutrient and energy flows in aquatic ecosystems. Carbon stable isotopes are principally used to trace pathways of organic matter transfer through aquatic food webs, particularly with regard to identifying the dominant sources of nutrition for aquatic biota. Stable isotopes of carbon have been widely used to answer one of the most pressing questions in aquatic food web ecology — to what degree do in-stream (autochthonous) and riparian (allochthonous) sources of energy fuel riverine food webs? In conjunction with carbon stable isotopes, nitrogen stable isotopes have been used to determine the trophic position of consumers and to identify the number of trophic levels in aquatic food webs. More recently, stable nitrogen isotopes have been recommended as indicators of anthropogenic disturbances. Specifically, agricultural land uses and/or sewage effluent discharge have been shown to significantly increase  $\delta^{15}\text{N}$  signatures in primary producers and higher order consumers in freshwater, estuarine and marine environments. Together, carbon and nitrogen stable isotopes can be used to examine natural food web functions as well as the degree to which human modifications to catchments and aquatic environments can influence aquatic ecosystem function.

## 1. INTRODUCTION

One of the fundamental questions in aquatic ecology is, “To what degree are food webs fuelled by allochthonous (external) or autochthonous (in-stream autotrophs) sources of carbon?” [1–4]. Whilst early efforts to answer this question relied heavily on gut contents analyses, the results were equivocal due to uncertainties relating to the ingestion vs assimilation of food sources [4]. Stable isotopes of carbon and nitrogen, have therefore, revolutionised studies of aquatic food webs, as they can provide an element-based assessment of the degree to which autochthonous and allochthonous sources contribute to consumers [4, 5]. Answering questions about the source(s) of energy and nutrients fuelling riverine food webs has broad implications for our understanding of ecosystem functioning and response(s) to human-mediated and natural disturbances [6]. Furthermore, since modern water resource management goals increasingly aim to link nutrient guidelines to those that relate to aspects of ecosystem structure and function (e.g. Refs [7, 8]), stable isotopes can provide managers with an excellent tracer that can link these objectives.

Naturally occurring stable isotopes of carbon and nitrogen act as markers of an organism’s diet, especially when the consumed sources of energy have unique signatures [4, 5]. In aquatic ecosystems, the major sources of energy, or organic matter, of interest to managers and researchers are those that are derived from external (allochthonous) sources (e.g. riparian trees or catchment sources) and those that are derived from in-stream (autochthonous) primary producers. Examination of the carbon and nitrogen stable isotope signatures of these two source

groups generally results in good separation (i.e. low or no overlap in isotope signatures) and this separation of sources is a fundamental assumption and requirement in food web studies in aquatic ecosystems [4, 9–11].

Historically, food web studies using stable isotopes of carbon and nitrogen have presented data in the form of  $\delta^{15}\text{N}$  versus  $\delta^{13}\text{C}$  bi-plots [12] (Fig. 1). Early interpretations were based on these figures, with the underlying understanding that carbon and nitrogen isotope signatures reveal the source of food and the trophic position of organisms within the food web. Specifically, carbon signatures relate directly to food sources utilised by consumers — ‘you are what you eat’ [4]. Nitrogen stable isotope signatures (on the y axis) are used to determine an organism’s trophic position, owing to a regular and predictable fractionation of nitrogen with each trophic step [13].

Trophic fractionation of nitrogen was originally reported at 3.4‰ per trophic step [14], but there has been considerable debate recently regarding this value of  $\delta^{15}\text{N}$  trophic fractionation. Significantly, recent reviews and field and laboratory studies have suggested that: (a) nitrogen stable isotope fractionation is generally not as large as 3.4‰ per trophic step [15, 16]; (b) trophic fractionation is often different between species and between tissues within species [17]; (c) trophic fractionation is influenced by food sources and metabolic activity of the consumer [18–20], and (d) there may be differences in trophic fractionation in different aquatic environments [20, 21]. Whilst further research is required into nitrogen stable isotope fractionation and its relationship to trophic interactions and trophic levels and the implications of fractionation variability on food web interpretations, nitrogen stable isotopes have been used

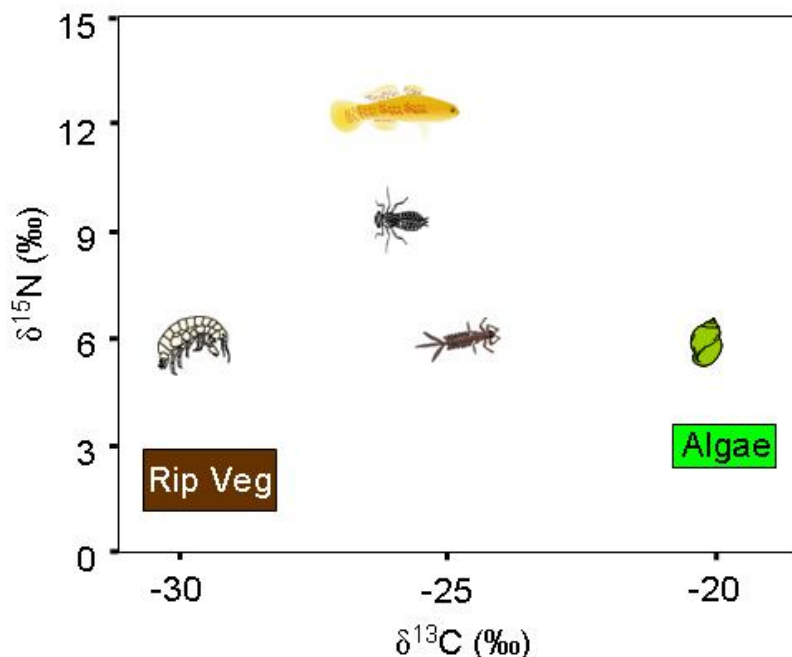

FIG. 1. Hypothetical example of a  $\delta^{15}\text{N}$  versus  $\delta^{13}\text{C}$  bi-plot of food web data from an aquatic ecosystem. Consumers feeding exclusively on a single food resource will have matching  $\delta^{13}\text{C}$  signatures to that food resource. Consumers feeding on a combination of food sources will have  $\delta^{13}\text{C}$  signatures that reflect the relative proportion of each source consumed. Consumers are  $^{15}\text{N}$ -enriched relative to their food, resulting in  $^{15}\text{N}$  enrichment with each trophic step within the food web.



successfully to examine trophic relationships and patterns of movement in aquatic organisms [13, 22, 23].

In Australian aquatic environments, our research group has been addressing a range of ecological and management questions using stable isotope techniques. Whilst the majority of our work has used natural abundance approaches [3, 24], we have also successfully used  $^{15}\text{N}$ -enriched tracers to examine nutrient flows into primary producers [25] and up through aquatic food webs [26]. Furthermore, we have conducted studies in systems with high levels of  $^{15}\text{N}$ -enrichment, principally from point source (sewage) inputs, that have contributed to our understanding of food web structure and functioning and the identification of new recruits in intermittently open estuaries [23, 27]. In this paper, we review the wide variety of approaches using stable isotopes of carbon and nitrogen that can be adopted to tackle management and ecological questions in aquatic food webs and highlight the utility of stable isotopes in revealing the type and extent of food web interactions.

## **2. MATERIALS AND METHODS**

With their growing acceptance and application worldwide, stable isotopes of carbon and nitrogen have been used in food web studies across a broad range of aquatic environments [4, 10]. Food web studies have been conducted in rivers, lakes, wetlands and estuaries (and other marine environments), and as discussed above, most of these studies have attempted to gain insight into the relative importance of in situ versus transported sources of carbon as the dominant sources of energy fuelling consumer organisms.

### **2.1. Contrasting gut contents and stable isotope approaches to diet reconstructions**

Historical studies of trophic interactions have been based on assessments of the gut contents of target taxa, with inferences made regarding the relative abundance, and therefore importance, of the prey items encountered. Whilst this has revealed substantial information relating to ontogenetic and spatial and temporal shifts in the diets of macroinvertebrates and fish, critics of this approach have noted that some consumed items may pass through the gut of a consumer and not actually contribute much, if anything, to the consumer's nutrition [4]. These criticisms, and others relating to the scale of gut content investigations and their relationship to management issues, have led to the rise of stable isotope techniques to resolve consumer diets, as the isotopic signatures of muscle tissues are undeniably related to the isotopic signatures of prey items that have been assimilated across the gut wall [4].

Despite the limitations of gut contents studies, paired assessments of trophic relationships using gut contents and stable isotope data promise much in terms of resolving short (day to day) and medium (weeks to months) term variability in consumer diets (see Refs [27–31]). For example, Hadwen et al. [27] used a paired approach to resolve temporal fluctuations in the relative importance of prey items to the diets of four commercially important fish species in two intermittently open estuaries. In that study, analyses revealed that short term switches in consumption patterns may not be immediately detected using stable isotopes. Ultimately, whilst stable isotopes do provide an approach that focuses on the assimilation of carbon and nitrogen from prey tissues, the type and scale of ecological and management questions may or may not be best approached using this method. Furthermore, stable isotope approaches using natural abundances of carbon and nitrogen isotopes do not always yield data that can



definitively answer specific research questions [4]. Given this context, Hadwen et al. [27] suggested that many studies would benefit from a paired gut contents–stable isotope approach, whereby the methods used and interpretations garnered can benefit from the strengths of each approach.

## **2.2. Natural abundance stable isotope studies**

The majority of food web studies using stable isotopes of carbon and nitrogen rely on the natural abundance of these isotopes to infer trophic relationships [4]. In studies of this type, the ambient  $\delta^{13}\text{C}$  and  $\delta^{15}\text{N}$  signatures of source materials and consumers can reveal trophic interrelationships (see Fig. 1). However, it must be remembered that interpretation of feeding relationships using stable isotopes requires good separation of the isotopic signatures of key energy sources in the system [4, 11].

### **2.2.1. Sampling procedures**

Sampling food webs requires an understanding of the anticipated species present at any given site and the sources of energy that they are likely to derive their nutrition from. Typically, researchers attempt to collect a representative sample from the community in question, with efforts strongly influenced by the duration and timing of sample collections. From our experience, collecting sufficient and representative materials for stable isotope investigations of food web structure and functioning requires considerable field effort, with our sampling generally taking between three and five hours per site. The specific details for sampling activities are not provided in this document; for details of sampling procedures, we recommend that practitioners refer to relevant papers in the reference list and others in the primary literature.

### **2.2.2. $^{15}\text{N}$ -enriched tracer studies**

Numerous researchers have sought to gain a better understanding of nutrient and carbon transformations and trophic pathways by using enriched isotope tracers in aquatic ecosystems [25, 26, 32–34]. Many studies have focused on nitrogen dynamics (uptake, assimilation, transformation) in small streams and have incorporated food web studies within these approaches (e.g. Refs [33, 34]). In these studies, enriched tracers have typically been added to streams via a regulated drip system, with the aim to ultimately, over the course of the study, enrich all components of the food web, especially the metabolically active components. In other aquatic ecosystems, like lakes and larger rivers, the addition of a  $^{15}\text{N}$ -enriched tracer has been conducted using mesocosms [32] or small enclosures [25] to achieve optimal enrichment.

An example of the use of  $^{15}\text{N}$  tracers to answer specific management questions is shown in a study by Hadwen and Bunn [26], which aimed to examine a nutrient management issue in the World Heritage listed lakes on Fraser Island, off the Queensland coast in Australia. Specifically, natural resource managers were concerned about tourist mediated nutrient inputs into the ultra-oligotrophic perched dune lakes and wanted to know about the potential ecological implications of these nutrient inputs [35]. To help answer these questions, we conducted nutrient bioassays examining algal community response to nutrient additions [36] and developed a  $^{15}\text{N}$  tracer addition experiment to identify the degree to which added nutrients make their way into higher trophic levels [36]. Importantly, the addition of a  $^{15}\text{N}$ -enriched tracer enabled a very low concentration of nutrients to be added to an oligotrophic ecosystem. Furthermore, in the context of the natural resource managers' concerns, adding nutrients at

appropriate concentrations that mimicked the likely inputs from tourists was also deemed to be an important strength of this approach. For full methodological details of this study, refer to Hadwen and Bunn [36].

### 2.2.3. *Studies in <sup>15</sup>N-enriched ecosystems*

Catchment modifications and point source contributions of <sup>15</sup>N-enriched effluent have been shown to increase the  $\delta^{15}\text{N}$  signatures of primary producers and higher trophic levels in rivers, lakes and estuaries [23, 37–40]. In these polluted and <sup>15</sup>N-enriched systems, we can use our knowledge of stable isotopes to develop a greater understanding of aspects of both food web and community ecology. In essence, <sup>15</sup>N-enriched aquatic ecosystems can be considered to be large scale enrichment studies, without the logistics and expense of adding <sup>15</sup>N-enriched tracers. Hadwen and Arthington [23] examined the food webs of two intermittently open estuaries receiving <sup>15</sup>N-enriched sewage inputs before and after an estuary entrance opening event and their work revealed that the enriched signatures in resident biota ensured that new recruits to the system were isotopically unique. Studies of this type can, therefore, also provide us with insights into recruitment events and strategies of key species of interest.

### 2.2.4. *Sample processing procedures*

For all samples, whether collected as natural abundance or <sup>15</sup>N-enriched tracer experiments, there are standard procedures with respect to laboratory handling and processing. As for sampling procedures, the precise details of laboratory processing are not provided in this document. Again, in light of specific questions which could be asked and the laboratory through which samples would be processed, we suggest that practitioners examine the primary literature and contact the appropriate laboratory supervisor to learn more about the specific details of laboratory processing. Samples are analysed using a continuous flow isotope ratio mass spectrometer (e.g. the one at Griffith University is a GV Isoprime Eurovector EA 3000, Manchester, UK). Isotope ratios are expressed as  $\delta^{13}\text{C}$  (ratio of <sup>13</sup>C:<sup>12</sup>C) and  $\delta^{15}\text{N}$  (ratio of <sup>15</sup>N:<sup>14</sup>N) and are determined against laboratory standard reference materials (ANU sucrose for  $\delta^{13}\text{C}$  and ambient N for  $\delta^{15}\text{N}$ ). Values are reported according to the following equation:

$$\delta^{13}\text{C} \text{ or } \delta^{15}\text{N} = [(R_{\text{sample}} / R_{\text{standard}}) - 1] \times 1000\text{‰}$$

Where:  $R_{\text{sample}}$  is the isotopic ratio for the sample and  $R_{\text{standard}}$  is the isotopic ratio of the standard (lab standard referenced to PeeDee belemnite carbonate for  $\delta^{13}\text{C}$  and atmospheric N for  $\delta^{15}\text{N}$ ).

## 2.3. **Data interpretation and analyses**

Early studies which sought to examine the relative importance of source materials to consumer diets were hampered by the qualitative nature of bi-plot interpretations [41]. In response to these constraints, numerous mixing models have been developed on the quantitative aspect of interpretation. One of the earliest versions of a simple stable isotopes mixing model for use in food web studies was that of Boon and Bunn [42]. In their studies, quantitative analyses were restricted to comparisons of two sources, using the following formula:

$$P_A = (\delta_{\text{consumer}} - f - \delta_B) / (\delta_A - \delta_B) \text{ and } P_B = 1 - P_A$$

Where:

$P_A$  is proportion of source A;

- $f$  is isotopic fractionation (‰) (consumer – diet);  
 $\delta_A$  is  $\delta^{13}\text{C}$  of source A (‰);  
 $\delta_B$  is  $\delta^{13}\text{C}$  of source B (‰).

Building on ideas like those developed by Bunn and Boon [42], there has been a relatively recent proliferation of mixing model approaches for stable isotopes in food web ecology. Some of the most widely used mixing models have been developed by Donald Phillips and his collaborators from the US EPA [43–46]. Concentration dependent [44] and multiple source [47] mixing models have revolutionised the use and quantitative analysis of carbon and nitrogen stable isotopes in food web ecology (for examples, see Refs [41, 48, 49]).

At present, perhaps the dominant mixing model for use in food web studies is called IsoSource, and this model was developed by Phillips and Gregg [45] to accommodate multiple sources, or end members, and multiple isotopes in analyses. Previous mixing models had largely limited the number of possible sources, or end members, to three (or two) and improved field sampling techniques have revealed that the number of possible source materials is frequently much higher than that existing in most systems. The IsoSource mixing model calculates feasible combinations (in 1% increments) of autotroph isotope signatures that explain observed consumer isotope signatures. In our analyses, combinations of end member signatures that add up to within 0.01% of the consumer signature are generally considered feasible, although the model can be adjusted by the user to take into consideration less statistically confined model predictions. As trophic fractionations of carbon are reported as being generally low (less than 1%), we tend not to correct these analyses [5, 15].

Although nitrogen stable isotope signatures have historically been used in conjunction with carbon stable isotope signatures in food web studies, there is increasing uncertainty relating to  $^{15}\text{N}$  trophic fractionation. This has implications for food web analyses, and as a result, some researchers have decided not to include  $\delta^{15}\text{N}$  signatures in their analyses due to unknown levels of fractionation in study organisms (sensu Refs [23, 50]), particularly in sites with elevated  $\delta^{15}\text{N}$  signatures due to inputs from  $^{15}\text{N}$ -enriched point sources (sensu Ref [23]).

Since the main question asked (and answered) in food web studies using stable isotopes of carbon and nitrogen is, “Are food webs predominantly fuelled by autochthonous (in situ) or allochthonous (external/transported) sources of organic matter?”, we advocate an approach to mixing models that only uses ‘pure’ sources as end members in the IsoSource mixing model (sensu Refs [23, 27]). Specifically, the end members that are routinely used in analyses are species from riparian vegetation, water column algae (sometimes referred to as seston) and benthic algae (including epilithon, epiphyton, filamentous algae and biofilm). Benthic sediments, including CPOM and FPOM are not used as end members on the basis that each of these sources is a mixture of the ‘pure’ end members listed above. Specifically, analyses tend to reveal that CPOM is largely derived from riparian vegetation and that FPOM stable isotope signatures are consistent with them, being combinations of autochthonous (algal) and allochthonous (riparian vegetation) carbon sources [24, 26]. While aquatic submerged and/or emergent macrophytes are often present in riverine, wetland and estuarine sites, these sources are not typically included in the mixing model analyses on the basis of previous studies that have shown that aquatic macrophytes do not directly contribute to the diets of consumers [9, 42, 51, 52].

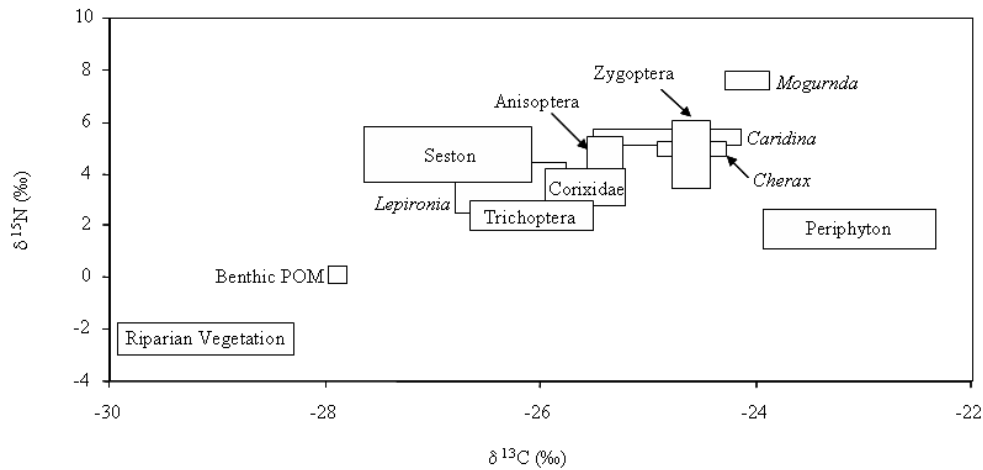

FIG. 2. An example of a stable isotope  $\delta^{13}\text{C}$  versus  $\delta^{15}\text{N}$  bi-plot of the food web of Lake McKenzie, Fraser Island, Australia. Modified from Ref. [26]. Boxes represent mean ( $\pm$  SE) stable isotope signatures of each food web component.

### 3. RESULTS

#### 3.1. Source signature variability and source overlap

Across a wide range of aquatic ecosystems, researchers have measured a very wide range of source carbon isotope signatures. However, despite this variation, some general trends in values for key sources of organic matter are evident. Specifically, riparian vegetation (C4 plants) tends to have carbon isotope signatures between  $-28\text{‰}$  and  $-30\text{‰}$  (see Fig. 2). In contrast, algal and macrophyte  $\delta^{13}\text{C}$  signatures can be highly variable in space and time and can range from around  $-40\text{‰}$  to  $-10\text{‰}$ , but are most typically in the range of  $-15\text{‰}$  to  $-25\text{‰}$  (see Fig. 2). For algae, researchers have linked aspects of flow, light and water quality to changes in  $\delta^{13}\text{C}$  signatures, so it is important that these aspects of the natural environment are accounted for, or controlled, in food web studies that are conducted across multiple sites and/or times. Variability in autochthonous signatures and relative stability in allochthonous (principally riparian) source signatures generates variability in our interpretations of the degree to which consumers rely on these groups of sources.

#### 3.2. Strong reliance on autochthonous carbon sources in aquatic ecosystems

Stable isotope data from rivers, lakes and estuaries that we have worked on in Australia tend to reveal strong consumer dependence on autochthonous sources of carbon and relatively minor contributions from riparian vegetation (see Fig. 2).

#### 3.3. $^{15}\text{N}$ tracer addition

In the study by Hadwen and Bunn [26], periphyton responded rapidly to littoral zone additions of the  $^{15}\text{N}$ -enriched tracer (Fig. 3). Indeed, just five hours after the first addition, periphyton  $\delta^{15}\text{N}$  signatures from the enriched site were more than an order of magnitude higher than those from periphyton samples collected from the control site. One day after the initial addition, enriched site periphyton  $\delta^{15}\text{N}$  signatures had fallen substantially, but were still seven times greater than those measured from control sites. Significantly, 24 hours after the initial  $^{15}\text{N}$ -enriched

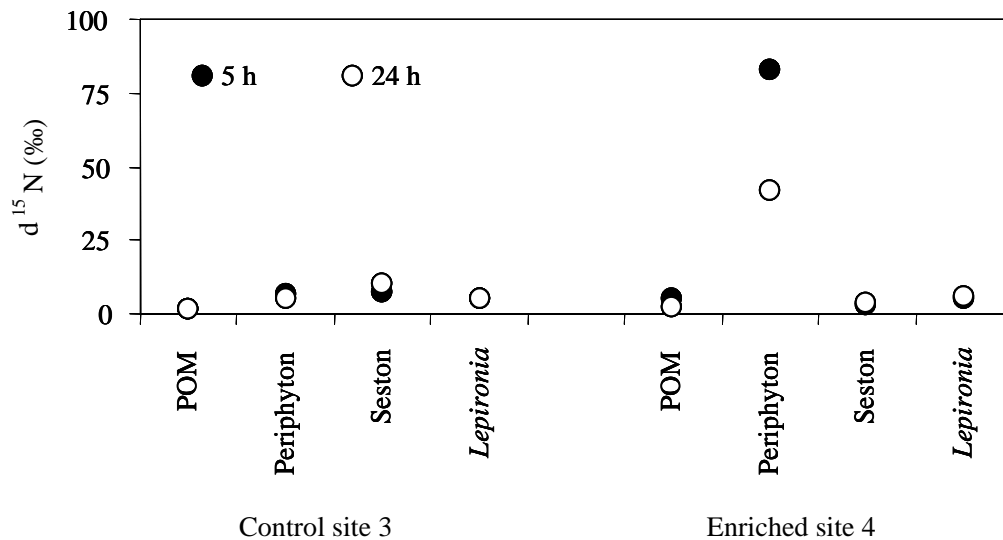

FIG. 3.  $\delta^{15}\text{N}$  signatures of primary food sources collected from site 3 (control) and site 4 (enriched) in Lake McKenzie five hours and 24 hours after the initial  $^{15}\text{N}$ -enriched nutrient addition within the  $^{15}\text{N}$ -tracer addition experiment.

TABLE 1. MEAN ( $\pm$  SE)  $\delta^{15}\text{N}$  SIGNATURES (‰) OF LITTORAL ZONE FOOD WEB COMPONENTS BEFORE AND AFTER REPEATED NUTRIENT AND  $^{15}\text{N}$ -ENRICHED TRACER ADDITIONS IN ENRICHED SITES OF LAKE MCKENZIE ( $N \geq 3$  for each component sampled)

Component	$\delta^{15}\text{N}$ before enrichment	$\delta^{15}\text{N}$ after enrichment
Benthic POM	0.5 (0.6)	101.4 (41.8)
Seston	3.3 (2.2)	42.5 (1.2)
Lepironia	3.6 (2.2)	164.4 (108.0)
Periphyton	2.6 (0.3)	238.9 (85.2)
Trichopterans	3.4 (0.1)	249.1 (132.7)
Corixids	2.8 (0.3)	7.6 (0.6)
Zygopterans	3.8 (1.5)	77.8 (12.5)
Caridina	5.2 (0.0)	33.2 (8.6)
Cherax	5.3 (0.5)	10.2 (1.3)
Mogurnda adspersa	7.3 (0.2)	10.1 (0.4)

tracer addition, none of the other primary carbon sources (POM, seston and *Lepironia*) was enriched relative to samples from the control site.

At completion of the experiment, the  $\delta^{15}\text{N}$  signatures of all primary producers and primary consumers sampled from enriched sites were enriched relative to equivalent samples taken prior to the initial spike (Table 1). Periphyton was the most enriched primary food source, with a mean  $\delta^{15}\text{N}$  of 238.9‰ ( $\pm$  85.2) across the three enriched sites (Table 1). Consumers showed highly variable, yet substantial increases in  $\delta^{15}\text{N}$  signatures. Trichopteran (caddis fly) larvae were the most enriched component of the food web at the completion of the experiment, with mean  $\delta^{15}\text{N}$  signatures greater than those of all primary carbon food sources (Table 1). In con-

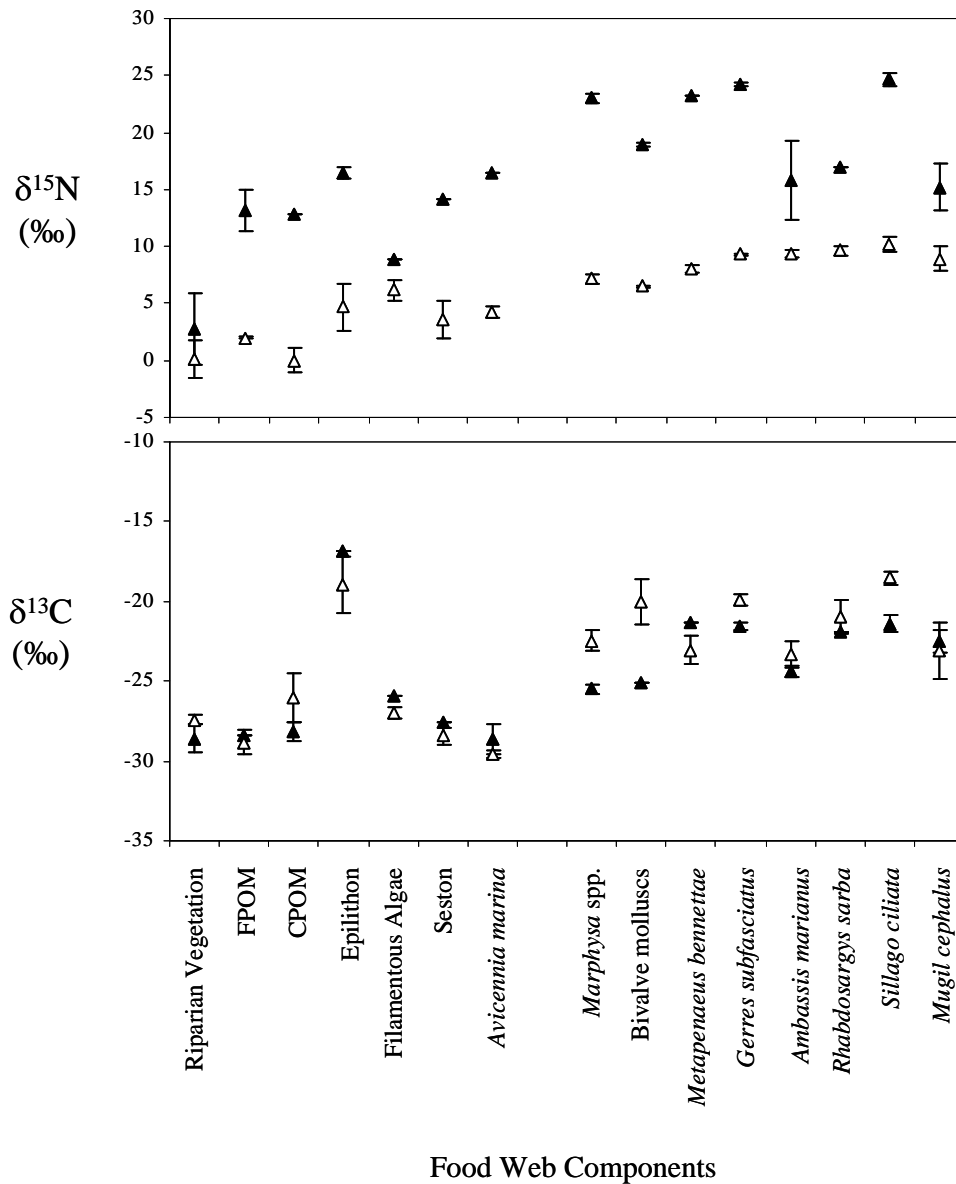

FIG. 4. Mean ( $\pm$  SE)  $\delta^{15}\text{N}$  and  $\delta^{13}\text{C}$  signatures of all food web components collected from Tallows (solid symbols) and Belongil (open symbols) Creeks in May 2003. Figure modified from Ref. [23].

trast, Hemipteran (Corixidae)  $\delta^{15}\text{N}$  signatures rose by less than 5‰ in the enriched sites over the course of the experiment. For larger, long lived consumers such as *Cherax* and *Mogurnda adspersa*, a few, but not all, of the individuals collected had  $\delta^{15}\text{N}$  signatures elevated above those of individuals at the beginning of the experiment.

### 3.4. Studies in <sup>15</sup>N-enriched ecosystems

Food web studies comparing stable isotope signatures of primary producers and consumer taxa in paired systems (Tallows and Belongil Creeks) receiving <sup>15</sup>N-enriched sewage inputs reveal a substantial enrichment in response to the sewage inputs (Fig. 4). These findings indicate that enriched sources of nitrogen are transferred up through the food web and this is mirrored in



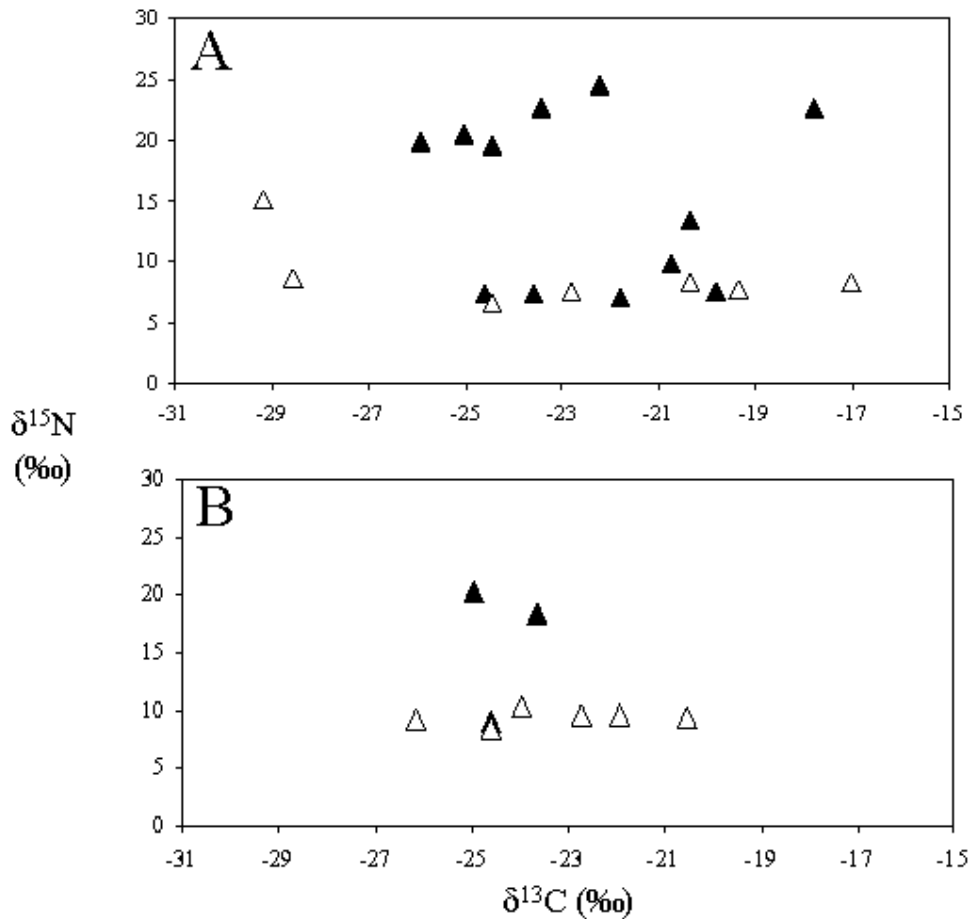

FIG. 5. Examination of overlap between resident and new recruits —  $\delta^{15}\text{N}$  isotope signatures versus  $\delta^{13}\text{C}$  isotope signatures of (A) *Mugil cephalus* and (B) *Ambassis marianus* collected from Tallows (solid symbols) and Belongil (open symbols) Creeks in May 2003.

the high contribution of algal carbon to consumer nutrition in systems with high ambient nutrient concentrations.

Analyses of  $\delta^{15}\text{N}$  isotope signatures of two species of fish (*Ambassis marianus* and *Mugil cephalus*) in Tallows Creek shortly after the system was hydrologically reconnected to the ocean revealed significant differences between some individuals (Fig. 5). Specifically, some were  $^{15}\text{N}$ -enriched in line with anticipated increases in  $\delta^{15}\text{N}$  due to the enriched system, whilst others were comparatively  $^{15}\text{N}$ -depleted, with signatures more similar to those of these species in Belongil Creek, which does not have a  $^{15}\text{N}$ -enriched signature. The  $^{15}\text{N}$ -depleted individuals are considered to be new recruits into Tallows Creek by virtue of their nitrogen isotope signatures, in no way reflecting conditions in Tallows Creek during the antecedent weeks and months.

### 3.5. Contrasting gut contents and stable isotope approaches to diet reconstructions

Studies using both gut contents and stable isotope approaches to reconstruct fish diets in Tallows and Belongil Creeks revealed significant differences in the apparent contribution of prey items to the diet of sand whiting, *Sillago ciliata* (Fig. 6). Whilst more individuals could be assessed using the stable isotope approach (25% of the collected individuals had no gut contents), gut contents analyses revealed a narrower diet than did stable isotope data.

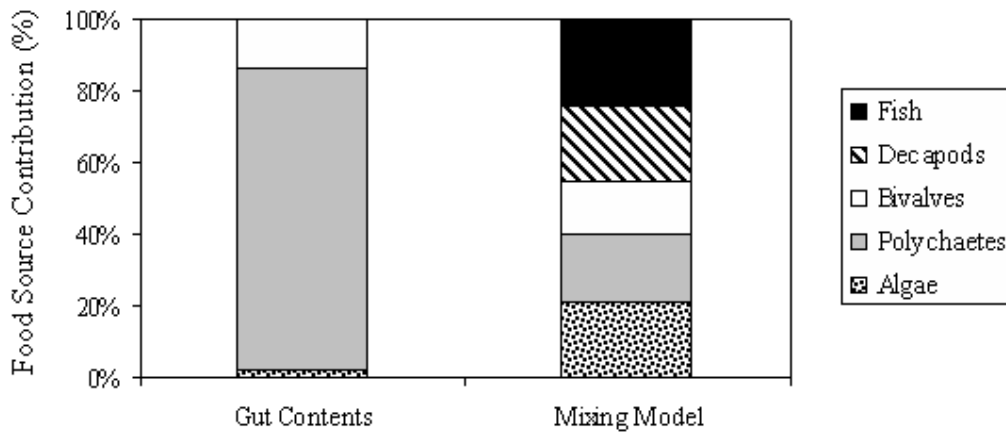

FIG. 6. Comparison of average percentage contribution of prey types to the diet of *Sillago ciliata* on the basis of gut contents and stable isotope analyses of dietary composition for individuals collected in Belongil Creek. Figure modified from Ref. [23].

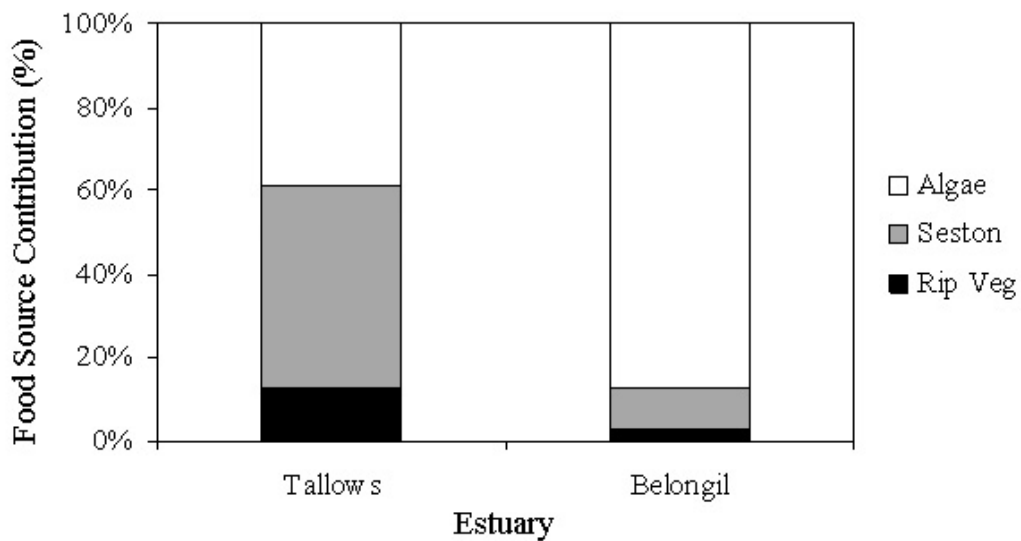

FIG. 7. Mixing model analyses of average percent contributions of dominant carbon sources to *Mugil cephalus* diets from individuals collected from Tallows ( $n = 12$ ) and Belongil ( $n = 13$ ) Creeks. Figure modified from Ref. [23].

Stable isotope analyses were vastly more successful in resolving the dietary contributions of sources to the benthic detritivore *Mugil cephalus* than were gut contents analyses. For this species, a high proportion of unidentifiable matter in the guts of individuals rendered the gut contents approach useless. In contrast, stable isotope mixing model analyses revealed significant differences in the contribution of riparian vegetation, epilithon and seston to *M. cephalus* diets in Tallows and Belongil Creeks (Fig. 7).

## 4. DISCUSSION

Stable isotopes of carbon and nitrogen can help answer fundamental ecological questions, in addition to solving applied problems relating to the source, type and input of organic matter and nutrients in aquatic ecosystems [4, 5]. Indeed, natural abundance and tracer addition stable isotope studies have revealed much about the processing of organic matter and nitrogen through stream, river, wetland, lake and estuarine environments [10, 53, 54]

Whilst stable isotopes can be used to examine a wide range of environmental processes in aquatic ecosystems, the stable isotopes of carbon and nitrogen have been most widely used in food web research, with particular emphasis on examining the pathways and fates of organic matter and nutrients. Early stable isotope studies highlighted the superiority of these techniques over gut contents approaches in determining trophic interactions in food webs, but it should be noted that many recent studies have used a paired gut contents–stable isotope approach to resolve dietary flexibility over different temporal scales [27, 30, 55]. Current research activities, especially those examining the role of lipids in influencing tissue carbon and nitrogen isotope signatures, promise to further enhance our capacity to examine diets and perhaps the physiology of aquatic consumers [56].

Linked to these studies are growing efforts to resolve the question of nitrogen stable isotope trophic fractionation [16, 18, 19, 57]. As mentioned in the introduction, the 3.4‰ enrichment per trophic step proposed in the 1980s no longer seems globally applicable (see Ref. [58]); laboratory and, to a lesser degree, field studies of species specific fractionation levels are required to further resolve this area of uncertainty.

The case studies provided in this paper document the appeal and utility of stable isotope techniques to investigate issues of aquatic ecosystem functioning and management. Natural abundance studies have revealed that in many environments, the most abundant carbon sources (often macrophytes or riparian leaf litter in terms of biomass) are not always the dominant sources of carbon driving aquatic food webs. These findings have strong implications for the scientific understanding of aquatic ecosystem functioning, particularly in light of the prevailing conceptual models of riverine function (e.g. River Continuum Concept of Vannote et al. [59]; Flood Pulse Concept of Junk et al. [1]; Riverine Productivity Model of Thorp and Delong [60]). Furthermore, our growing knowledge of food web dynamics in aquatic ecosystems will also provide valuable information on the sustainable management of natural resources, particularly in highly modified catchments [6, 58].

The  $^{15}\text{N}$ -tracer addition of Hadwen and Bunn [26] enabled identification of a clear pathway of nutrient inputs in a pristine lake environment, without the difficulties and logistical problems associated with other experimental approaches that would have required the addition of substantial quantities of nutrients in experimental mesocosms. By conducting small scale nutrient additions, using a  $^{15}\text{N}$ -enriched tracer, the study was able to identify an in situ mechanism of nutrient uptake and assimilation by periphyton. On the basis of this study, natural resource managers charged with managing visitor use of this aquatic ecosystem could easily see the likely ecological implications of tourist-mediated nutrient inputs into the system and were able to make informed management decisions regarding regulation of visitor activities and lake use to reduce the likelihood of excessive periphyton biomass and/or significant changes in how the food web in Lake McKenzie operates.

Case studies in  $^{15}\text{N}$ -enriched systems, typically those polluted by sewage (treated and untreated) inputs, have proven useful in examining both management of nutrient inputs and research questions related to species and community responses to pollution [61–63]. For example, numerous researchers have used elevated  $\delta^{15}\text{N}$  signatures of sewage effluent to map the distribution and impacts of sewage discharge on aquatic ecosystems and their biota [64–67]. In addition, the identification of patterns of movement between polluted and non-polluted environments using  $\delta^{15}\text{N}$  signatures, like that described in the case study presented in this document from Hadwen and Arthington [23], represents a relatively easy and effective way of investigating population and community dynamics.

#### **4.1. Current issues in stable isotope food web ecology**

Despite significant advancements in the use, interpretation and analysis of stable isotopes of carbon and nitrogen in food web studies over the past two decades, there remain some significant areas of ongoing research activity required to address uncertainties and limitations with these natural tracers, namely:

- (1) Trophic fractionation — the role of lab and field studies and apparent differences between systems and regions.
- (2) Challenging conceptual models of aquatic ecosystem functioning — global review of the role of algal (autochthonous) carbon in supporting consumer food webs.
- (3) Mixing model developments — making interpretation of stable isotope data more statistically rigorous.
- (4) Temporal and spatial variability, especially of algal sources, and how they confound assessments of food web structure and functioning.
- (5) Interpreting overlapping and/or highly depleted carbon sources.

### **5. CONCLUSIONS**

The stable isotopes of carbon and nitrogen can be used in food web studies to gain a better understanding of organic matter (energy) and nutrient (especially nitrogen) pathways through trophic interactions between organisms. The identification of these pathways has significant implications for the management and restoration of aquatic ecosystems, as efforts should be targeted to the challenge of restoring natural energy flows, even in heavily modified catchments. Ultimately, given the inherent links between carbon and nitrogen processing and nutrient dynamics within aquatic ecosystems, resource managers interested in managing nutrient loads in aquatic environments can use stable isotopes of carbon and nitrogen to guide them both in their decision making and monitoring of ecosystem responses to management interventions.

### **ACKNOWLEDGEMENTS**

We thank many colleagues for their field and laboratory contributions to the case studies presented in this paper.

## REFERENCES

- [1] JUNK, W.J., BAYLEY, P.B., SPARKS, R.E., “The flood-pulse concept in river-floodplain systems”, Proc. Int. Large River Symposium, LARS (DODGE, D.P., ed.), Canadian Special Publication in Fisheries and Aquatic Sciences **106** (1989) 110–127.
- [2] THORP, J.H., DELONG, M.D., GREENWOOD, K.S., CASPER, A.F., Isotopic analysis of three food web theories in constricted and floodplain regions of a large river, *Oecologia* **117** (1998) 551–563.
- [3] BUNN, S.E., DAVIES, P.M., WINNING, M., Sources of organic carbon supporting the food web of an arid zone floodplain river, *Freshwater Biol.* **48** 4 (2003) 619–635.
- [4] FRY, B., *Stable Isotope Ecology*, Springer, New York, USA (2006).
- [5] PETERSON, B.J. FRY, B., Stable isotopes in ecosystem studies, *Annual Review of Ecology and Systematics* **18** (1987) 293–320.
- [6] BUNN, S.E., “Riparian influences on ecosystem function in the Brisbane River”, Moreton Bay and Catchment (TIBBETTS, I.R., HALL, N.J., DENNISON, W.C., Eds), Brisbane: School of Marine Science, The University of Queensland (1998) 131–142.
- [7] FELLOWS, C.S., et al., Benthic metabolism as an indicator of stream ecosystem health, *Hydrobiologia* **572** (2006) 71–87.
- [8] UDY, J.W., et al., Measures of nutrient processes as indicators of stream ecosystem health. *Hydrobiologia* **572** (2006) 89–102.
- [9] FRANCE, R.L., Stable isotopic survey of the role of macrophytes in the carbon flow of aquatic foodwebs. *Vegetatio* **124** (1995) 67–72.
- [10] PETERSON, B.J., Stable isotopes as tracers of organic matter input and transfer in benthic food webs: A review, *Acta Oecologia* **20** (1999) 479–487.
- [11] POST, D.M., Using stable isotopes to estimate trophic position: Models, methods, and assumptions, *Ecology* **83** (2002) 703–718.
- [12] FRY, B., Stable isotope diagrams of freshwater food webs, *Ecology* **72** (1991) 2293–2297.
- [13] CABANA, G., RASMUSSEN, J.B., Modelling food chain structure and contaminant bioaccumulation using stable nitrogen isotopes, *Nature* **372** (1994) 255–257.
- [14] MINAGAWA, M., WADA, E., Stepwise enrichment of <sup>15</sup>N along food chains: Further evidence and the relation between  $\delta^{15}\text{N}$  and animal age, *Geochim. Cosmochim. Acta* **48** 5 (1984) 1135–1140.
- [15] McCUTCHAN, J.H., LEWIS, W.M.J., KENDALL, C., MCGRATH, C.C., Variation in trophic shift for stable isotope ratios of carbon, nitrogen and sulphur, *Oikos* **102** (2003) 378–390.
- [16] VANDERKLIFT, M.A., PONSARD, S., Sources of variation in consumer-diet  $\delta^{15}\text{N}$  enrichment: a meta-analysis, *Oecologia* **136** (2003) 169–182.

- [17] PINNEGAR, J.K., POLUNIN, N.V.C., Differential fractionation of  $\delta^{13}\text{C}$  and  $\delta^{15}\text{N}$  among fish tissues: implications for the study of trophic interactions, *Funct. Ecol.* **13** (1999) 225–231.
- [18] ADAMS, T.S., STERNER, R.W., The effect of dietary nitrogen content on trophic level  $^{15}\text{N}$  enrichment, *Limnol. Oceanogr.* **45** (2000) 601–607.
- [19] GAYE-SIESSEGGER, J., FOCKEN, U., MUETZEL, S., ABEL, H., BECKER, K., Feeding level and individual metabolic rate affect  $\delta^{13}\text{C}$  and  $\delta^{15}\text{N}$  values in carp: implications for food web studies, *Oecologia* **138** (2004) 175–183.
- [20] SWEETING, C.J., BARRY, J., BARNES, C., POLUNIN, N.V.C., JENNINGS, S., Effects of body size and environment on diet-tissue  $\delta^{15}\text{N}$  fractionation in fishes, *J. Exp. Mar. Biol. Ecol.* **340** (2007) 1–10.
- [21] McKEE, K.L., FELLER, I.C., POPP, M., WANEK, W., Mangrove isotopic ( $\delta^{15}\text{N}$  and  $\delta^{13}\text{C}$ ) fractionation across a nitrogen vs phosphorus limitation gradient, *Ecology* **83** (2002) 1065–1075.
- [22] HANSSON, S., HOBBIE, J.E., ELMGREN, R., LARSSON, U., FRY, B., JOHANSSON, S., The stable nitrogen isotope ratio as a marker of food-web interactions and fish migration, *Ecology* **78** (1997) 2249–2257.
- [23] HADWEN, W.L., ARTHINGTON, A.H., Food webs of two intermittently open estuaries receiving  $^{15}\text{N}$ -enriched sewage effluent, *Estuar. Coast. Shelf Sci.* **71** (2007) 347–358.
- [24] HADWEN, W.L., BUNN, S.E., Tourists increase the contribution of autochthonous carbon to littoral zone food webs in oligotrophic dune lakes, *Mar. Freshw. Res.* **55** (2004) 701–708.
- [25] WINNING, M.A., CONNOLLY, R.M., LONERGAN, N.R., BUNN, S.E.,  $^{15}\text{N}$  enrichment as a method of separating the isotopic signatures of seagrass and its epiphytes for food web analysis, *Mar. Ecol. Progr. Ser.* **189** (1999) 289–294.
- [26] HADWEN, W.L., BUNN, S.E., Food web responses to low-level nutrient and  $^{15}\text{N}$ -tracer additions in the littoral zone of an oligotrophic dune lake, *Limnol. Oceanogr.* **50** (2005) 1096–1105.
- [27] HADWEN, W.L., RUSSELL, G.L., ARTHINGTON, A.H., Gut content- and stable isotope-derived diets of four commercially and recreationally important fish species in two intermittently open estuaries, *Mar. Freshw. Res.* **58** (2007) 363–375.
- [28] CREACH, V., SCHRICKE, M.T., BERTRU, G., MARIOTTI, A., Stable isotopes and gut analyses to determine feeding relationships in saltmarsh macroconsumers, *Estuar. Coast. Shelf Sci.* **4** (1997) 599–611.
- [29] GREY, J., THACKERAY, S.J., JONES, R.I., SHINE, A., Ferox trout (*Salmo trutta*) as ‘Russian dolls’: complementary gut content and stable isotope analyses of the Loch Ness foodweb, *Freshw. Biol.* **47** (2002) 1235–1243.
- [30] JONES, J.I., WALDRON, S., Combined stable isotope and gut contents analysis of food webs in plant-dominated, shallow lakes, *Freshw. Biol.* **48** (2003) 1396–1407.



- [31] YATSUYA, K., NAKAHARA, H., Diet and stable isotope ratios of gut contents and gonad of the sea urchin *Anthocidaris crassispina* (A. Agassiz) in two different adjacent habitats, the Sargassum area and Corallina area, *Fish. Sci.* **70** (2004) 285–292.
- [32] AXLER, R.P., REUTER, J.E., Nitrate uptake by phytoplankton and periphyton: Whole-lake enrichments and mesocosm  $^{15}\text{N}$  experiments in an oligotrophic lake, *Limnol. Oceanogr.* **41** (1996) 659–671.
- [33] MULHOLLAND, P.J., et al., Food resources of stream macroinvertebrates determined by natural-abundance stable C and N isotopes and a  $^{15}\text{N}$  tracer addition, *J. N. Am. Benthol. Soc.* **19** (2000) 145–157.
- [34] MULHOLLAND, P.J., et al., Nitrogen cycling in a forest stream determined by a  $^{15}\text{N}$  tracer addition, *Ecol. Monogr.* **70** (2000) 471–493.
- [35] HADWEN, W.L., ARTHINGTON, A.H., MOSISCH, T.D., The impact of tourism on dune lakes on Fraser Island, Australia, *Lakes and Reservoirs: Research and Management* **8** (2003) 15–26.
- [36] HADWEN, W.L., BUNN, S.E., ARTHINGTON, A.H., MOSISCH, T.D., Within-lake detection of the effects of tourist activities in the littoral zone of oligotrophic dune lakes, *Aquat. Ecosys. Health Manage.* **8** (2005) 159–173.
- [37] RIERA, P., STAL, L.J., NIEUWENHUIZE, J., Heavy  $\delta^{15}\text{N}$  in intertidal benthic algae and invertebrates in the Scheldt Estuary (The Netherlands): Effect of river nitrogen inputs, *Estuar. Coast. Shelf Sci.* **51** (2000) 365–372.
- [38] WAYLAND, M., HOBSON, K.A., Stable carbon, nitrogen, and sulphur isotope ratios in riparian food webs on rivers receiving sewage and pulp-mill effluents, *Can. J. Zool.* **79** (2001) 5–15.
- [39] GARTNER, A., LAVERY, P., SMIT, A.J., Use of  $\delta^{15}\text{N}$  signatures of different functional forms of macroalgae and filter-feeders to reveal temporal and spatial patterns in sewage dispersal, *Mar. Ecol. Progr. Ser.* **235** (2002) 63–73.
- [40] DEBRUYN, A.M.H., MARCOGLIESE, D.J., RASMUSSEN, J.B., The role of sewage in a large river food web. *Can. J. Fish. Aquat. Sci.* **60** (2003) 1332–1344.
- [41] FRY, B., Conservative mixing of stable isotopes across estuarine salinity gradients: A conceptual framework for monitoring watershed influences on downstream fisheries production, *Estuaries* **25** (2002) 264–271.
- [42] BOON, P.I., BUNN, S.E., Variations in the stable isotope composition of aquatic plants and their implications for food web analysis, *Aquat. Botany* **48** (1994) 99–108.
- [43] PHILLIPS, D.L., Mixing models in analyses of diet using multiple stable isotopes: a critique, *Oecologia* **127** (2001) 166–170.
- [44] PHILLIPS, D.L., KOCH, P.L., Incorporating concentration dependence in stable isotope mixing models, *Oecologia* **130** (2002) 114–125.
- [45] PHILLIPS, D.L., GREGG, J.W., Uncertainty in source partitioning using stable isotopes, *Oecologia* **127** (2001) 171–179.

- [46] PHILLIPS, D.L., NEWSOME, S.D., GREGG, J.W., Combining sources in stable isotope mixing models: alternative methods, *Oecologia* **144** (2005) 520–527.
- [47] PHILLIPS, D.L., GREGG, J.W., Source partitioning using stable isotopes: coping with too many sources, *Oecologia* **136** (2003) 261–269.
- [48] CONNOLLY, R.M., GUEST, M.A., MELVILLE, A.J., OAKES, J.M., Sulphur stable isotopes separate producers in marine food-web analysis, *Oecologia* **138** (2004) 161–167.
- [49] BENSTEAD, J.P., MARCH, J.G., FRY, B., EWEL, K.C., PRINGLE, C.M., Testing IsoSource: Stable isotope analysis of a tropical fishery with diverse organic matter sources, *Ecology* **87** (2006) 326–333.
- [50] CONNOLLY, R.M., HINDELL, J.S., GORMAN, D., Seagrass and epiphytic algae support nutrition of a fisheries species, *Sillago schomburgkii*, in adjacent intertidal habitats. *Mar. Ecol. Progr. Ser.* **286** (2005) 69–76.
- [51] HAMILTON, S.K., LEWIS, W.M.J., SIPPEL, S.J., Energy sources for aquatic animals in the Orinoco River floodplain: evidence from stable isotopes, *Oecologia* **89** (1992) 324–330.
- [52] BUNN, S.E., BOON, P.I., What sources of organic carbon drive food webs in billabongs? A study based on stable isotope analysis, *Oecologia* **96** (1993) 85–94.
- [53] MULHOLLAND, P. J., et al., Food resources of stream macroinvertebrates determined by natural-abundance stable C and N isotopes and a  $^{15}\text{N}$  tracer addition, *J. N. Am. Benthol. Soc.* **19** 1 (2000) 145–157.
- [54] MULHOLLAND, P.J., et al., Nitrogen cycling in a forest stream determined by a  $^{15}\text{N}$  tracer addition, *Ecol. Monographs* **70** 3 (2000) 471–493.
- [55] RYBCZYNSKI, S.M., WALTERS, D.M., FRITZ, K.M., JOHNSON, B.R., Comparing trophic position of stream fishes using stable isotope and gut contents analyses, *Ecology of Freshwater Fish* **1–8** (2007).
- [56] SWEETING, C.J., POLUNIN, N.V.C., JENNINGS, S., Effects of chemical lipid extraction and arithmetic lipid correction on stable isotope ratios of fish tissues, *Rapid Commun. Mass Spectrom.* **20** (2006) 595–601.
- [57] YOKOYAMA, H., et al., Variability of diet-tissue isotopic fractionation in estuarine macrobenthos, *Mar. Ecology Progr. Ser.* **296** (2005) 115–128.
- [58] DOUGLAS, M.M., BUNN, S.E., DAVIES, P.M., River and wetland food webs in Australia's wet-dry tropics: general principles and implications for management, *Mar. Freshw. Res.* **56** (2005) 329–342.
- [59] VANNOTE, R.L., MINSHALL, G.W., CUMMINS, K.W., SEDELL, J.R., CUSHING, C.E., The river continuum concept, *Can. J. Fish. Aquat. Sci.* **37** (1980) 130–137.
- [60] THORP, J.H., DELONG, M.D., The riverine productivity model: an heuristic view of carbon sources and organic processing in large river ecosystems, *Oikos* **70** (1994) 305–308.

- [61] RISK, M.J., ERDMANN, M.V., Isotopic composition of nitrogen in Stomatopod (Crustacea) tissues as an indicator of human sewage impacts on Indonesian coral reefs, *Mar. Pollut. Bull.* **40** (2000) 50–58.
- [62] LAKE, J.L., et al., Stable nitrogen isotopes as indicators of anthropogenic activities in small freshwater systems, *Can. J. Fish. Aquat. Sci.* **58** (2001) 870–878.
- [63] SCHLACHER, T.A., LIDDELL, B., GASTON, T.F., SCHLACHER-HOENLINGER, M., Fish track wastewater pollution to estuaries, *Oecologia* **144** (2005) 570–584.
- [64] COSTANZO, S.D., O'DONOHUE, M.J., DENNISON, W.C., LONERAGAN, N.R., THOMAS, M., A new approach for detecting and mapping sewage impacts, *Mar. Pollut. Bull.* **42** (2001) 149–156.
- [65] WALDRON, S., TATNER, P., JACK, I., ARNOTT, C. The impact of sewage discharge in a marine embayment: A stable isotope reconnaissance, *Estuar. Coast. Shelf Sci.* **52** (2001) 111–115.
- [66] UMEZAWA, Y., MIYAJIMA, T., YAMAMURO, M., KAYANNE, H., KOIKE, I., Fine-scale mapping of land-derived nitrogen in coral reefs by  $\delta^{15}\text{N}$  in macroalgae, *Limnol. Oceanogr.* **47** (2002) 1405–1416.
- [67] YAMAMURO, M., KAYANNE, H., YAMANO, H.,  $\delta^{15}\text{N}$  of seagrass leaves for monitoring anthropogenic nutrient increases in coral reef ecosystems, *Mar. Pollut. Bull.* **46** (2003) 452–458.

# USING STABLE ISOTOPES TO DETECT LAND USE CHANGE AND NITROGEN SOURCES IN AQUATIC SYSTEMS

K.M. ROGERS

National Isotope Center,  
GNS Science,  
Lower Hutt, New Zealand

## Abstract

Changing land use is one of the primary causes of increased sedimentation and nutrient levels in aquatic systems, resulting in contamination and reduction of biodiversity. Detecting and quantifying these inputs is the first step towards remediation, and enabling targeted reductions of transport processes into waterways from human impacted land surfaces. More recently, stable isotope analyses are being used as detection and quantification tools in aquatic environments. Carbon ( $\delta^{13}\text{C}$ ) and nitrogen ( $\delta^{15}\text{N}$ ) isotopes of sediments, as well as algae and invertebrates from aquatic systems can be used as proxies to record both short and long term environmental change. Excess nitrogen (or nitrogen-compounds) derived from urbanization, industry, forestry, farming and agriculture, increase the bioavailability of nitrogen to aquatic organisms, changing their natural  $\delta^{15}\text{N}$  isotopic signatures. Allochthonous (terrestrial) input from soil destabilization and human activity in surrounding catchments changes  $\delta^{13}\text{C}$  isotopic compositions and increases the C:N ratio of sediments. Heavy metal and other organic pollutants can also be used to indicate urbanization and industrial contamination. The combined use of carbon and nitrogen isotopes, C:N ratios and heavy metals are powerful environmental monitoring tools, which are useful indicators of source and transport pathways of terrestrial derived material and anthropogenic pollutants into streams, rivers and estuaries.

## 1. INTRODUCTION

Expanding human populations and various human activities have significantly increased the biologically available supply of nitrogen and carbon in the environment. Discerning the source signatures of carbon and nitrogen can therefore be an important tool in the assignment and apportioning of these elements between natural and pollutant origins [1, 2]. Their characterization and fate can be followed using stable isotope techniques [3–7] which not only determine the origin of the contribution but assist in quantifying these inputs. Two main sources of organic input exist in aquatic systems: (1) autochthonous (aquatic derived) organic matter such as phytoplankton and algae; and (2) allochthonous (terrestrial or human derived) organic matter.

The impacts of excess allochthonous input into aquatic systems include eutrophication, biodiversity changes and the direct toxic effects of nitrogen compounds and heavy metals on aquatic and terrestrial organisms, as well as humans. Excess nitrogen (or nitrogen compounds), soil (SOM) and particulate organic matter (POM) in waterways usually manifest as increasing turbidity, discoloration, foaming, odour, algae blooms and contaminated fish. They also affect drinking water quality due to a high amount of suspended solids and increased levels of nitrates and other contaminants, which affect the taste and odour of the water.

Eutrophication affects lakes and estuaries, and can even slow moving rivers by restricting flow. It is caused by the excess allochthonous input of organic matter and/or sediment via erosion, which can directly smother fragile aquatic environments, leading to trophic food web imbalances and biodiversity loss (including changes or loss in the types of bottom dwelling

organisms and/or an increase in opportunistic species such as invasive algae etc). Nitrogen compounds derived from allochthonous inputs, such as animal and human waste, or nitrates from fertilizing agricultural or farmland can be transported directly into aquatic systems. These nitrogen compounds will over-stimulate the autochthonous production of plant biomass (eutrophication), resulting in subsequent oxygen consumption during decomposition and reduced biodiversity. Agriculture and urbanization also contribute heavy metals, which can bioaccumulate in macro fauna, passing through the food web into humans. Heavy metal analysis is often used as a complimentary method to isotope analysis in detecting human impacts, especially urbanization and industrial activities.

Inevitably, rivers, lakes and estuaries are the main collectors of soil and organic matter from terrestrial and contaminant derived systems. Due to changing land use, and conversion of forested areas to urban zones, farming, agriculture and commercial forestry, especially over the last 50 years, these waterways are becoming increasingly compromised. In this paper, the effects of catchment land use and nitrogen sources on sediments, algae and benthic invertebrates from two estuaries (Pauatahanui Inlet and Porirua Harbour, New Zealand) are determined, using stable isotope data and heavy metal concentrations.

## **2. WHAT ARE THE PRINCIPAL SOURCES OF ALLOCHTHONOUS INPUTS?**

Principal sources of contaminants include nutrients (or nitrogen compounds) (2.1.), organic matters (2.2), heavy metals (2.3) and other contaminants such as hydrocarbons and pesticides (2.4).

### **2.1. Nitrogen derived nutrients**

The oversaturation of ecosystems with nitrogen (through, for example, over-fertilization in agricultural practices) can lead to high rates of nitrogen transfer into surface waters and/or groundwater. While the dominant pathway of loss is normally nitrate leaching, a number of pathways including atmospheric transport and catchment runoff are also common.

#### **2.1.1. Natural sources**

Nutrients are naturally present in the environment and occur in both organic and inorganic forms. Natural organic nitrogen sources are derived from leaves and organic debris from riparian zones and *in situ* faecal matter, as well as aquatic debris in waterways. Natural dissolved inorganic nitrogen (DIN) is primarily derived from nitrification and denitrification, and is found in the form of nitrate ( $\text{NO}_3^-$ ) and ammonia ( $\text{NH}_4^+$ ), which typically sustains planktonic and benthic primary production [8].

#### **2.1.2. Municipal and rural wastewater**

Unless wastewater is tertiary treated, or treated to remove nutrients, municipal wastewater is one of the largest point sources of nitrogen released to lakes, rivers, and coastal waters. However, many communities worldwide are still served by primary treatment or none at all, with too many populations still reliant on septic systems, which often release sewage directly into the ground. If these nutrients cannot be assimilated by the receiving land, they leach into waterways and groundwater.

### ***2.1.3. Urbanization***

Preparation of land for building homes and industries releases nutrients via wind and water erosion, and transportation of soil. If adequate sediment traps are not maintained, large volumes of terrestrial material can be transported into aquatic systems, affecting biodiversity and contributing to eutrophication.

### ***2.1.4. Industrial discharges***

Most light industries discharge their wastewater into municipal sewage systems for treatment at municipal wastewater treatment plants, though in the past, discharge often occurred directly into waterways. Industrial discharge often contains excess quantities of heavy metals from by-products and processing, and many waterways have historical heavy metal contamination which can be resuspended during large flows of water such as during flood and storm events.

### ***2.1.5. Agriculture***

Nitrogen, in the form of synthetic chemical fertilizers and organic manure, is applied to agricultural land to increase crop yields. Total nitrogen compound additions (fertilizer, manure, nitrogen fixation by legumes, atmospheric deposition, application of sewage sludges, etc.) to agricultural land are substantially offset by crop uptake and the production of harvested commodities. However in many cases, over-fertilization of agricultural land is problematic and total applied nitrogen exceeds uptake.

### ***2.1.6. Farming***

Soil erosion and transportation readily occurs from land with poor grass coverage, or which is overgrazed due to intensive livestock farming. Poor fencing near rivers and streams results in livestock damage of fragile riparian zones. Contamination of waterways occurs with the addition of animal effluent, increasing erosion and lowering nutrient retention, contributing to algal blooms and biodiversity changes.

### ***2.1.7. Forestry***

Forested catchments contribute much of the water that enters streams, rivers and lakes. Forest management practices may increase concentrations of nitrogen compounds in stream water due to fertilization of trees and decomposition of tree waste. Concurrently, deforestation increases the supply of sediments and nutrients to stream and rivers via erosion and sediment transport from destabilized catchments.

### ***2.1.8. Emissions to the atmosphere and atmospheric deposition***

Various forms of nitrogen are emitted to the atmosphere via the agricultural sector, as well as through fossil fuel combustion for transportation and industry (combustion related emissions and industrial processes). Much of the nitrogen released into the atmosphere is redeposited on the ground or in water. Atmospheric deposition of nitrogen compounds contributes to both eutrophication and acidification of surface waters. Insoluble hydrocarbon residues from incomplete combustion of fossil fuels such as soot and PAHs can also build up in ecosystems, and some organic compounds and heavy metals bioaccumulate in food webs.



## 2.2. Organic matter (OM)

Soil and particulate organic matter is composed of allochthonous (transported) terrestrial and autochthonous (in situ) aquatic materials, which are a significant source of nitrogen to rivers, lakes and coastal marine ecosystems. In many cases, the levels are appropriate for sustaining biodiversity in the aquatic environment. In cases where nitrogen input exceeds demand, adverse effects occur. Isotopic values and heavy metal concentrations of SOM and POM also provide a detailed and integrated record of natural and anthropogenic activities within a basin's catchment [1, 9, 10].

Terrestrial sources of OM include:

- Fresh terrestrial plant detritus;
- Soil and suspended particulate organic material (SOM and POM);
- Anthropogenic organic matter from urban, industry, farming or agriculture (i.e. inorganic fertilizers or animal manure).

Aquatic sources of OM include:

- Phytoplankton;
- Faecal material from aquatic organisms;
- Aquatic plants (algae and macrophytes).

## 2.3. Heavy metals

Heavy metals, derived naturally from geological formations or anthropogenically introduced, enter lakes and estuaries via rivers, streams, storm water drains or simple leaching from sediments. These metals are retained in sediments, and are available to shellfish and other bottom feeders, resulting in bioaccumulation. Heavy metal concentrations are usually highest in subtidal basins where fine sediments accumulate, as they readily bind to finer sediments. Macro fauna found in these sediments often bioaccumulate heavy metals over time, especially in benthic invertebrates such as grazers or filter feeders, which ingest contaminated sediments [11, 12]. Further contamination can occur during extreme events such as flooding and erosion which resuspend sediments containing heavy metals from river beds and floodplains. They can then be redeposited over areas of agricultural use or human habitation, rendering an area contaminated and unsuitable for crops, farming or human habitation.

Urbanization contributes heavy metals, such as copper, lead and zinc, which tend to be derived from roofing (unpainted galvanized roofs), plumbing and vehicle brake pad wear. Architectural uses (such as copper spouting) and vehicle tire wear are also key secondary sources of copper and zinc. Although lead petrol is no longer available in New Zealand, historic accumulations in roadside soils exist, and drainage from these soils and road surfaces can be washed into the catchments from urbanized areas and accumulate in both sediments and shellfish [13]. Lead sources can also be remobilized from older residential areas where soils are known to be contaminated with lead based paint residues. Further toxic metals from industrial processes include mercury, cadmium and arsenic, while boat mooring areas often show higher levels of chromium and arsenic from anti-fouling agents used to deter algal growth on boat hulls. In excess, all these metals are toxic to humans and can cause serious medical illness.

Heavy metal leaching through acid rain is another common way to introduce heavy metals into the environment. Industrial emissions such as sulphur dioxide and nitrous oxides can react with water vapour in the atmosphere to generate acidic rain. Depending on the geology of sediments, leaching of significant amounts of metals such as calcium, aluminium, iron, and nickel can occur. Heavy metals are absorbed by clays in surface muds and build up year by year.

#### **2.4. Other contaminants**

Contaminants such as hydrocarbons and soot from vehicle emissions and other toxic materials such as paint, pesticides and household chemicals enter urban storm water drains, which flow into streams and rivers. These pollutants poison the waterways and reduce biodiversity. They kill insects, snails and worms in streams, encourage weeds to grow, reduce oxygen levels in the water, suffocate shellfish, fish and other organisms, accumulate in sediments and spoil the recreational values of streams and the estuaries.

Often unacceptable levels of faecal coliform and enterococcal pollution occur in shellfish, making them unfit for human consumption. These are indicator organisms for human or animal faeces that the shellfish have filtered and ingested from a water column. Elevated levels of total polycyclic aromatic hydrocarbons (TPAHs) can occur in sediments and shellfish [14], mainly from accumulation of compounds derived from incomplete combustion of coal, wood, motor vehicle fuels and oil spills [15]. Organochlorines, derived from pesticides such as DDT, are released on farms and horticultural sites. They are long lasting in muds and in the bodies of organisms. They are fat soluble rather than water soluble, hence they are not released by normal excretory processes which depend on the flushing effect of water. They accumulate progressively around urban centres [16], and can be toxic and carcinogenic.

### **3. THE USE OF STABLE ISOTOPES TO DETECT LANDUSE CONTRIBUTION**

Stable carbon isotope ratios are useful to estimate the relative contributions of terrestrial derived carbon and *in situ* sources of carbon from aquatic POM (especially in marine environments), as various sources often have distinctive isotopic compositions. However, an overlap of the  $\delta^{13}\text{C}$  ranges for each source can occur, which can make quantification of terrestrial versus aquatic contributions difficult based on  $\delta^{13}\text{C}$  alone [2, 5, 10, 17, 18]. More commonly,  $\delta^{15}\text{N}$  and C/N ratios are used concurrently with C isotopes to differentiate more clearly between anthropogenic and natural sources, and aquatic and terrestrial sources [10, 19–22].

#### **3.1. Using stable isotope analysis to determine autochthonous sources**

The stable isotopic composition of sediments and various types of POM found in rivers, lakes and estuaries (Table 1, Fig. 1) reflects the proportion of transported terrestrial organic matter (allochthonous OM; primarily  $\text{C}_3$  plant detritus and  $\text{C}_3$  plant dominated soils) and *in situ* organic matter (autochthonous OM; primarily phytoplankton, algae, aquatic and macrophytes) [23]. However care must be taken as both types of organic contributions can further be affected by fractionation processes during assimilation of nutrients and/or contaminants, which can change their isotopic signatures. Biodegradation of organic matter can also affect their isotopic signature and elemental composition [24–25].

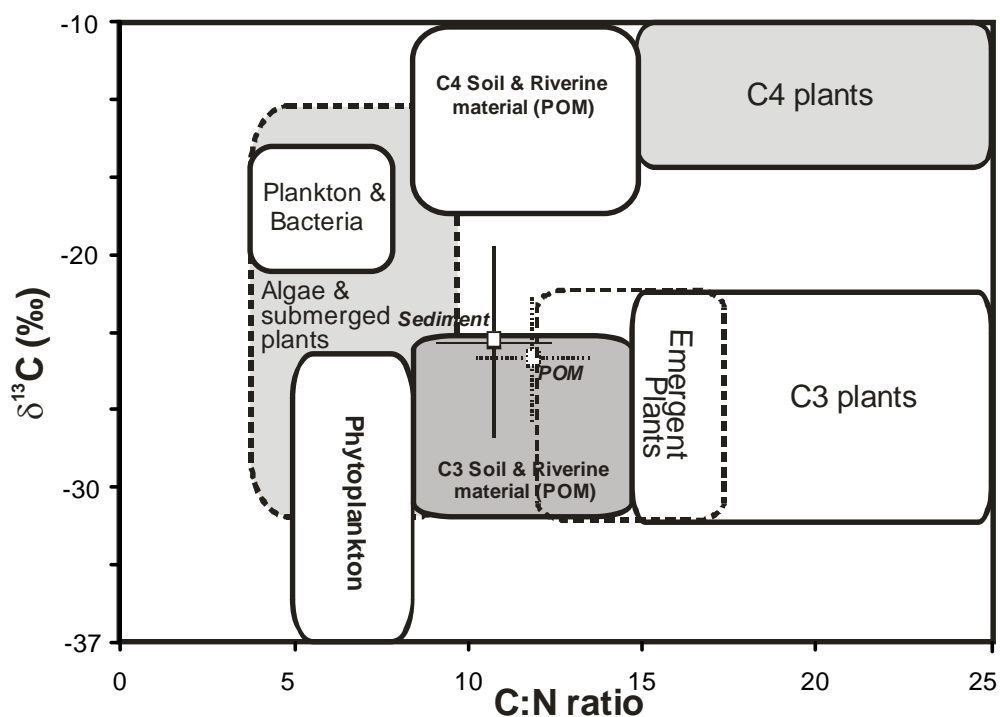

FIG. 1. The  $\delta^{13}\text{C}$  and C:N values of various types of terrestrial and aquatic organic matter (see also Table 1) overlaid by the range of sediment and POM values from Porirua Harbour and Pauatahanui Inlet (see also Table 2).

TABLE 1. AVERAGE VALUES OF ORGANIC SOURCES IN AQUATIC SYSTEMS; NORMAL RANGES ARE INCLUDED IN PARENTHESES

OM Source	Type	$\delta^{13}\text{C}$ (‰)	$\delta^{15}\text{N}$ (‰)	C:N ratio (at)	References
Phytoplankton/ Algae		-32 to -23 (-42 to -19)	? (-15 to +20)	5 to 8	[8, 19, 26-29]
	Macrophytes	-27 to -20 (-28 to -18)	? (-15 to +20)	10 to >50 (8 to >80)	
Soil Organic Matter	C3	-27 -32 to -22)	+0 to +5	8 to >25	[10, 19, 29]
	C4	-13 (-16 to -9)	+0 to +5	8 to >25	
Terrestrial Plants	C3	-26 to -27 (-32 to -22)	+3 to +7 (-10 to +10)	>15 (15 to >50)	[10, 19]
	C4	-13 (-16 to -9)	+3 to +7 (-10 to +10)	>15 (15 to >50)	

TABLE 2. ISOTOPIC, ELEMENTAL AND MIXING MODEL EVALUATIONS OF SEDIMENTS FROM PORIRUA HARBOUR AND PAUATAHANUI INLET

Sampling site	$\delta^{13}\text{C}$ POM	C:N (atm) POM	%Allochthonous contribution to POM	$\delta^{13}\text{C}$ Sediments	C:N (atm) Sediments	%Allochthonous contribution to sediments
P1	-27.8	12.3	0.9	-27.4	11.3	0.9
P2	-26.3	13.3	0.8	-26.3	12.3	0.8
P3	-26.3	12.1	0.8	-28.5	12.3	1.0
P4	-25.8	13.9	0.7	-22.3	13.2	0.3
P5	-22.9	12.3	0.4	-22.3	13.4	0.3
P6	-24.2	10.8	0.6	-21.9	11.7	0.3
P7	-23.2	10.7	0.5	-20.5	10.0	0.2
P8	-22.8	10.1	0.4	-20.4	8.6	0.1
P9	-25.8	11.1	0.7	-24.2	9.9	0.5
P10	-22.7	12.9	0.4	-22.0	8.3	0.3
S1	-18.6	11.7	0.0	-18.9	10.1	0.0
S2	-26.1	8.9	0.8	-19.8	9.7	0.1
S3	-27.2	8.9	0.9	No data	No data	No data
S4	-25.1	14.6	0.7	-25.3	10.5	0.7
S5	-24.1	13.3	0.6	-24.7	12.1	0.6
S6	-22.0	11.7	0.3	-19.8	11.2	0.1
S7	-24.7	13.0	0.6	-20.5	9.5	0.2
S8	-21.3	10.7	0.3	-21.8	11.4	0.3
S9	-20.0	12.6	0.1	-20.2	13.0	0.1

Most modern isotope mass spectrometers measure both carbon and nitrogen contents (%C and %N) concurrently with their isotopic abundance. C/N (atomic) ratios [where  $C/N = (\%C/\%N) / (14/12)$ ] vary, depending on the terrestrial or aquatic nature of the contributing material. Terrestrial plants have a higher ratio of C/N ( $> +15$ ) due to abundant carbon ring structures such as resins, lignin and cellulose (which gives plants their unique rigidity and strength). There is proportionally lower nitrogen content in these plants. Aquatic plants (phytoplankton, algae and macrophytes) generally have a lower C/N ratio than terrestrial plants. Water tends to give these more fragile plants much of their support, and they tend to have fewer carbons ring structures, being dominated by longer chain molecules, such as chlorophyll and lipids.

Aquatic plants have complex isotope signatures due to their range of soluble nutrients, including dissolved inorganic nitrogen and nitrogen fixing [10, 26]. Assimilation of  $^{13}\text{C}$  and  $^{15}\text{N}$  depends on diffusion rates of dissolved inorganic carbon and nitrogen (DIC and DIN), but C isotopic compositions also depend on relative exposure of plants to atmospheric  $\text{CO}_2$  (during periods of low water levels) versus DIC (during periods of submersion) [10].

Phytoplankton and macrophytes receive most of their carbon from dissolved inorganic carbon (DIC) [30], as they are fully submerged and do not respire atmospheric CO<sub>2</sub>. DIC has a δ<sup>13</sup>C composition near 0‰ for waters with pH > 7. However, the addition of respired CO<sub>2</sub> from plant sources (δ<sup>13</sup>C = -27‰ for C<sub>3</sub> plants) or methane produced from anoxic sediments can lower the δ<sup>13</sup>C of DIC [31]. Fractionation during CO<sub>2</sub> assimilation and photosynthesis of phytoplankton depends on several factors such as aqueous CO<sub>2</sub> concentration, diffusion rate, growth rate, temperature and mixing, hence in summer when primary production is highest, the available C and N is consumed more rapidly [10]. Correspondingly, δ<sup>13</sup>C and δ<sup>15</sup>N values may increase. Phytoplankton has δ<sup>13</sup>C values of between -42 to -24‰, with an average of around -30‰ [32–33]. The C:N ratios are usually in the range of 5 to 8. Macrophytes have δ<sup>13</sup>C values between -28 to -18‰ and C/N ratios of around 11 to 12. Aquatic plants and phytoplankton have δ<sup>15</sup>N values which are less predictable due to the large range of DIN found in aquatic systems. In general they are estimated to have δ<sup>15</sup>N values of between -15 to 20‰ [10]. The C:N ratios of benthic algae are usually in the range of 8–10 [26].

Terrestrial plants use atmospheric CO<sub>2</sub> as their carbon source, which has shifted from -7 to -8.5‰ in rural environments, down to as low as -14‰ in anthropised areas during the last century due to human activities [34–36]. Most terrestrial plants fall into three main groups which have different photosynthetic pathways: C<sub>4</sub> plants consist of corn, sugar cane and warm season grasses and convert atmospheric CO<sub>2</sub> into a chemical compound with four carbon atoms, and they absorb <sup>13</sup>C faster than <sup>12</sup>C, so the total biomass of C<sub>4</sub> plants has δ<sup>13</sup>C values ranging between -9 to -16‰ [30, 37, 38]. Meanwhile, C<sub>3</sub> plants are far more abundant than C<sub>4</sub> plants and consist of trees and other woody vegetation, as well as cool season grasses. They convert atmospheric CO<sub>2</sub> into a chemical compound with three carbon atoms, and are slower to absorb <sup>13</sup>C than <sup>12</sup>C, so their total biomass δ<sup>13</sup>C values range between -22 to -35‰ [39]. The third plant group is called CAM for Crassulacean acid metabolism, which can use either pathway for photosynthesis, and which have values similar to C<sub>3</sub> or C<sub>4</sub> plants [40]. These plants are usually succulents or cacti found in arid regions and not considered in this paper. It should be noted that C<sub>4</sub> contributions are the most isotopically positive carbon source which could contribute to POM.

Nitrogen isotopes (δ<sup>15</sup>N) are also dependent on plant type, as N-fixing plants (such as legumes and some grasses) assimilate atmospheric N directly, while non-N fixing plants assimilate ammonium or nitrate from the soil. Hubner (1986) [41] noted that assimilation and N-fixing do not alter original isotopic signature significantly, resulting in δ<sup>15</sup>N of plants which are a few per mil lower than the source of nitrogen. However, non-N fixing plants are dependent on nitrogen sources which are easily volatilized, nitrified and denitrified, resulting in often large differences between the δ<sup>15</sup>N of plants and its original source.

### **3.2. Using stable isotope analysis to determine allochthonous sources**

Erosion (transportation of sediments) and catchment drainage are the primary pathways of anthropogenic transfer of solids and liquids into aquatic environments such as streams, rivers, lakes and estuaries [27, 42, 43]. Linking these various land use influences to aquatic systems can be as simple as following heavy and trace metals from the contaminated source to its resting point by analysing sediment or water samples, or it can be as complicated as establishing groundwater residence times and age dating samples to estimate when contaminants will appear.

River and lake systems both receive allochthonous substances and produce autochthonous organic matter, both of which are metabolized and recycled. Lakes, however, are generally closed systems (although some lakes could be classified almost as flow-through systems), that store inorganic and organic matter. They circulate organic matter and dissolved inorganic substances in the lake basin and eventually deposit them into the bottom sediments. Rivers are open systems that transport water and dissolved and suspended matter from the continents to estuaries or the sea. This transport may include intermediate deposition and re-suspension of sediments in the river channel or in the connected floodplain, where production and degradation of organic matter can also take place [44].

Soil organic matter (SOM) reflects the type of plants growing on them, depending on whether the plant is  $C_3$  ( $\delta^{13}C \sim -27\text{‰}$ ) or  $C_4$  ( $\delta^{13}C \sim -13\text{‰}$ ). Most soils have  $\delta^{15}N$  values between +0 and +10‰, with an average around +5‰ [45, 46]. Soil C:N ratios in the top soil (top 15 cm) are usually between 10 to 12, however ratios tend to be higher in more humid areas, during storm events [47] and higher in colder areas [48]. Soil micro-organisms have lower C:N ratios of between 4 and 9. Soil OM is derived from terrestrial debris, but C:N ratios are much lower for soils than terrestrial plants due to the breakdown of plant material by micro-organisms [25].

Allochthonous nutrients are derived primarily from anthropogenic sources outlined in section 2.1.2 to 2.1.8. In most cases synthetic nitrogen can be distinguished from animal or human waste, as synthetic fertilizers are industrially derived from nitrogen extracted from air with a  $\delta^{15}N$  value of around 0‰, while animal or human wastes usually have higher  $\delta^{15}N$  values, ranging from 5 to 20‰ [46, 49–51].

## 4. A CASE STUDY

In 2004, surface sediments, benthic filter feeders (common cockle — *Austrovenus stutchburyi*), benthic deposit grazers (mud snail — *Amphibola crenata*), and macro algae (*Ulva lactuca* and *Gracilaria secundata*) were collected from sites around the Porirua Harbour and Pauatahanui Inlet, near Wellington, New Zealand (Fig. 2). The two estuaries serve as transition zones between sea and fresh water outlets such as streams and storm water drains, with all but the finest particles settling within a short distance of each outlet [52]. The isotopic composition of sediments, cockles, mud snails, *Ulva* and *Gracilaria*, combined with other geochemical evaluations such as %C, %N, C:N ratios, heavy metals and organic pollutants were investigated to detect land use change around the estuaries. Short and long term proxies were developed to assess the suitability of sediments, cockles and *Ulva* as in situ indicators of allochthonous nutrient input and sediment transportation.

### 4.1. Methods

#### 4.1.1. Study site

The area comprises two large estuaries, of which the Pauatahanui Inlet has a surface area of 4.5 km<sup>2</sup> and is encircled by a main road bordered by housing around one half and farming/forestry around the other. The Inlet has a catchment area of 109 km<sup>2</sup>, consisting of 54% pasture, 4% urban, and 42% forest and bush cover [53]. Porirua Harbour has a surface area of 4 km<sup>2</sup> and is extensively modified by urbanization [54], industrialization and partially bordered by a motorway and train tracks. Porirua Harbour has a catchment area of 55.38 km<sup>2</sup>, consisting of 38%



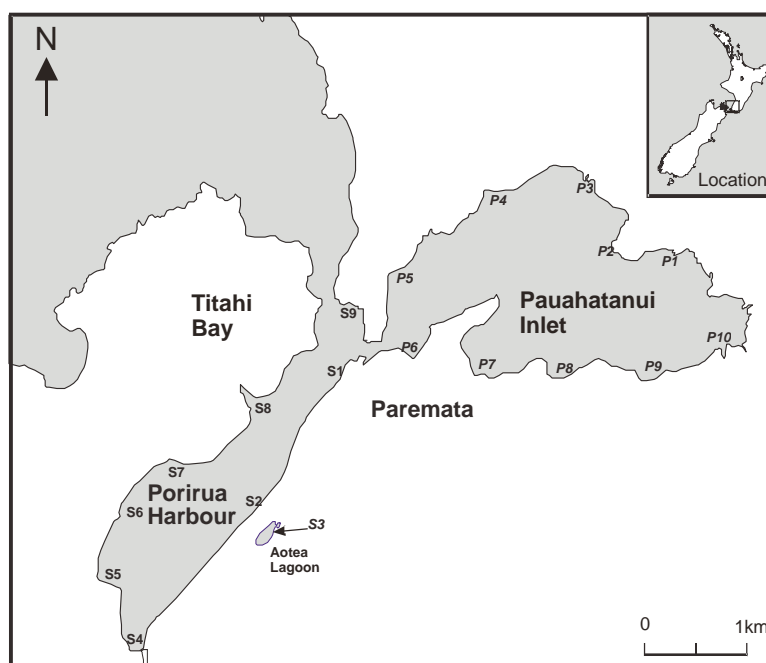

FIG. 2. Sampling sites around Pauahatanui Inlet and Porirua Harbour, New Zealand. Streams or storm water pipes drain into the catchment at each sample site.

pasture, 33% urban, and 29% forest and bush cover [13]. Eighteen sites from inter-tidal estuary flats were selected for analysis (Fig. 2). These were predominantly mud flats, or sandy, rocky zones where there was fresh water discharge (such as from a spring, stream or storm water drain) into the estuary. Samples were taken at boat moorings close to the open sea (S1, S9, P5), wetlands (S8, P10), older urban developed areas (>30 years ago) (S2, S3, S6, S7), recent urban developed areas (<30 years ago) (P4, P6, P7, P8, P9), industrial sites (S4, S5), farming sites (P1, P3, P10) and an older urban developments with septic tanks (P2).

#### 4.1.2. Sample collection

The study occurred in summer, between 14 January and 3 February, 2004. Sampling was carried out at 18 sites around the estuaries in the intertidal region during low tide ( $\pm 2$  hours of low tide). During sampling, weather conditions were fine, with no rain. Localities of sampling sites were recorded using a handheld Global Positioning System unit (GPS). Algae and benthic organisms were collected into plastic bags, chilled immediately and frozen in the laboratory after sorting and rinsing with distilled water. In addition, surface sediments to a depth of one cm were scraped using a large plastic spade, placed in pre-cleaned plastic sample bottles, and stored in the freezer. A 1 L sample of water to determine POM was also taken at each site. A nearby artificial lake receiving solely terrestrial derived input was also analysed for POM and is used in this study for comparison as a control site and terrestrial end-member. Sediments and POM were collected from all sites. Common cockles were found in all sites sampled apart from sites S7 (a rocky storm water outfall). Mud snails were found in all sites sampled apart from sites S7, S9 and P8. *Ulva* was found at all sites except S2 and S9. *Gracilaria* was found at all sites except S2, S3 and S9.

#### **4.1.3. Sample preparation of sediments**

Surface sediments were separated into two portions. The first, used for stable isotope analysis, was dried at 40°C overnight, weighed and sieved to partition the fine, silty fraction (< 152 µm) containing organic detritus, from the coarse, sandy fraction (> 152 µm) containing sand. Removal of inorganic carbon (CaCO<sub>3</sub>) from the pre-weighed fine fraction was performed by demineralization in 1M hydrochloric acid (HCl) overnight. Each sample was then centrifuged at 3500 rpm with three washes of distilled water to neutralize the acid, dried overnight and re-weighed. The second portion was dried, ground and sent for heavy metal analysis (Environmental Services Limited, Lower Hutt) and total organic carbon analyses (TOC).

#### **4.1.4. Sample preparation of water**

Water collected at each site was filtered onto pre-combusted filter papers (GF/F 2.5 cm diameter), and heated at 450°C for 3 hours. Suspended POM was isolated by rinsing the filter papers with three aliquots of 1M HCl to remove inorganic carbon from the filtrate and dried at 40°C.

#### **4.1.5. Sample preparation of algae**

Macro algae were washed with 1M HCl to remove any calcareous (inorganic carbon) adhesions, and rinsed with distilled water. Samples were then freeze-dried and ground into a fine homogeneous powder using a mortar and pestle with the addition of liquid nitrogen when required to aid grinding in preparation for stable isotope analysis.

#### **4.1.6. Sample preparation of cockles and mud snails**

Common cockles (*Austrovenus stutchburyi*) were sorted by size and separated into two groups: small cockles (juveniles with shell length < 20 mm, less than one year old) [55], and large cockles (adults with shell length > 20 mm, older than 1 year). Juvenile (shell length < 20 mm) and adult (shell length > 20 mm) cockles and mud snails (*Amphibola crenata*) were shucked to remove their shells. The mid-gut gland (stomach and bowels) of the shucked adult cockles and mud snails were separated from the rest of the tissue for separate analysis. This enabled a direct comparison of freshly ingested food sources, which still retain the original isotopic signature (through is often visually unidentifiable) of those food sources, such as algae and POM from the water column. All tissue and gut samples were freeze dried and ground into a homogeneous powder. Delipidization was not performed during the preparation of these animals.

#### **4.1.7. Stable isotope analysis**

Stable isotope analysis was performed on surface sediments, POM, *Ulva*, *Gracilaria* and invertebrates. Ground biological samples and dematerialized sediment samples were analysed for carbon ( $\delta^{13}\text{C}$ ) and nitrogen ( $\delta^{15}\text{N}$ ) stable isotope ratios and C/N ratios. Around 2–10 mg of sediment, and 1–2 mg of algae or invertebrate tissue from each site were pre-weighed into tin capsules and flash combusted at 1000°C using an ANCA (automated nitrogen and carbon analyser) in continuous flow with a PDZ Europa Ltd GEO 20–20 (EA–IRMS) at the Stable Isotope Laboratory, GNS Science, Lower Hutt. Internal working standards (flour, sucrose, beet sugar, Montana Soil and leucine) previously calibrated to international standards, were used to assess reproducibility and precision. Three replicates of each sample were assessed in duplicate to less than 0.2‰ for  $\delta^{13}\text{C}$  and less than 0.3‰ for  $\delta^{15}\text{N}$  (1 $\sigma$ ).

#### 4.1.8. Heavy metal analysis

Heavy metal analysis of a composite cockle sample comprising the soft body tissue from the 10 smallest ‘adult’ cockles (between 20–30 mm size), and associated surface sediments were determined for each site. Pre-treatment of cockles and sediments was performed by taking 2.5 g of wet cockle tissue sample or 0.5 g of dry sediment and 2.5 mL of HNO<sub>3</sub>/0.5 mL HCl (+2 mL water for dry samples), digestion this at 85°C for 1 hour, cooling, and adjusting volumetrically to 50 mL before analysis via ICP-MS (Inductively Coupled Plasma-Mass Spectrometry) at Hills Laboratory, Hamilton.

### 5. RESULTS AND DISCUSSION

#### 5.1. Effects of allochthonous input on food web dynamics

A range of macro algae; *Ulva lactuca*, *Gracilaria secundata*, Eel grass (*Zostera capricornii*), green epilithic algae (found on rocks), two benthic invertebrates (cockles and mud snails), POM and surface sediments, sampled from 18 sites around the two estuaries, were investigated using stable carbon and nitrogen isotopes (Table 1). The isotopic range of the macro algae and invertebrates characterizes and constrains their principal nutrient sources (Fig. 3). Consumers such as cockles (benthic filter feeders) were found to be isotopically more enriched in <sup>15</sup>N and

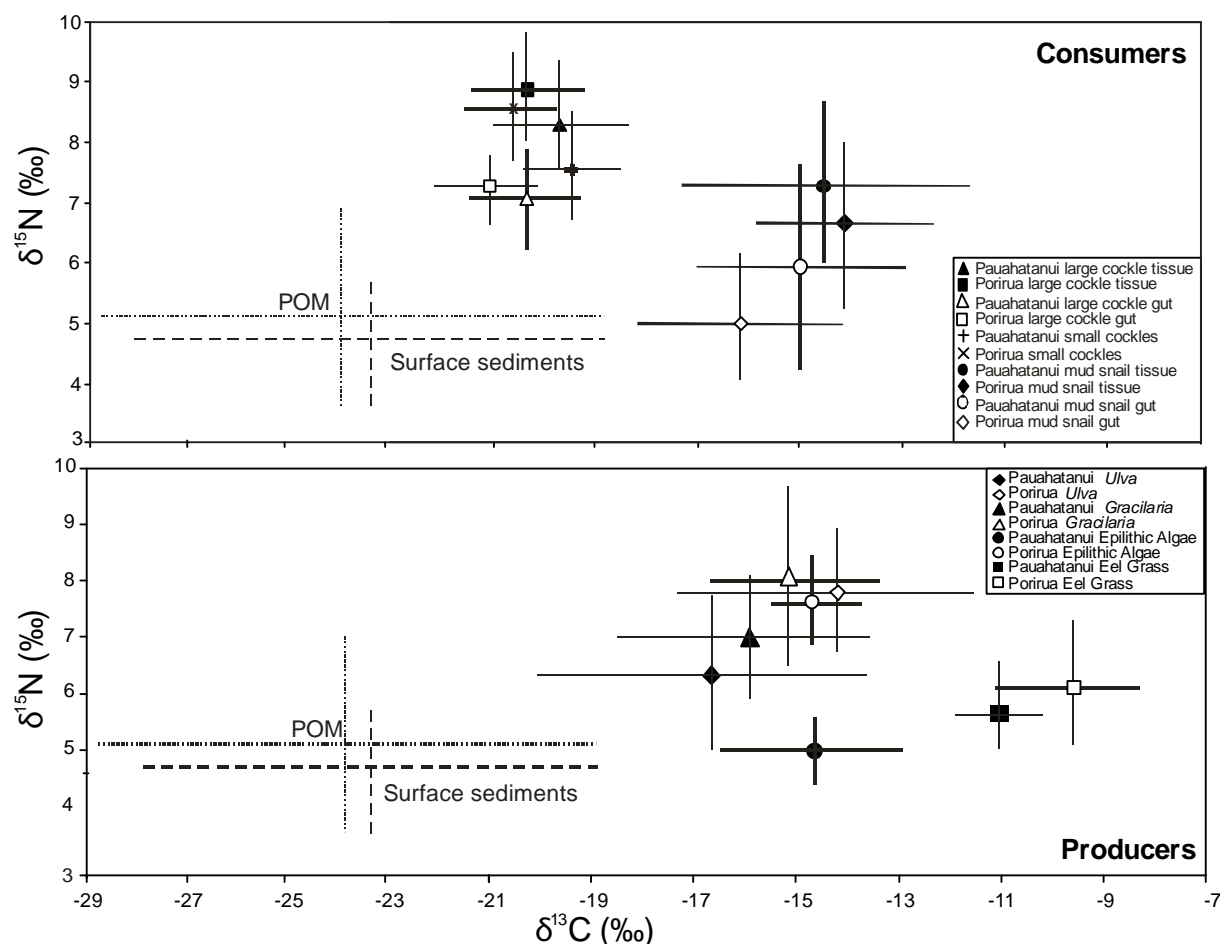

FIG. 3. Food web dynamics of some consumers and producers from Porirua Harbour (P1–P10) and Pauahatanui Inlet (S1–S9).

more depleted in  $^{13}\text{C}$  than mud snails (deposit feeders and grazers). Large cockle tissue and mud snail tissue were enriched in  $^{15}\text{N}$  by around 1.5 to 2‰ relative to their corresponding gut contents. Cockle tissue and mud snail tissue from Pauatahanui were enriched in  $^{13}\text{C}$  by around 1‰ relative to their gut contents, but mud snail tissue from Porirua was enriched in  $^{13}\text{C}$  by up to 2.5‰ relative to gut contents. Porirua mud snails had larger  $\delta^{13}\text{C}$  and  $\delta^{15}\text{N}$  shifts between gut content and body tissue than Pauatahanui mud snails, although Pauatahanui mud snails were the consumer with the largest range of  $^{13}\text{C}$  values over the 18 sites.

The range of  $\delta^{13}\text{C}$  and  $\delta^{15}\text{N}$  values for cockle tissue and gut were relatively constrained for both estuaries, compared to those of mud snails, which had a larger range of isotopic values. These initial results confirm cockles and mud snails consume different food sources. The wider range of  $\delta^{13}\text{C}$  and  $\delta^{15}\text{N}$  values for mud snail tissue and gut than for the cockle tissue and gut indicates the mud snails' diet was more diverse than that of the cockles.

Potential food sources were investigated for the two invertebrates. Grazers and deposit feeders such as mud snails are known to feed on primarily on epilithic and macro algae, detritus, and sediments (containing aquatic OM and SOM) coated with biofilms, while filter feeders such as cockles primarily remove suspended particles (POM) from the water. From the invertebrates sampled in this study, the isotopic signature of their gut contents can be directly compared with the isotopic signature of potential food sources. Figure 3 suggests that eel grass detritus does not appear to contribute significantly to either cockle or mud snail diets due to its enriched  $\delta^{13}\text{C}$  signature compared to cockle and mud snail gut  $\delta^{13}\text{C}$  signatures. Cockle gut most closely matches with POM and surface sediments rather than Algae detritus. The isotopic signature of mud snail gut most closely matches epilithic algae and *Ulva*, with some contribution from *Gracilaria* and surface sediments.

## 5.2. Proxy Indicators

At each site, stable isotope ratios of sediments, POM, macro algae and invertebrates and contaminant levels of sediments and cockles provide an indication of the impact of various land uses in each catchment region around the two estuaries. Land derived OM can be detected in aquatic sediments, POM and invertebrates (with correspondingly more negative  $\delta^{13}\text{C}$  values), while some DIN is incorporated into POM and also used by macro algae. Invertebrates found around the various stream outlets in the estuaries will reflect a mixed isotopic signature in their gut and body tissue comprising the isotopic signature of their autochthonous environment, and the isotopic signature of those nutrients associated with allochthonous inputs. They also ingest persistent inorganic contaminants such as heavy metals and organic contaminants such as polycyclic aromatic hydrocarbons (PAHs) from suspended POM and surface sediments. Furthermore, seasonal events such as storms and flooding amplify the allochthonous contribution to sediments and organisms in aquatic environments.

On the basis of food web dynamics from Sec. 5.1, four proxy indicators are proposed to examine the flow of nutrients and land derived OM into the estuaries:

- (1) **Carbon from sediments as longer term accumulators (>1 a) of organic carbon from soil erosion**, as there is a sedimentation rate of 2–3 mm per year around the two estuaries [53]. Carbon isotopes of aquatic surface sediments are used as a proxy for land use change, specifically soil erosion, as organic material retained in the aquatic surface sediments primarily reflects the background aquatic signal, combined with the transport

and accumulation of material such as soils and terrestrial debris, and a small component of organic contaminants (hydrocarbons, pesticides etc) which are usually resistant to biodegradation.

- (2) **Carbon from POM as a shorter term indicator (< 1 week) with a mixture of organic carbon from in situ aquatic detritus and allochthonous contributions from soil erosion and urbanization.** Autochthonous POM comprises predominantly phytoplankton, (including diatoms and micro algae etc), while allochthonous POM is derived from transportation of fine suspended particles of terrestrially derived material into stream, rivers and estuaries by surface water runoff where it is further dispersed by currents. This transport mostly occurs during precipitation events or during periods of catchment erosion and subsequent transport via connecting waterways.
- (3) **Nitrogen from macro algae such as *Ulva* and *Gracilaria* as short term accumulators (<1 month) of nitrogen from waste water and water column dissolved inorganic nitrogen (DIN).** Macro algae are an excellent proxy of nitrogen input (N isotopes), assimilating nitrogen from the water column quickly at each site and reflecting recent environmental changes in their isotopic signature [56].
- (4) **Carbon and nitrogen from juvenile cockle tissue (shellfish with an outer shell which is less than 20 mm of the shell length) as short term accumulators (< 6 months) of carbon and nitrogen from the POM** due to their filter feeding characteristics from the water column. Juvenile cockles have a faster metabolism than adult cockles [57], and the isotopic signatures of their tissue is more responsive to POM change. Juvenile cockles are used as a proxy for water quality, as they reflect short term POM changes in the estuaries, while older cockles retain a broader long term signal of their environment.

### 5.3. Sediments and POM as indicators of land use change

Stable carbon isotope analysis of the POM and the demineralized fine fraction of surface sediments from each site were analysed to determine the short and longer term origins of the organic contribution. The  $\delta^{13}\text{C}$  values of sediments ranged from  $-18.9$  to  $-28.5\text{‰}$ , while the POM ranged from  $-18.6$  to  $-27.8\text{‰}$ . Sediments and POM collected from sites closest to the open sea in the Porirua Harbour (S1, S2, S8, S9) had the most

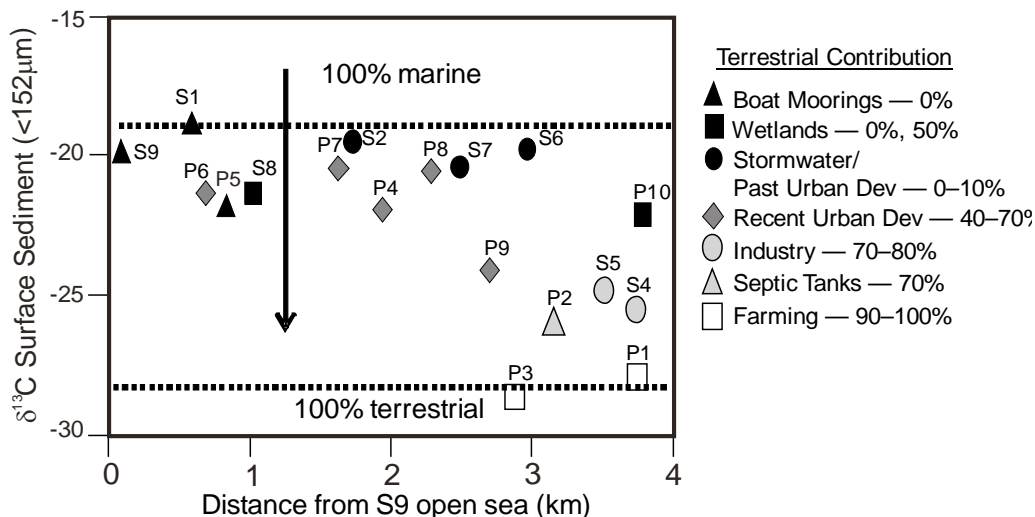

FIG. 4. Stable carbon isotopes of fine fractions ( $<152\ \mu\text{m}$ ) of surface sediments from Pauatahanui Inlet (S1–S9) and Porirua Harbour (P1–P10), and allochthonous mixing (%).

TABLE 3. SUGGESTED LAND USE OF SAMPLING SITES FROM PAUATAHANUI INLET AND PORIRUA HARBOUR CATCHMENT BASED ON GIS OBSERVATIONS [53]

Estuary	Sampling site	Principal landuse in catchment	%TOC (sediments) (g/100g)*	%TPAH (sediments) (µg/kg)*
Pauatahanui Inlet	P1	Farming	0.6	0
	P2	Septic Tanks	1.5	55
	P3	Farming	2.8	0
	P4	Recent Urban Development	2.8	1493
	P5	Boat Moorings	0.6	92
	P6	Recent Urban Development	0.5	77
	P7	Recent Urban Development	0.3	880
	P8	Recent Urban Development	0.1	209
	P9	Recent Urban Development	0.2	89
	P10	Wetlands/Farming	0.1	135
Porirua Harbour	S1	Boat Moorings	0.2	6
	S2	Past Urban Development	1.0	5
	S3	Lagoon with Past Urban Development	Not measured	
	S4	Industry	0.4	799
	S5	Industry	1.5	106
	S6	Past Urban Development	0.7	245
	S7	Past Urban Development	0.8	625
	S8	Wetlands	0.4	640
	S9	Boat Moorings	0.1	0

\* Dry weight

positive  $\delta^{13}\text{C}$  values, indicating a strong marine contribution, while samples farthest away from the open sea in the Pauahatanui Inlet had the most negative values (P1, P2, P3) (Table 2) indicating a significant terrestrial contribution.

Surface sediments sampled from Porirua Harbour, closest to the open sea were located at boat marinas (S1 and S9). These sites had positive  $\delta^{13}\text{C}$  sediment values of  $-18.9$  and  $-20.2\text{‰}$  respectively, suggesting primarily an autochthonous marine contribution (Fig. 4). Sites from the Porirua Harbour which receive surface water from older urban developed areas (S2, S6, S7), also had more positive  $\delta^{13}\text{C}$  surface sediment values of around  $-20\text{‰}$ , even though these sites are further away from the open sea (Fig. 4). This suggests the amount of soil erosion from these established urban catchment zones is minimal, as more positive  $\delta^{13}\text{C}$  values are characteristic of a low terrestrial ( $\text{C}_3$ ) contribution and a stronger marine influence. This is also seen in the Pauahatanui Inlet, where sites receiving catchment drainage from older developed urban areas (P6, P7, P8) have more positive sediment  $\delta^{13}\text{C}$  values of around  $-20$  to  $-22\text{‰}$  than more recently developed urban areas (P9, P4), regardless of their distance from the open sea (Fig. 4).



These values are consistent with a higher allochthonous terrestrial ( $C_3$ ) contribution from soil erosion, due to lower topsoil stability in these catchments.

Wetland sites (P8, P10 and S8) have more positive sediment  $\delta^{13}C$  values than urban developed areas, farming and industry, consistent with the riparian action of the plants, which retain sediments and organic detritus. Planting effective sediment traps such as grasses and trees act as riparian zones and reduce soil erosion. Planting also lowers a catchment's susceptibility to erosion during storm events, therefore organic matter retained in these older urban developed sites is predominantly autochthonous and estuarine derived.

The C:N ratios of sediments vary from 8.3 to 13.4, and POM varies from 8.9 to 14.6. A plot of the C:N ratio against  $\delta^{13}C$  values shows the relationship between specific source contributions. Using data from Kendall et al. (2001) [10] and references therein (Table 1), sediments can be characterized by comparison with major classes of organic contributors. The range of sediment and POM carbon isotope values and C:N ratios from Pauatahanui Inlet and Porirua Harbour are overlaid in Fig. 1. In most sites closest to the open sea (P4, P5, P6, P8, S2, S3, S7, S8, S9), there are higher C/N ratios in POM than in sediments, suggesting a higher ratio of terrestrial (soil derived) contribution to the POM. Sediments would contain a higher ratio of aquatic detritus due to the large amount of benthic organisms and accumulated aquatic detritus which has settled out of the water column, while fine terrestrial derived particulate material would be preferentially suspended in the water column depending on transport from source to sink. The preservation of POM in sediments is also reduced in sediments due to benthic consumption of POM, oxidation, and bacterial processes [10].

#### 5.4. Mixing models

The extent of allochthonous input in a near shore marine environment was previously determined with some success by the use of a simple two source mixing model [56] whereby two known end members were used to determine a mixture containing X% of source 1 and (1-X%) of source 2. More detailed mixing models are available which incorporate three sources and dual isotopic analysis [8, 58–60]. Aquatic end member  $\delta^{13}C$  values can be assumed from sites closest to the open sea or those with the most positive  $\delta^{13}C$  values (S1 and S9, -19‰), while terrestrial end member  $\delta^{13}C$  values can be assessed from those sites most distant from the open sea or those with the most negative  $\delta^{13}C$  values (P1 and P3, -28‰).

We can assume a two member mixing model based on allochthonous vs. autochthonous derived organic matter, defined by:

$$C = (C_{all} + qC_{aut}) / (1 + q) \text{ and}$$

$$\delta^{13}C = (C_{all}\delta^{13}C_{all} + qC_{aut}\delta^{13}C_{aut}) / (C_{all} + qC_{aut}),$$

Where  $C_{all}$ ,  $C_{aut}$ ,  $\delta^{13}C_{all}$ ,  $\delta^{13}C_{aut}$  represent the concentrations and carbon isotope compositions of the mixing components (allochthonous and autochthonous carbon), and  $q$  the mixing ratio  $m_{all}/m_{aut}$  of the two masses.

Then we can determine that based on  $\delta^{13}C$  values, almost all the carbon retained in fine surface sediment ( $< 152 \mu m$ ) from farming land use sites P1 and P3 is terrestrially derived ( $\delta^{13}C = -28$  to  $-27\%$ ). Applied to other sites, recent urban development (P4, P9) tends to contribute around 30 to 50% of terrestrially derived carbon, while boat moorings (S1, S9) and older urban de-

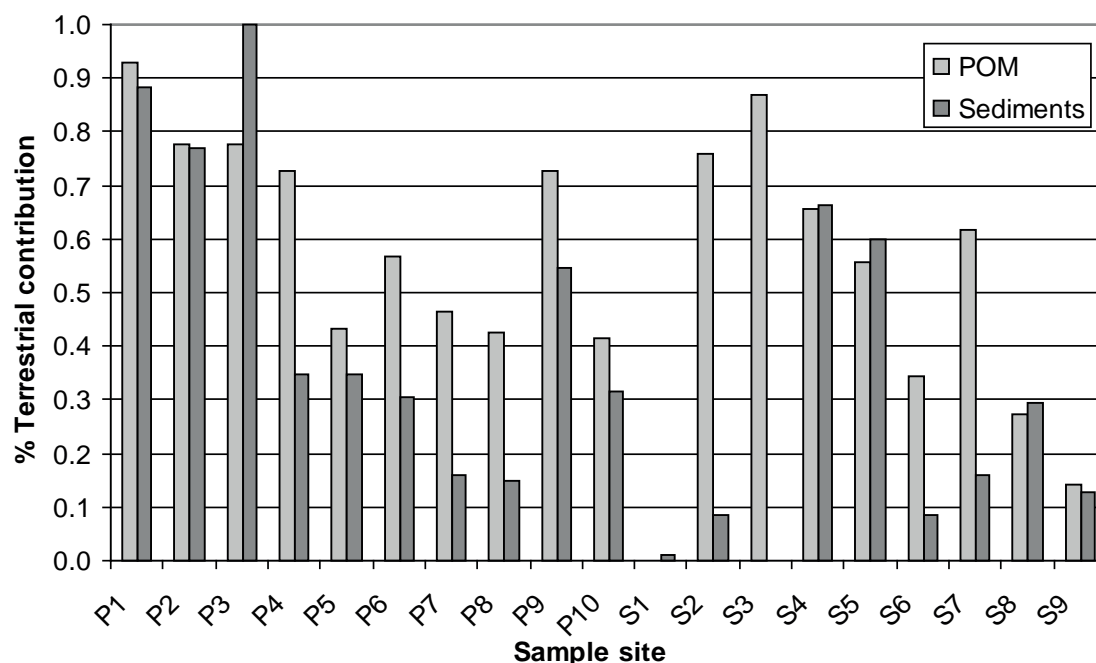

FIG. 5. The % of terrestrial contribution to sediments and POM from sampling sites around Porirua Harbour (P1–P10) and Pauatahanui Inlet (S1–S9).

velopment (P7, S2, S6, S7) have lower levels (10 to 30%) of terrestrial derived carbon in fine surface sediments.

A comparison of terrestrial contribution to POM and sediments, estimated using a two point mixing model, shows that in most sites sampled, the POM contains a higher ratio of allochthonous:autochthonous input than in sediments (Fig. 5, Table 2). Only the farming sites (P1, P2, and P3), industrial sites (S4, S5) and sites S8 (wetlands) and S9 (boat mooring) have similar or higher allochthonous contributions retained in the sediments than are present in the POM, suggesting a high contribution of heavier particulate organic material which settles rapidly and is preserved in situ, most likely from transported soil erosion within the catchment. Suspended POM can be considered to be a short term, non-localized indicator of organic material, as tidal change and currents move POM quickly from one site to another, while sediments are retained in situ at each site and are only disturbed during higher energy events such as storms or flooding.

High (>0.5%) terrestrial contribution to sediments at some sites (P1, P2, P3, P9, S4, S5) is primarily due to farming, industry or recent urbanization. Sites with a high (>0.5%) terrestrial contribution to the POM (P1, P2, P3, P9, S4, S5) are located near stream and storm water drains with higher outflows which have increased particulate transportation abilities.

### 5.5. Macro algae as indicators of nutrient input

Ulva collected from the two estuaries (Fig. 6) show isotopic variations which characterize nutrient inputs on the basis of  $\delta^{15}\text{N}$  values. The Porirua Harbour has more positive nitrogen isotopes between +7 to +9‰, compared to the Pauatahanui Inlet which lie between +5 to +7‰, (with an exception of P2 at +7.8‰). Sites with the most positive  $\delta^{15}\text{N}$  values of Ulva are

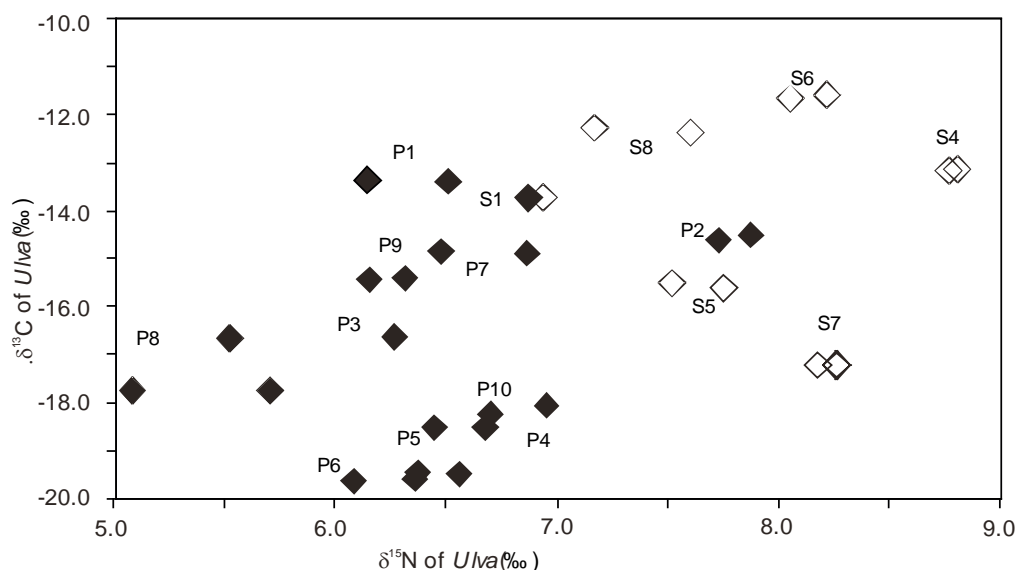

FIG. 6. Stable carbon ( $\delta^{13}\text{C}$ ) and nitrogen ( $\delta^{15}\text{N}$ ) isotope composition of *Ulva* from the Pauatahanui Inlet (solid diamonds) and Porirua Harbour (outline diamonds).

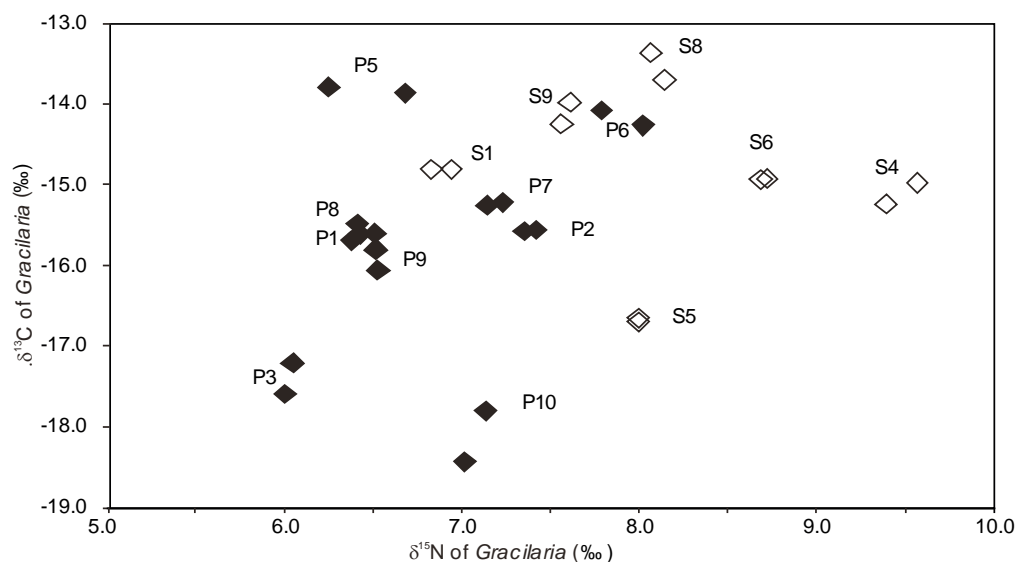

FIG. 7. Stable carbon and nitrogen isotope composition of *Gracilaria* from the Pauatahanui Inlet (solid diamonds) and Porirua Harbour (outline diamonds).

located around the industrial area (S4), and storm water drains (S6 and S7) servicing long established urban habitats. These values are consistent with human or animal waste derived nitrogen, and/or denitrification (loss of  $^{14}\text{N}$ ) from in situ nitrogen. Sites with lower  $\delta^{15}\text{N}$  values of *Ulva* are consistent with streams and drainage from recent subdivisions and urbanization, suggesting terrestrial/soil derived nitrogen.

Stable nitrogen isotopes of *Gracilaria* were also determined (Fig. 7) to provide a comparison of nitrogen pathways with those from *Ulva*. In general, *Gracilaria* from the Porirua Harbour sites had higher  $\delta^{15}\text{N}$  values than that from the Pauatahanui Estuary sites. However, it was not possible to find *Gracilaria* growing in four sites (P4, P5, S2, and S7) during the period of

the study, either due to lack of colonization or lack of suitable growing conditions. *Gracilaria* with lower  $\delta^{15}\text{N}$  values were derived from sites where the surrounding land use was primarily recent urbanization and farming areas. Nitrogen from these inputs contains more soil N contribution, while *Gracilaria* with more positive  $\delta^{15}\text{N}$  values were sampled from sites whose catchments are directly impacted by industrial areas and older urban catchments.

Both *Ulva* and *Gracilaria* display a wide range of  $\delta^{13}\text{C}$  values from between  $-12$  to  $-20\text{‰}$ . While suspended POM will not affect the isotopic composition of algae directly, the pH of stream discharges, water temperature and DIC content, as well as the amount of time these intertidal algae spend exposed to atmospheric  $\text{CO}_2$  will affect their final carbon isotopic composition. It appears that those samples most distant from the open ocean and most likely to have the highest freshwater influence (sites P3, P10, S5), exhibit more negative  $\delta^{13}\text{C}$  values, while those that are closest to the open marine environment have less negative  $\delta^{13}\text{C}$  values (P5, P6, S1, S8, S9).

### 5.6. Cockles as sensitive indicators of water quality (POM input)

One of the most abundant and important invertebrates in the two estuaries is the common cockle (*Austrovenus stutchburyi*). Cockles are surface dwellers and filter feeders, removing suspended organic detritus (POM), microphytobenthos and improving water quality as they siphon water through their gills to get the food and oxygen they require [61]. In 1976, it was calculated that a third of the volume of incoming tides passed through the gills of cockles daily [62]. Cockles, at that time, made up 80% of all biomass of mud flat organisms, and were one of the major food sources of fish and shore birds.

Isotopic analysis were performed on both adult (large  $>20$  mm shell length, age  $>1$  year) and juvenile (small  $<20$  mm shell length, age  $<1$  year) cockles from each sampling site. The  $\delta^{13}\text{C}$  values of adult cockle tissue ranged from  $-18.4$  to  $-21.2\text{‰}$  ( $\Delta = 2.8\text{‰}$  range) and juvenile cockle tissue ranged from  $-18.5$  to  $-21.3\text{‰}$  ( $\Delta = 2.8\text{‰}$  range). The  $\delta^{13}\text{C}$  values of adult cockle gut ranged from  $-19.2$  to  $-22.2\text{‰}$  ( $\Delta = 3.0\text{‰}$  range), while it was not feasible to separate the cockle gut from juvenile cockles. The  $\delta^{15}\text{N}$  values of adult cockle tissue ranged from  $7.5$  to  $9.7\text{‰}$  ( $\Delta = 2.2\text{‰}$  range) and small cockle tissue ranged from  $6.7$  to  $9.2\text{‰}$  ( $\Delta = 2.5\text{‰}$  range). The  $\delta^{15}\text{N}$  values of adult cockle gut ranged from  $6.3$  to  $7.8\text{‰}$  ( $\Delta = 1.5\text{‰}$ ).

Isotopic analysis of cockle tissue reflects their dietary source. Juvenile (small) cockles sampled from the two estuaries are shown to have distinct isotopic signatures (Fig. 8). Porirua Harbour cockles tend to have more negative  $\delta^{13}\text{C}$  values and more positive  $\delta^{15}\text{N}$  values, suggesting different food ( $^{13}\text{C}$  and  $^{15}\text{N}$ ) sources than for the Pauatahanui Inlet cockles.

The more negative  $\delta^{13}\text{C}$  values of Porirua Harbour cockles suggest that the suspended POM has a more terrestrial contribution than the Pauatahanui cockles and that the Pauatahanui cockles have eaten more macro algae fragments such as *Ulva* and *Gracilaria*.

The more positive  $\delta^{15}\text{N}$  values seen in Porirua Harbour tend towards anthropogenic N contributions, consistent with nitrogen derived from human derived anthropogenic input. The Pauatahanui Estuary tends towards less positive  $\delta^{15}\text{N}$  values which are more consistent with natural estuary conditions or soil derived nitrogen compounds. Only sites P2 and P10 from the Pauatahanui Estuary are more enriched relative to the other sites. This is possibly due to a septic tank waste contribution from site P2, and a mix of wetland and farming at site P10 potentially con-

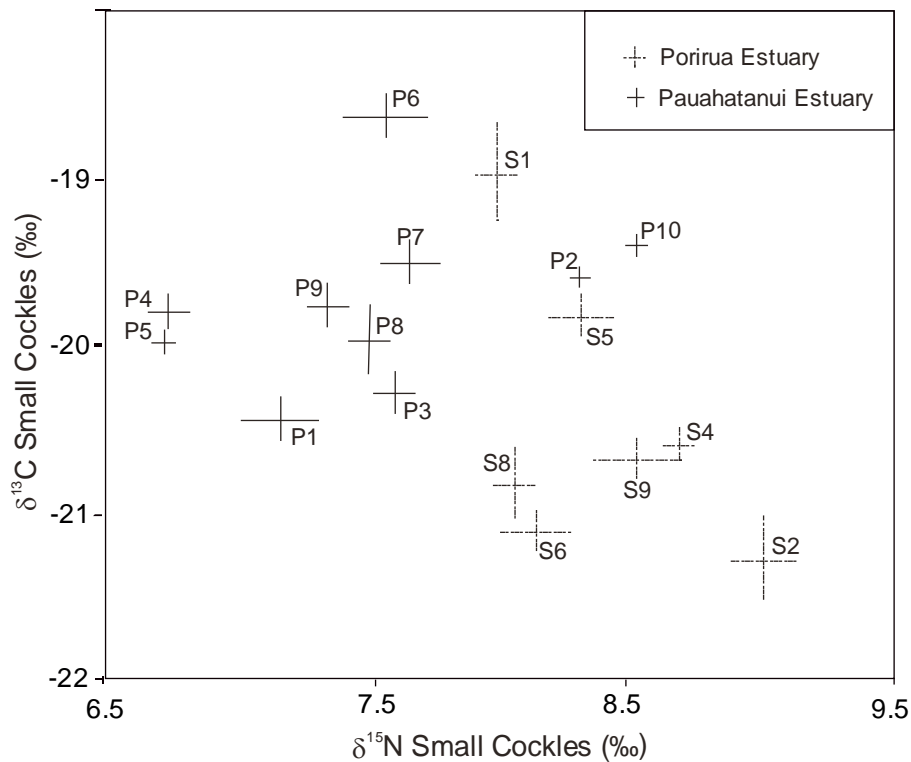

FIG. 8. Stable carbon and nitrogen isotope values of small cockles.

tributing stored and leached nitrous compounds which are affected by bacteria degradation and denitrification. However with strong tidal action, as is the case in these estuaries, suspended POM is likely to be transported around each estuary and not localized or specific in any area.

### 5.7. Heavy metals

In the Porirua Harbour, Wellington, sediment and cockles were analysed for heavy metals (Fig. 9). Sediments and cockles sampled from sites near the industrial area (S4) contained higher amounts of chromium, copper, lead, nickel and zinc than other sediments and cockles in the study. These levels resulted from long term accumulations of industrial contaminants from past battery manufacturing processes.

At the boat mooring sites (S1, S9) slightly higher levels of cadmium and chromium are bio-accumulating in cockles relative to other sites, most likely associated with heavy metals used in anti fouling paints on boat hulls. Neighboring Pauatahanui Inlet is considered to be less contaminated by industrial processes and urbanization; however some sites do contain measurable and noticeable heavy metals in surface sediments. At sites P7 and S7 (associated with older urban areas) higher lead, copper and zinc contents accumulated in sediments can be assigned to the traditional use of lead, copper and zinc in plumbing and guttering of houses.

## A. Common Cockle

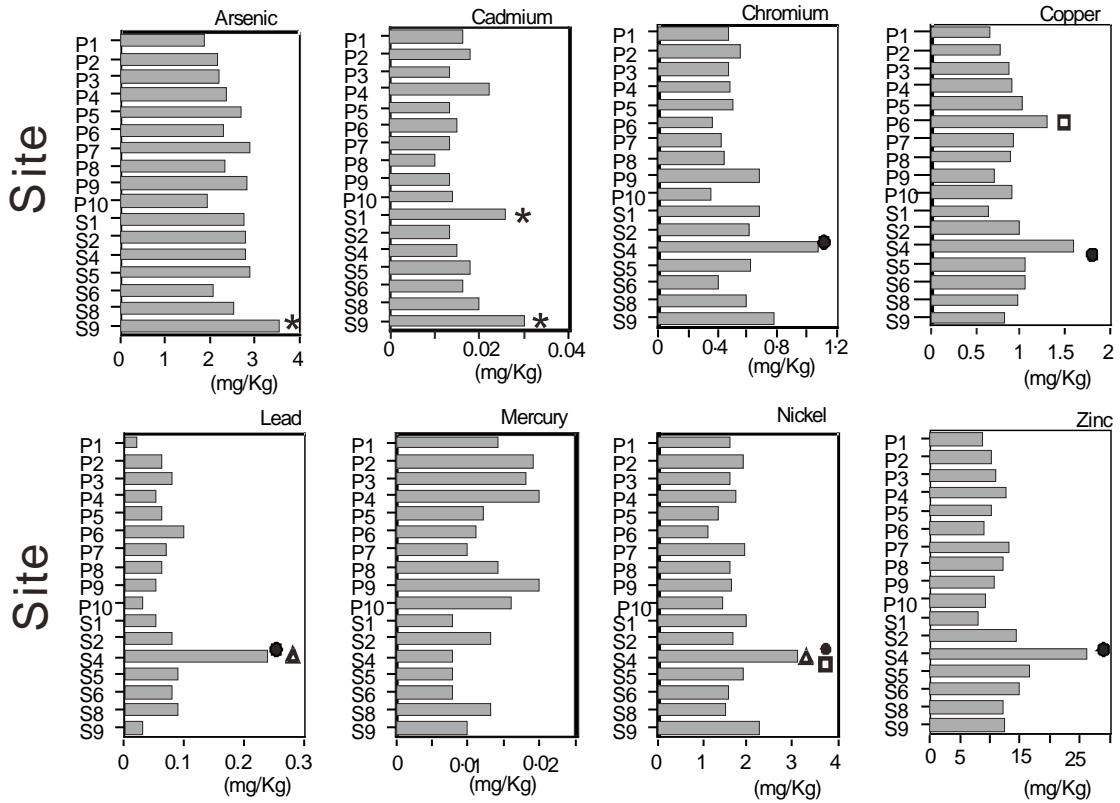

## B. Sediments

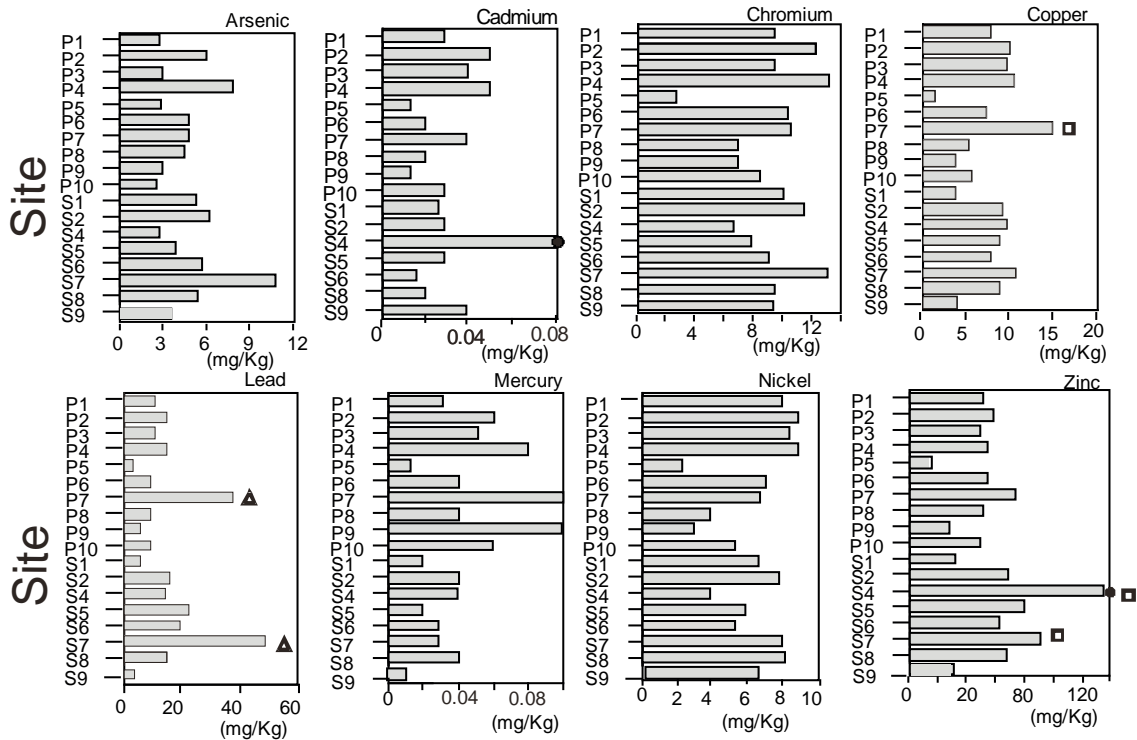

Key: ● Industry    □ Urbanisation    ▲ Rooding    \* Boat Mooring

FIG. 9. Heavy metal concentrations (mg/kg) of (a) common cockle *Austrovenus stutchburyi* (top), (b) surface sediments (bottom) in Pauatahanui Inlet and Porirua Harbour.



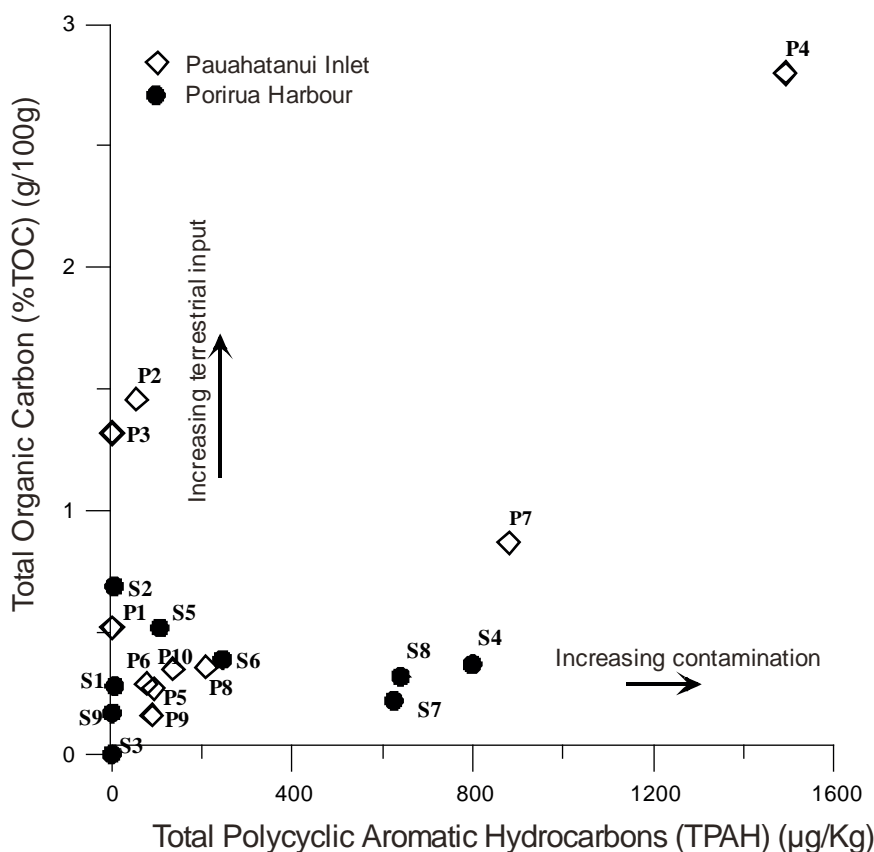

FIG. 10. PAH levels in surface sediments sampled from Pauatahanui Inlet (outline diamonds) and Porirua Harbour (solid circles).

### 5.8. Other contaminants

The effects of various organo-pollutants were studied in both estuaries. Where the concentration of organic pollutants is highest, they may influence the carbon isotopic composition of organic matter in sediments, and are potentially toxic to estuarine ecology. Detectable levels of total polycyclic aromatic hydrocarbons (TPAHs) were found in sediments from most sites in the two estuaries (Table 3, Fig. 10). In particular, sediments from site P4 had the highest PAH level (1500 mg/kg), and a significantly higher %TOC level compared to other sites. It is likely that these contaminants are contributing to the more negative carbon isotopic value ( $-25\%$ ) found in these sediments. As this site is also used for launching small motor boats, it is possible that fuel spills have accumulated over time in the sediments, and these PAHs form part of the biodegraded residues retained in the sediment.

Sediments from site P7 had a PAH level of 880  $\mu\text{g}/\text{kg}$ , and were sampled at the mouth of a stream receiving runoff from a large catchment area, mostly associated with urban roads (also seen in heavy metal analysis with higher lead levels from leaded petrol residues), hence vehicle emissions are likely to be a contributing factor. A similar scenario can account for higher PAH levels in sites S7 and S8, draining older urban areas (625 and 640  $\mu\text{g}/\text{kg}$ ). Site S4 (800  $\mu\text{g}/\text{kg}$ ) is the outlet of a stream which winds through the industrial area of the main Porirua catchment, so it is indeed likely that past spillages have accumulated in surface sediments around this region.

## 6. CONCLUSIONS

Stable isotopes have been shown to be a useful tool for identifying the effects of different land use activities on two estuaries fed by tides, discharging streams, wetlands and urban storm water drains. These activities are primarily derived from urbanization, farming, and industrial processes. In particular, fine grained sediments, cockle tissue and algae are shown to be useful proxy indicators of allochthonous input. Sediments with contributions from rural land use tend to have more negative  $\delta^{13}\text{C}$  and  $\delta^{15}\text{N}$  values than those from urban land use. This is due to a larger plant contribution derived from erosion processes of pastoral and farming land and synthetic fertilizer usage. Sediments with contributions from urban processes tend to have more positive  $\delta^{15}\text{N}$  values associated with denitrification of anthropogenic nitrogen. Comparisons between sediments derived from recent and older urban developments show that recent urbanization has more negative  $\delta^{13}\text{C}$  values than older urban areas. This is indicative of a higher ratio of soil derived organic matter to the overall organic pool than with past urban development, as in recent urban areas the topsoil is often more exposed and mobile, so is prone to transportation via wind and rain erosion. Wetland areas have more positive  $\delta^{13}\text{C}$  values than farming areas, as riparian barriers retain allochthonous (terrestrially derived) material from the surrounding watershed. However there is an increase in nitrogen input and  $\delta^{15}\text{N}$  isotopic values in such areas, potentially due to the decomposition, fractionation and leaching of soluble nitrous compounds.

Isotopic analysis of potential *in situ* nutrients (algae and suspended POM) of filter feeders such as cockles, show that they principally remove suspended POM from the water column, whilst deposit feeders and grazers such as mud snails use a variety of epilithic and macroalgae algae as their primary food source. Cockles and algae can be useful proxies of terrestrial input (POM) and anthropogenic nitrogen found in aquatic systems, to the extent that the two estuaries can be identified on the basis of carbon and nitrogen stable isotopes. In general, the Porirua Harbour cockles have more negative carbon isotopes, suggesting their diet consists of more terrestrial derived POM in the water, or that the shallower Pauatahanui Inlet has more positive DIC affecting the isotopic composition of phytoplankton and total POM. Separation of the two estuaries on the basis of nitrogen isotopes is also possible, suggesting that nitrogen stable isotope ratios of algae and small cockle individuals can be used as an indicator of pollution effect and nutrient input.

Combined with further complementary techniques such as the analyses of heavy metals and organo-pollutants which offer anthropogenic detection of contaminants undetected by stable carbon and nitrogen isotopes, it is possible to build a snapshot of the current health of these waterways. Historical catchment information can further be derived from the assessment of past land use maps, with chemical (including isotopic) evaluation of sediment cores, whilst future predictions can be made based on current environmental signals within the estuary and anticipated land-use trends.

## 7. ACKNOWLEDGEMENTS

The author would like to thank K. Kurata, Shimane University, Japan and G. Stephenson (Wellington Regional Council) for their participation in the study, M. Page and N. Trustrum (GNS Science) for comments and assistance regarding land use within the Pauatahanui Inlet and Porirua Harbour, G. Stephenson and Wellington Regional Council for funding heavy metal analysis (cockle heavy metal analyses were performed by Environmental Laboratory

Services Limited, Lower Hutt, sediment sample preparation by National Institute of Water & Atmospheric Research Limited, Hamilton and sediment metals and PAH analyses were performed by R J Hill Laboratories Limited, Hamilton, under subcontract to NIWA), and to T. Baisden (GNS Science) and B. Fry (Louisiana State University) for helpful comments on this manuscript.

## REFERENCES

- [1] HEDGES, J.I., et al., Compositions and fluxes of particulate organic material in the Amazon River, *Limnol. Oceanogr.* **31** (1986) 717–738.
- [2] BOON, P.I., BUNN, S.E., Variations in the stable isotope composition of aquatic plants and their implications for food web analysis, *Aquat. Bot.* **48** (1994) 99–108.
- [3] PETERS, K.E. SWEENEY, R.E., KAPLAN, I.R., Correlation of carbon and nitrogen isotope ratios in sedimentary organic matter, *Limnol. Oceanogr.* **23** (1978) 598–604.
- [4] SWEENEY, R.E., KAPLAN, I.R., Natural abundances of  $^{15}\text{N}$  as a source indicator for nearshore marine sedimentary and dissolved nitrogen, *Mar. Chem.* **9** (1980) 81–94.
- [5] ROUNICK, J.S., WINTERBOURN, M.J., LYON, G.L., Differential utilization of allochthonous and autochthonous inputs by aquatic invertebrates in some New Zealand streams: a stable carbon isotope study, *Oikos* **39** (1982) 191–198.
- [6] WADA, E., MINAGURA, M., MIZUTANI, H., TSUJI, T., IMAIZUMI, R., KARASAWA, K., Biogeochemical studies on the transport of organic matter along the Ot-suchi River watershed, Japan, *Estuar. Coast. Shelf Sci.* **25** (1987) 321–336.
- [7] THORNTON, S.F., MCMANUS, J., Application of organic carbon and nitrogen stable isotope and C/N ratios as source indicators of organic matter provenance in estuarine systems: Evidence from the Tay Estuary, Scotland, *Estuar. Coast. Shelf Sci.* **38** (1994) 219–233.
- [8] SMIT, A.J., “Source identification in marine ecosystems”, *Stable Isotope Techniques in the Study of Biological Processes and Functioning of Ecosystems* (UNKOVICH, M., PATE, J., MCNEILL, A., GIBBS, D.J, Eds), Kluwer Academic Publishers, Dordrecht, The Netherlands (2001) 219–245.
- [9] MEYBECK, M., Carbon, nitrogen and phosphorus transport by world rivers, *Am. J. Sci.* **282** (1982) 401–450.
- [10] KENDALL, C., SILVA, S.R., KELLY, V.J., Carbon and nitrogen isotopic compositions of particulates organic matter in four large river systems across the United States, *Hydro. Process.* **15** (2001) 1301–1346.
- [11] LIU, J.H., KUEH, C.S.W., Biomonitoring of heavy metals and trace organics using the intertidal mussel *Perna viridis* in Hong Kong coastal waters, *Mar. Pollut. Bull.* **51** (2005) 857–875.
- [12] PHILLIPS, D.J.H., RAINBOW, P.S., Barnacles and mussels as biomonitors of trace elements: a comparative study, *Mar. Ecol. Progr. Ser.* **49** (1988) 83–93.

- [13] BOTHERWAY, K.J., GARDNER, J.P.A., Effect of storm drainage on the soft shore ecology of Porirua Inlet, New Zealand, *New Zealand J. Mar. Freshw. Res.* **36** (2002) 241–255.
- [14] WIRTH, E.F., FULTON, M.H., CHANDLER, G.T., KEY, P.B., SCOTT, G.I., Toxicity of sediment associated PAHs to the Estuarine Crustaceans, *Palaemonetes pugio* and *Amphiascus tenuiremis*, *Bull. Environ. Contamin. Toxicol.* **61** (1998) 637–644.
- [15] JACOB, J., “Method development for the determination of polycyclic aromatic hydrocarbons (PAHs) in environmental matrices”, *Quality Assurance for Environmental Analysis – Method Evaluation within the Measurements and Testing Programme (BCR)*, (QUEVAUVILLER, P., MAIER, E., GRIEPINK, G., Eds), Elsevier Science BV (1995).
- [16] MEADOR, J.P., STEIN, J.E., REICHERT, W.L., VARANASI, U., Bioaccumulation of polycyclic aromatic hydrocarbons by marine organisms, *Rev. Environ. Contamina. Toxicol.* **143** (1995) 79–165.
- [17] WINTERBOURN, M.J., ROUNICK, J.S., HILDREW, A.G., Patterns of carbon resource utilization by benthic invertebrates in two British river systems: a stable carbon isotope study, *Arch. Hydrobiol.* **107** (1986) 349–361.
- [18] ROSENFELD, J.S., ROFF, J.C., Examination of the carbon base in southern Ontario streams using stable isotopes, *J. N. Am. Benthologic. Soc.* **11** (1992) 1–10.
- [19] ROSTAD, C.E., LEENHEER, J.A., Organic carbon and nitrogen content associated with colloids and suspended particulates from the Mississippi River and some of its tributaries, *Environ. Sci. Technol.* **31** (1997) 3218–3225.
- [20] WIDORY, D., “The benefit of using isotopes in NO<sub>3</sub> water quality management”, *Application of Isotope Techniques for Assessing Nutrient Dynamics in River Basins*, IAEA, Vienna (in preparation)
- [21] MEYER, B., SEBILO, M., WASSENAAR, L.I., Isotopic assessment of nitrogen cycling in river basins: potential and limitations for nutrient management purposes, *ibid.*
- [22] HADWEN, W.L., BUNN, S.E., Investigating pathways of nutrient and energy flows through aquatic food webs using stable isotopes of carbon and nitrogen, *ibid.*
- [23] MEYERS, P.A., Preservation of elemental and isotopic source identification of sedimentary organic matter, *Chem. Geol.* **114** (1994) 289–302.
- [24] ANGRADI, T.R., Stable carbon and nitrogen isotope analysis of seston in a regulated rocky mountain river, USA, *Regulated Rivers: Research and Management* **8** (1993) 251–270.
- [25] CARACO, N.F., et al., Microbial assimilation of DIN in a nitrogen rich estuary: implications for food quality and isotope studies, *Mar. Ecol. Progr. Ser.* **167** (1998) 59–71.
- [26] THORP, J.H., DELONG, M.D., GREENWOOD, K.S., CASPER, A.F., Isotopic analysis of three food web theories in constricted and floodplain regions of a large river, *Oecologia* **117** (1998) 551–563.
- [27] MCCLELLAND, J.W., VALIELA, I., Linking nitrogen in estuarine producers to land-derived sources, *Limnol. Oceanogr.* **42** (1998) 930–937.

- [28] COLE, M.L., et al., Assessment of  $\delta^{15}\text{N}$  isotopic method to indicate anthropogenic eutrophication in aquatic ecosystems, *J. Environ. Quality* **33** (2004) 124–132.
- [29] SCHAAL, G., RIERA, P., LEROUX, C., Trophic coupling between two adjacent benthic food webs within a man-made intertidal area: A stable isotopes evidence, *Estuar. Coast. Shelf Sci.* **77** (2008) 523–534.
- [30] HILLAIRE-MARCEL, G., “Isotopes and food”, *Handbook of Environmental Isotope Geochemistry*, Vol. 2, (FRITZ, P., FONTES, J.C.H., Eds), Elsevier Science (1986) 507–548.
- [31] FRY, B., SHERR, E.B.,  $\delta^{13}\text{C}$  measurements as indicators of carbon flow in marine and freshwater ecosystems, *Contrib. Mar. Sci.* **27** (1984) 13–47.
- [32] DEGENS, E.T., “Biogeochemistry of stable carbon isotopes”, *Organic Geochemistry* (EGLINGTON, E., MURPHY, M.T.J., Eds), Springer Verlag: New York (1969) 304–329.
- [33] VANDER ZANDEN, M.J., RASMUSSEN, J.B., Primary consumer  $\delta^{13}\text{C}$  and  $\delta^{15}\text{N}$  and the trophic position of aquatic consumers, *Ecology* **80** (1999) 1395–1404.
- [34] BACASTOW, R.B., KEELING, C.D., WHORF, T.P., Seasonal Amplitude Increase in Atmospheric  $\text{CO}_2$  Concentration at Mauna Loa, Hawaii, 1959–1982, *J. Geophys. Res.* **90** (1985) 10529–10540.
- [35] KEELING, C.D., CARTER, A.F., MOOK, W.G., Seasonal, latitudinal, and secular variations in the abundance and isotopic ratios of atmospheric  $\text{CO}_2$ , Results from oceanographic cruises in the Tropical Pacific Ocean, *J. Geophys. Res.* **89** (1984) 4615–4628.
- [36] WIDORY, D., JAVOY, M., Carbon isotopes composition of atmospheric  $\text{CO}_2$  in Paris, *Earth Planet. Sci. Lett.* **215** (2003) 289–298.
- [37] SMITH, B.N., EPSTEIN, S., Two categories of  $^{13}\text{C}/^{12}\text{C}$  for higher plants, *Plant physiology* **47** (1971) 380–384.
- [38] DE NIRO, M., Stable isotopy and archaeology, *Am. Sci.* **75** (1987) 182–191.
- [39] VAN DER MERWE, N., Carbon isotopes, photosynthesis and archaeology, *Am. Sci.* **70** (1998) 596–606.
- [40] DEINES, P., “The isotopic composition of reduced organic carbon”, *Handbook of Environmental Isotope Geochemistry*, (FRITZ, P., FONTES, J.C.H., Eds), Elsevier, Amsterdam, Oxford, New York (1980) 329–406.
- [41] HUBNER, H., “Isotope effects of nitrogen in the soil and biosphere”, *Handbook of Environmental Isotope Geochemistry*, Vol. 2, (FRITZ, P., FONTES, J.C.H., Eds), Elsevier Science (1986) 361–425.
- [42] MAYER, B., et al. Sources of nitrate in rivers draining sixteen watersheds in the northeastern U.S.: isotopic constraints, *Biogeochem.* **57/58** (2002) 171–197.
- [43] ANDERSON, C., CABANA, G.,  $\delta^{15}\text{N}$  in riverine food webs: effect of N inputs from agricultural watersheds, *Can. J. Fish. Aquat. Sci.* **62** (2005) 333–340.

- [44] JUNK, W.J., WANTZEN, K.M., “The Flood Pulse Concept: New Aspects, Approaches and Applications – An Update”, Proc. Second International Symposium on the Management of Large Rivers for Fisheries Volume II. (WELCOMME, R., PETR, T., Eds), FAO Regional Office for Asia and the Pacific, Bangkok, Thailand, RAP Publication 2004/17 (2004).
- [45] AMUNDSON, R., AUSTIN, A.T., SCHUUR, E.A.G., YOO, K., MATZEK, V., Global patterns of the isotopic composition of soil and plant nitrogen, *Glob. Biogeochem. Cycles* **17** (2003) 1031–41.
- [46] KENDALL, C., “Tracing sources and cycling of nitrate in catchments”, *Isotope Tracers in Catchment Hydrology* (KENDALL, C., MCDONNELL, J.J., Eds), Elsevier, Amsterdam (1998) 519–576.
- [47] LIU, K.K., KAO, S.J., WEN, L.S., CHEN, K.L., Carbon and nitrogen isotopic compositions of particulate organic matter and biogeochemical processes in the eutrophic Danshuei Estuary in northern Taiwan, *Sci. Total Environ.* **382** (2007) 103–120.
- [48] POST, W.M., PASTOR, J., ZINKE, P.J., STANGENBERGER, A.G., Global patterns of soil nitrogen storage, *Nature* **17** (1985) 613–616.
- [49] VITÒRIA, L., OTERO, N., SOLER, A., CANALS, A., Fertilizer characterization: Isotopic data (N, S, O, C, and Sr), *Environ. Sci. Technol.* **38** (2004) 3254–3262.
- [50] BATEMAN, A.S., KELLY, S.D., Fertilizer nitrogen isotope signatures, *Isot. Environ. Health Stud.* **43** (2007) 237–247.
- [51] ROGERS, K.M., Nitrogen Isotopes as a Screening Tool to Determine the Growing Regime of some Organic and Non-organic Supermarket Produce from New Zealand, *J. Agric. Food Chem.* **56** 11 (2008) 4078–4083.
- [52] KNOX, G.A., *Estuarine Ecosystems: A systems approach*. CRC Press, Boca Raton, Fla. Vol. 1, ISBN 0849369967 (1986).
- [53] PAGE, M., HERON, D., TRUSTRUM, N., Pauatahanui Inlet — analysis of historical catchment land use and land use change, GNS client report 2004/169 (2004).
- [54] GLASBY, G.P., MOSS, R.L., STOFFERS, P., Heavy metal pollution in Porirua Harbour, New Zealand, *N. Z. J. Mar. Freshw. Res.* **24** (1990) 233–237.
- [55] WILLIAMS, J.R., SMITH, M.D., MACKAY, G., Biomass survey and stock assessment of cockles (*Austrovenus stutchburyi*) on Snake Bank, Whangarei Harbour, 2006, New Zealand Fisheries Assessment, Report 2006/38 November 2006, ISSN 1175–1584 (2006).
- [56] ROGERS, K.M., Stable carbon and nitrogen isotope signatures indicate recovery of marine bioata from sewage pollution at Moa Point, New Zealand, *Mar. Poll. Bull.* **46** (2003) 821–827.
- [57] JOLLEY, D.F., MAHER, W.A., KYD, J., Selenium accumulation in the cockle *Anadara trapezia*, *Environ. Poll.* **132** (2004) 203–212.
- [58] PHILLIPS, D.L., KOCH, P.L., Incorporating concentration dependence in stable isotope mixing models, *Oecologia* **130** (2002) 114–125.



- [59] PHILLIPS, D.L., GREGG, J.W., Source partitioning using stable isotopes: coping with too many sources, *Oecologia* **136** (2003) 261–269.
- [60] PHILLIPS, D.L., NEWSOME, S.D., GREGG, J.W., Combining sources in stable isotope mixing models: alternative methods, *Oecologia* **144** (2005) 520–527.
- [61] SAURIAU, P.G., KANG, C.K., Stable isotope evidence of benthic microalgae-based growth and secondary production in the suspension feeder *Cerastoderma edule* (Mollusca, Bivalvia) in the Marennes-Oléron Bay, *Hydrobiologia* **440** (2000) 317–329.
- [62] HEALY, W.B., Pauatahanui Inlet – an environmental study, New Zealand Department of Scientific and Industrial Research, DSIR Information Series 141 (1980) 198.

# **STABLE ISOTOPE SIGNATURES OF CARBON AND NITROGEN TO CHARACTERIZE EXCHANGE PROCESSES AND THEIR USE FOR RESTORATION PROJECTS ALONG THE AUSTRIAN DANUBE**

T. HEIN

Wasser Cluster Lunz,  
Lunz/See, Austria

Institute of Hydrobiology and Aquatic Ecosystem Management,  
University for Natural Resources and Life Sciences,  
Vienna, Austria

E. BONDAR-KUNZE

University of Natural Resources and Applied Life Sciences,  
Vienna, Austria

N. WELTI

Institute of Hydrobiology and Aquatic Ecosystem Management  
Vienna, Austria

## **Abstract**

The size and composition of an organic matter pool and its sources is a fundamental ecosystem property of river networks. River ecosystems are known to receive large amounts of terrestrial organic matter from catchments, still the question is to what extent aquatic sources influence riverine food webs or at least some components of these food webs. To identify different sources and their potential biological availability at the ecosystem level, we propose using stable isotope signatures of carbon and nitrogen and their respective elemental ratios. In this study, we used these parameters to evaluate river restoration measures. The target of the restoration was to improve surface connectivity between the main channel of the Danube downstream from Vienna and a side arm system within a floodplain. Analyses of the natural abundance of stable isotopes revealed that the restored side arm system showed distinct differences in the particulate organic matter pool in relation to hydrological connectivity. At low water levels, aquatic sources dominate in the side arm system, while at high water levels riverine organic matter is the dominating source. At medium connectivity levels aquatic sources also prevail in the side arm, thus an export of bio-available organic matter into the main channel can be expected. Based on these measurements, the increased — but hydrologically controlled — phytoplankton production was assessed and through this information, changes in ecosystem function were evaluated.

## **1. INTRODUCTION**

### **1.1. The role of fluvial systems in nutrient and organic matter flow**

In aquatic ecosystems, the question of sources and fate of organic matter (OM) is of fundamental interest in understanding and thus for managing these ecosystems. River ecosystems act as links in the global matter flow, connecting terrestrial and marine ecosystems, controlling the transport of nutrients and OM from terrestrial sources [1–3], producing organic material within aquatic environments, degrading OM while transporting it downstream [4], and carrying the fingerprint of human activities (e.g. Ref. [5]). During this passage, significant amounts of terrestrial carbon is respired in fluvial systems [6], indicating the high potential of riverine ecosystems to degrade terrestrial OM.

On the other hand, areas of high turnover such as floodplains, riverine wetlands and riparian zones are key components contributing to the aquatic productivity of fluvial ecosystems [7–10] and thus these areas act as biogeochemical hot spots [11, 12]. They also represent functional retention areas [13] which control and maintain river water quality [14–17]. The self-purification capacity, and accordingly, riverine and riparian food webs, are influenced to a strong extent by the variable mixture of OM sources with different bio-availability [18].

## **1.2. Changes to natural water regimens and their effects on river ecosystems**

Retention areas frequently connected to the riverine flow regime substantially support local aquatic production at water levels below bankfull [19]. Distance to the main channel and water levels explain the duration and frequency of hydrological connectivity of these subsystems during the year [20]. River systems and their retention zones can be viewed as open ecosystems dynamically linked longitudinally, laterally and vertically by hydrological and geomorphological processes [21–22]. Increasing residence time as well as increasing contact zones in retention areas (i.e., water–sediment contact) are positively correlated to the efficiency of nutrient and carbon transformation in river ecosystems. These positive relationships occur both in the main channel itself and in riparian and floodplain zones [23–26].

Any change in natural water regimes affects the biogeochemistry of riparian and instream zones, as well as their ability to cycle and mitigate nutrient fluxes originating from upstream and/or upslope. In this context, human activities have markedly altered environmental conditions and will continue to do so in the future. Numerous anthropogenic activities (such as dams, main channel regulation and flood protection dykes) have led to river ecosystem fragmentation and habitat destruction, disrupting the structure and functioning of these lotic ecosystems (e.g. Refs [27, 28]). Loss of retention areas combined with increased nutrient input has significantly decreased nutrient and OM retention capacity along river ecosystems; outputs have even altered coastal ecosystems, as seen for the Black Sea coast [29] and the Gulf of Mexico [30].

In the last 20 years, deterioration of river ecosystem functioning has prompted numerous rehabilitation and restoration measures based on the assessment of ecological integrity (e.g. Ref. [31]). Most have aimed at increasing the spatial heterogeneity of these ecosystems [32]. However, a more integrated approach, including restoration of landscape dynamics and key ecosystem processes such as carbon and nutrient retention, is necessary [33, 34]. Large scale rehabilitation and restoration projects must therefore also consider altered nutrient and OM dynamics (such as in the Danube Delta; see Ref. [35]) or aim to reduce nutrient transport in river corridors by increased nutrient retention (Kissimmee restoration project [36], Mississippi–Ohio–Missouri [37]). Generally, river restoration and rehabilitation schemes that integrate biogeochemical processes attain a functional ecological integrity of lotic networks and associated coastal areas at larger scales [38].

Scientific debate about the role of allochthonous and autochthonous carbon sources in fuelling and structuring aquatic food webs has promoted research on characterizing OM, tracking its sources and estimating its utilization over the last 10 to 25 years [39, 40]. This issue not only has implications for research; it has a high relevance for water and ecosystem management, especially in regulated rivers [19, 41]. Averaged over the year, autochthonous autotrophy apparently provides >50% of the energy supporting metazoan production in channel sites and retention areas in some arid river systems (e.g. Ref. [42]). Dominance of allochthonous organic carbon occurs where autotrophs (such as algae and water plants) are limited, for example by low light levels due to a dense, enclosing canopy in headwaters, certain geological features, or

high inorganic turbidity. Despite the low number of studies in large river systems, three general concepts of ecosystem functioning are widely used, each stressing the dominance of a principal OM source controlling riverine food webs: the River Continuum Concept (RCC) [43], the Flood Pulse Concept (FPC) [44] and the Riverine Productivity Model (RPM) [45, 46].

The RCC stipulates that primary food sources along the longitudinal dimension of the river network are: (a) allochthonous organic matter (principally riparian leaves) in headwater streams with a heavy canopy cover; (b) benthic autotrophs in shallow mid-order rivers; (c) fine particulate organic matter (FPOM) in large rivers, derived from terrestrial OM via leakage from upstream food webs. The trophic basis of production is expected to shift from a relative emphasis on benthic to pelagic autotrophs from headwaters to river mouth [47].

In the FPC, Junk et al. [44] argued that with increasing floodplain size and river discharge, flood predictability and duration increase, resulting in large areas along the aquatic terrestrial transition zone characterized by a greater proportion of area which is periodically lentic rather than lotic. Adaptations of biota in these river–floodplain ecosystems are distinct from those in either stable lotic or lentic ecosystems. According to the FPC, seasonal floodplain inundation drives ecosystem dynamics, with most secondary production directly or indirectly attributed to aquatic macrophytes and periodically submerged floodplain vegetation. Thus, the flood pulse in tropical systems and the flow pulse in temperate systems are two important factors driving ecosystem processes relating to OM processing at the landscape level.

The RPM [45] emphasizes the refractory nature of transported organic material, and proposes that consumers in large rivers preferentially assimilate labile autochthonous production, and to a lesser degree moderately labile direct inputs from the riparian zone, rather than allochthonous carbon leaked from upstream inefficiencies. In its original form [45], the RPM was intended to apply to large rivers with naturally constricted channels. The revised RPM [46] expanded its application and simultaneously increased the predicted relative importance of autochthonous production to consumers, stating that overall metazoan production and species diversity in mid to higher trophic levels of large rivers is autochthonous primary production entering food webs via algal-grazer and decomposer pathways [40].

### **1.3. Sources of organic matter and the application of isotopes**

The key question in ecological research at this point has been, “What sources of OM support which elements of aquatic food webs and under what hydrological conditions?” For management purposes, the question is what OM sources supply different compartments of riverine communities and thus point to sensitive areas and moments (such as shore line or riparian structures during medium flow in the Austrian Danube stretch, shown by Schiemer et al. [19]).

One efficient approach to elucidate the sources and fate of OM in riverine communities is to use the natural abundance of stable isotopes (Table 1, [48]). Finlay [49] showed that consumer  $\delta^{13}\text{C}$  values in temperate headwaters and medium sized rivers were more strongly related to algal than to terrestrial  $\delta^{13}\text{C}$  values. A clear transition from terrestrial to algal carbon sources with increasing stream order was found, which is linked to decreasing canopies and associated increases in algal productivity. In large rivers, pulsing surface connectivity affects particulate organic matter (POM) quality by stimulating algal primary production and the input of additional terrestrial material. Hence, aquatic OM resources change their isotope signals and thus, through these analyses, the potential subsidizing effects for main channel communities has

TABLE 1. TYPICAL COMPOSITIONAL VALUES OF MAJOR ORGANIC MATTER SOURCES <sup>1</sup>

Organic matter sources	$\delta^{13}\text{C}$ (‰)	$\delta^{15}\text{N}$ (‰)	$\delta^{34}\text{S}$ (‰)	C:N (at.)
Heterotrophic bacteria	Similar to substrate	-15 to +20	-15 to +20	4 to 8
Freshwater autotrophs		-15 to +20	-10 to +33	5 to 12
Periphyton	-35 to -18 (-47 to -8)			5 to 8
Phytoplankton	-32 to -23 (-42 to -19)			
Macrophytes <sup>2</sup>	-27 to -20	-15 to +20	-10 to +33	10 to >50
Soil Organic Matter		0 to +5	0 to +5	8 to >25
C3	-27 (-32 to -22)		(-30 to +35)	
C4	-13 (-16 to -9)			
Terrestrial plants		-3 to -7	0 to +5	15 to >50
C3	-27 (-32 to -22)	(-10 to +10)	(-10 to +20)	
C4	-13 (-16 to -9)			

<sup>1</sup> The ranges of observed values are in parentheses: from Ref. [48].

<sup>2</sup> Excluding bryophytes.

been shown in arid zone rivers [42], and pulsed resource availability effects have been shown in temperate rivers [50, 51].

The source of energy fuelling large river food webs has been more controversial. A popular view (such as that of Sedell et al. [52], and the flood pulse concept of Junk et al. [44]) has been that terrestrial detritus and aquatic macrophytes on submerged floodplains (rather than FPOM from upstream) are the predominant OM sources in floodplain rivers. Other researchers have concluded from stable isotope data that the major annual energy source supporting overall metazoan production of most constricted and floodplain rivers tends to be autochthonous primary production (see Refs [42, 53]. This production enters food webs via algal-grazer and decomposer pathways [46]. However, a decomposer (microbially mediated) food pathway may process most of the transported, allochthonous and autochthonous carbon and contribute substantially to the heterotrophic state ( $P/R < 1$ ) of many large rivers [46]. A weak coupling between microbial and metazoan production has also been noted by Lewis et al. [54] and Delong and Thorp [55].

Consequently, our research questions have been: (a) how can OM be characterized by bulk parameters such as elemental ratios and stable isotopes; and (b) how are OM dynamics related to discharge conditions in a side arm. Thus, the aim of our paper is to present the use of stable isotopes to quantify key ecosystem processes related to changed hydrologic exchange conditions. Furthermore, we discuss the potential use of stable isotopes in river restoration projects and river management.

## **2. STUDY AREA**

### **2.1. Description of the Danube River**

The Danube is one of the main drainage systems in Europe (817 000 km<sup>2</sup>). The Danube in Austria drains 104 000 km<sup>2</sup> and is of the 9th river order. Flow is characterized by an alpine regime with variable and stochastic patterns. The mean discharge is 1900 m<sup>3</sup>/s ( $Q_{95}$ : 950 m<sup>3</sup>/s,  $Q_1$ : 5040 m<sup>3</sup>/s). Like all large rivers in the industrialized world [56, 57] the ecology of the Danube has been considerably affected by changed land use, by pollution and most importantly by hydro-engineering [58]. The 50 km river reach downstream from Vienna, although strongly impacted by regulation, represents one of the last remnants of alluvial landscape in Europe and was declared a National Park in 1996. Its importance has been described in a number of papers [59, 60]. Here, the key functional attributes of floodplains — hydrological dynamics, flood pulses and bed load transport — are partially operative.

### **2.2. Floodplain restoration measures**

A large scale restoration programme was initiated to restore the hydrological connectivity of former side arms along the free flowing stretch of the Danube downstream of Vienna. The floodplain segment Regelsbrunn is dominated by a former river channel that was severed upstream from the Danube after main regulation of the river in the 19th century. Before restoration, flood pulses were characterized by short and intense upstream surface connections of only a few days during spates (more than 5000 m<sup>3</sup>/s, 3 to 6 d/a). See page and groundwater from the river have supplied the area above mean water. Several weirs in the side arms have divided the water body into distinct basins [61].

The main goal of restoration programmes in the Alluvial Zone National park is to increase the upstream surface connection with the river and connectivity within side arms to enhance the duration of flow conditions. The enhancement of connectivity with the Danube was established by lowering riverside embankments and by adding artificial openings in different inflow areas [58]. Within the side arms, weirs have been lowered and equipped with larger openings. In the Regelsbrunn reach, surface connectivity with the river was established at water levels 0.5 m below mean water levels ( $MW_{85}$ , Austrian River Authority, unpublished report).

## **3. METHODS**

### **3.1. Data collection and analyses**

Sampling stations were located within the main channel and the floodplain reaches of Regelsbrunn before and after restoration and along the isolated floodplain at Lobau (years 1995–2000). The range in water levels and temperature showed no significant difference between stations and their connectivity levels. Sampling in Regelsbrunn covered the years 1991, 1995, 1996, 1997 and the year 1999/2000, while in Lobau the years 1997, 1999 and 2000 were sampled [61–63]. Temperature, dissolved oxygen, conductivity and water levels were recorded in the field (portable meters: WTW probes Series 330). Water was passed through a glass-fibre filter (APF/F, Millipore) within three hours after sampling for nutrient analysis but was used unfiltered for the determination of total phosphorus (Ptot) and nitrogen (Ntot) [64]. Chloro-



phyll-a concentrations were analysed according to Lorenzen [65]. Samples for sediment, water plants and algae were taken from the Regelsbrunn area in 1997 and 1999.

### 3.2. Elemental analysis and stable isotope measurements

Samples for organic matter (OM) analysis were taken using acid rinsed 5-L polyethylene bottles between 0.5 and 1 m depth. Within three hours of sampling, the water was filtered through combusted (490°C for 2 hours) glass-fibre filters (47 mm Millipore APF/F filters, Molsheim, France). These filters were used to determine particulate organic carbon (POC) and particulate organic nitrogen (PON) (100–300 mL filtered). For dissolved organic carbon (DOC) analyses, 20 mL of the filtrate was collected in acid rinsed, combusted glass vials. Total organic carbon (TOC) was the sum of POC plus DOC.

Samples for POC and PON were dried at 60°C for 24 hours then placed in a fume hood over concentrated HCl (37%) to remove inorganic constituents prior to being prepared for elemental analysis [66]. Sufficient time is needed to secure the removal of all inorganic carbon (minimum of three hours). Alternatively, an amount of CaCO<sub>3</sub> comparable to the sample weight can be placed on a filter and, together with the sample, a reaction could take place until all carbonate is removed. Sediment, plant, benthic algae and leaves/litter samples were dried at 60°C and ground to fine powder; respective sub-samples (1–2 g) were acidified with 1N HCl to remove all inorganic carbon [67].

The glass fibre filters bearing samples for POC and PON determination were ground to a fine powder in a ball mill (Retsch MM2, Vienna, Austria) and analysed using continuous flow gas isotope ratio mass spectrometry. The elemental analyser (EA 1200, CE Instruments, Italy) was interfaced via a ConFlo II device (Finnigan MAT, Bremen, Germany) to the gas isotope ratio mass spectrometer (Delta<sup>PLUS</sup>, Finnigan MAT, Bremen, Germany). The standard deviation of repeated measurements of  $\delta^{13}\text{C}$  values of a laboratory standard was 0.10‰ versus Vienna-Pee Dee Belemnite (V-PDB). The  $\delta^{13}\text{C}$  was calculated as follows:

$$\delta^{13}\text{C} = (R_{\text{sample}}/R_{\text{standard}} - 1) \times 1000 \text{ [‰ vs. PDB]} \quad (1)$$

where  $R$  is the ratio of mass 45/mass 44 (carbon). Abundance of  $\delta^{13}\text{C}$  and  $\delta^{15}\text{N}$  is expressed in relation to the international standard Vienna-Pee Dee Belemnite (V-PDB) and atmospheric N<sub>2</sub> (at-air), respectively. The standard deviation for  $\delta^{15}\text{N}$  values of repeated samples was calculated to be 0.15‰ vs. atmospheric N<sub>2</sub> [68].

## 4. RESULTS AND DISCUSSION

Recent analyses of seston composition in large rivers using stable isotope and C:N ratios, has demonstrated that living and detrital autochthonous matter, primarily phytoplankton, is a major constituent of transported POM. This predominance of autochthonous OM in seston has been shown for the Mississippi, Colorado, Rio Grande, and Columbia Rivers [69], for a floodplain reach of the Danube River [51], and for the Upper Mississippi's main channel during the summer [70]. Although seston composition varies among seasons, discharge conditions and rivers, the predominance of autochthonous OM in seston extends for much of the year. The importance of allochthonous carbon to metazoans as a whole for tropical and temperate floodplain rivers (e.g. Refs [53, 54]) has also been challenged recently. These studies support the domi-

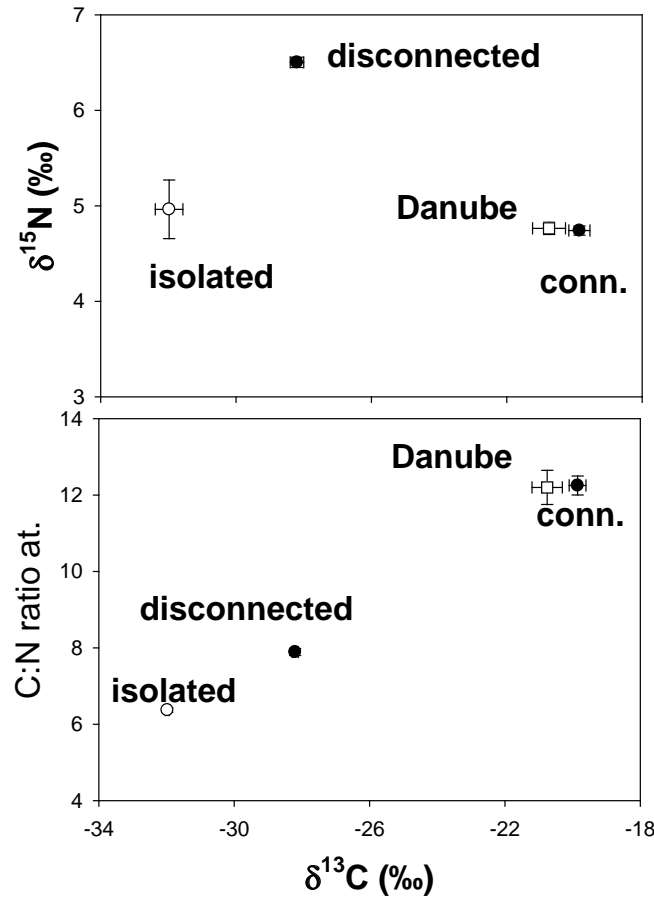

FIG. 1. Lower panel:  $\delta^{13}\text{C}$  values versus atomic C:N ratio. Upper panel: isotopic signatures of  $\delta^{13}\text{C}$  and  $\delta^{15}\text{N}$  (mean  $\pm$  SE) measured under different hydrological conditions (closed symbols indicate the restored floodplain RB ( $n=23$ ), open symbols indicate reference values from the isolated floodplain of Lobau ( $n=12$ ) and the Danube River main channel ( $n=14$ ). Modified based on Ref. [68].

TABLE 2. POM QUALITY OF THE RESTORED FLOODPLAIN AT THE OUTFLOW (MEAN VALUES  $\pm$  STANDARD DEVIATION) FOR DIFFERENT DISCHARGE CLASSES, DEFINED BY THE HEIGHT OF THE INFLOW AREAS<sup>a</sup>

	Discharge class	C:N at. <sup>b</sup>	$\delta^{13}\text{C}$ (‰)	Detrital contribution (%)
Floodplain	Low ( $n=38$ )	$7.2 \pm 1.4$	$-30 \pm 2.4$	$47 \pm 17$
	medium ( $n=25$ )	$7.7 \pm 1.1$	$-27 \pm 2.7$	$66 \pm 11$
	high ( $n=7$ )	$11.9 \pm 3.2$	$-20 \pm 2.5$	$88 \pm 8$

<sup>a</sup> Low: up to mean water levels of the river channel, medium from mean water to annual high water, high: above annual high water levels; see Ref. [51] for details.

<sup>b</sup> at. — atomic ratio.

nant role of grazer and detrital consumption of algae in floodplain food webs. Aspetsberger et al. [68] and Hein et al. [51] focused on: (a) how OM can be characterized by bulk parameters such as elemental ratios and stable isotopes; (b) how OM dynamics are related to discharge conditions in a side arm. In both papers we demonstrated that algal and terrestrial sources were characterized by differing signatures and ratios, and that they varied in accordance with differing discharge conditions. During floods terrestrial material from the catchment dominated,

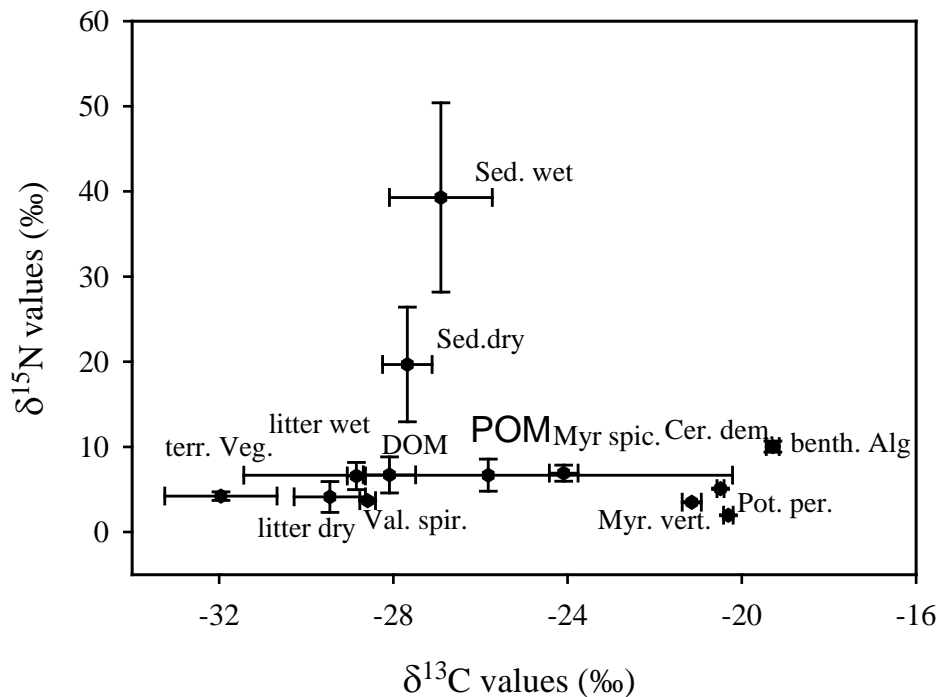

FIG. 2.  $\delta^{13}\text{C}$  values versus  $\delta^{15}\text{N}$  values of POM sources and DOM in the restored floodplain,  $n = 5$ . Circles indicate macrophytes, squares, terrestrial vegetation, and diamonds, sediment samples. Abbreviations: benth. Alg.: benthic algae (*Spirogyra* sp.); Cer. dem.: *Ceratophyllum demersum*; Myr. spic.: *Myriophyllum spicatum*; Myr. vert.: *Myriophyllum verticillatum*; Pot. Per.: *Potamogeton perfoliatus*; Val. spir.: *Valisneria spiralis*; sed.: sediment; terr. Veg.: terrestrial vegetation — litter (species not specified).

while during low to medium discharge conditions in the floodplain a high contribution of OM of local aquatic origin was found (Table 2, Fig. 1).

The depleted stable isotope values are in the range of various aquatic primary producers measured in the floodplain area (Fig. 2) and lie within the range of values reported by [48]. The enriched values found for carbon isotope signatures of transported POM during flooding agreed with the findings of [71], who proved rather enriched values in Alpine region streams.

Differences in the nitrogen isotope signature of POM were related to bacterial secondary production rates in the side arm [68]. The high supply of riverine nitrate, along with lower microbial availability of dissolved OM, lead to lower nitrogen isotope fractionation during high flows. During medium to low connectivity, however, mainly microbial processes lead to increased nitrogen isotope fractionation (compare to Ref. [72]). Using the plankton contribution to POM and the carbon isotope signature, a carbon budget for the Regelsbrunn side arm clearly demonstrated transformation capacity during medium flows. This underlined the relevance of plankton sources as a subsidy for main channel conditions [51, 73]. Using the budget approach, the relevance of this local production in relation to total amount transported was demonstrated (Fig. 3). Before restoration, transport was restricted to short periods of flooding, when terrestrial material dominated the POM. Since restoration, however, a greater proportion of plankton-derived material is additionally transported to the main stem at medium water stages. The export of autochthonous POC increased by more than 100% after restoration,

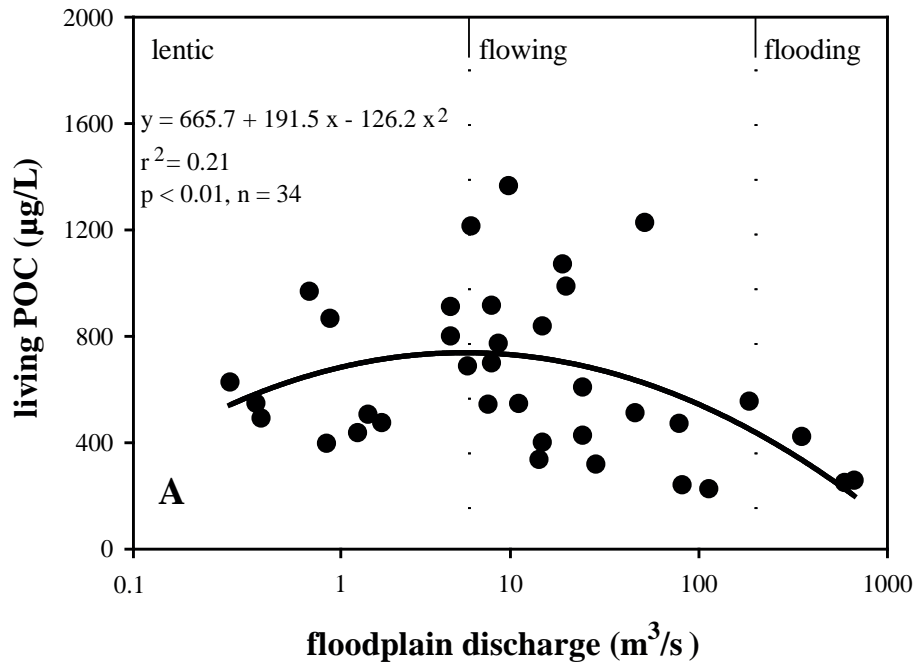

FIG. 3. Living POC concentration estimates versus floodplain discharge at Regelsbrunn. Vertical reference lines indicate hydrological conditions at Regelsbrunn. Total transport through the floodplain is approx. 200 mt/a. From Ref. [51].

based on our export estimations and the longer duration of the upstream surface connection compared to pre-restoration conditions. The open cycling system shifted gradually to an open spiralling system [74]. Connected floodplains therefore increase total OM retention and transformation in regulated rivers and are of considerable importance for the support of riverine biota, as has also been shown for inshore retention structures [19].

## 5. IMPLICATION FOR RIVER MANAGEMENT

Large rivers with relatively complex morphological structures and hydrological exchange patterns have the potential for an intense turnover of OM and inorganic solutes due to high algal and microbial activity [75]. Analysis of biogeochemical budgets indicates that river networks can remove 37–76% of the total N-input mainly via denitrification, with a large contribution from high-order river sections [76]. Large rivers therefore substantially affect the N budgets of catchments [77], even if water depth-related retention in river channels decreases along a river continuum [30, 78]. Large rivers also process high amounts of organic carbon [4, 79] and thus play a crucial role in the carbon cycling of estuarine and coastal regions [80]. It is largely unknown how this metabolism is related to specific morphological structures and changes in hydrological connectivity present in rivers impacted by human alterations, especially in the role of lateral linkages. Changes over the whole range of connectivity depend largely on the type of response function for each parameter and in most cases not only quantity, but also quality is affected. Stable isotope approaches offer great potential in investigating these changes, particularly for those related to changes in OM quality or the degree of biologic transformation of various sources.

One of the major challenges for rehabilitation and restoration programmes of large river floodplain systems is that success requires profound insight into ecological functioning. The coupling of hydrology and ecological processes can play an important role in understanding large scale biogeochemical processes and in using ecosystem services for more effective river management. In urban and industrial areas, more natural exchange processes with retention areas can support other engineering based solutions to achieve required water quality goals [81]. The presented side arm reopening in the Austrian Danube provides an example of rehabilitation at the reach scale: rare lotic elements of the former braided reach were reintroduced during medium to high flows. Within the side arm, a more natural mass balance between storage, transformation and export of nutrients and OM was established, as shown by the stable isotope signatures [51]. Increased nutrient transformation and retention also represents a socio-economically important, green service of the river corridor [82]. During floods loss of inundation area, combined with a lateral link to terrestrial components of the riverine landscape [83], can be expected to reduce retention capacity compared with pre-regulation times. Hence, the rehabilitation of retention areas along the course of the river can affect local biogeochemical processes and enhance overall transformative capacity. Within the framework of these restoration activities, the role of OM supply and its sources is a key issue that will aid in our understanding of immediate and long term effects on the biota and the carbon balance of these systems.

## 6. CONCLUSIONS

Our results show that bulk parameters of POM clearly indicate changes in the dominating source of OM in side arm systems under different hydrological conditions. While at low water levels, aquatic sources dominate the POM pool in the side arm system, high flows transport terrestrial material from upstream regions in the catchment and represent the major fraction within the side arm system. Thus, a combined approach of elemental analysis and stable isotope signatures is an efficient tool in the differentiation of hydrological phases and the dominant carbon pools and processes in river floodplains. This information provides a basis to understand how food webs are controlled and maintained under different environmental conditions and thus aids in understanding the effects of different management activities, such as restoration measures, as shown in the case study of the Austrian Danube.

## ACKNOWLEDGMENT

This work was funded by the Austrian Science Fund (grant # P11720 bio, #P19907-B17), by the Austrian River Authority (in Regelsbrunn the project ‘Gewaesservernetzung Regelsbrunn’) and by the National Park Authority (Life98NAT/A/005422). A. Aschauer, G. Heiler, C. Holarek, H. Kraill, P. Riedler and M. Schagerl contributed to data collection and analysis. The manuscript was written based on an IAEA technical meeting held in Vienna in October 2007.

## REFERENCES

- [1] BENNETT, E.M., CARPENTER, S.R., CARACO, N.F., Human impact on erodible phosphorus and eutrophication: A global perspective, *Bioscience* **51** (2001) 227–234.

- [2] SEITZINGER, S.P., et al., Global patterns of dissolved inorganic and particulate nitrogen inputs to coastal systems: Recent conditions and future projections, *Estuaries* **25** (2002) 640–655.
- [3] TOWNSEND-SMALL, A., McCLAIN, M.E., BRANDES, J.A., Contributions of carbon and nitrogen from the Andes Mountains to the Amazon River: Evidence from an elevational gradient of soils, plants, and river material, *Limnol. Oceanogr.* **50** (2005) 672–685.
- [4] HEDGES, J.I., et al., Organic matter in Bolivian tributaries of the Amazon River: A comparison to the lower mainstream, *Limnol. Oceanogr.* **45** (2000) 1449–1466.
- [5] ROSENBERG, D.M., McCULLY, P., PRINGLE, C.M., Global-scale environmental effects of hydrological alterations: Introduction, *Bioscience* **50** (2000) 746–751.
- [6] BATTIN, T.J., et al., Biophysical controls on dissolved organic carbon in fluvial networks, *Nature Geoscience* (2008).
- [7] HYNES, H.B.N., The stream and its valley, *Verh. Int. Ver. Theor. Angew. Limnol.* **19** (1975) 1–15.
- [8] NAIMAN, R.J., DÉCAMPS, H., The ecology of interfaces: riparian zones, *Annu. Rev. Ecol. System.* **28** (1997) 621–658.
- [9] REN, T., ROY, R., KNOWLES, R., Production and consumption of nitric oxide by three methanotrophic bacteria, *Appl. Environ. Microbiol.* **66** (2000) 3891–3897.
- [10] FISCHER, H., KLOEP, F., WILCZEK, S., PUSCH, M.T., A river's liver — microbial processes within the hyporheic zone of a large lowland river, *Biogeochemistry* **76** 2 (2005) 349–371.
- [11] McCLAIN, M.E., “The Application of Ecohydrological Principles for Better Water Resources Management in South America”, *The Ecohydrology of South American Rivers and Wetlands*, IAHS Special Publication (2002).
- [12] FORSHAY, K.J. STANLEY, E.H., Rapid nitrate loss and denitrification in a temperate river floodplain, *Biogeochemistry* **75** 1 (2005) 43–64.
- [13] CARLING, P.A., The Nature of the Fluid Boundary-Layer and the Selection of Parameters for Benthic Ecology, *Freshw. Biol.* **28** 2 (1992) 273–284.
- [14] PETERJOHN, W.T., CORRELL, D.L., Nutrient dynamics in an agricultural watershed: Observations on the role of a riparian forest, *Ecology* **65** (1984) 1466–1475.
- [15] BRINSON, M.M., BRADSHAW, H.D., KANE, E.S., Nutrient Assimilative Capacity of an Alluvial Floodplain Swamp, *J. Appl. Ecol.* **21** 3 (1984) 1041–1057.
- [16] PINAY, G., DECAMPS, H., The role of riparian woods in regulating nitrogen fluxes between the alluvial aquifer and surface water: A conceptual model, *Regulated Rivers-Research Management* **2** (1988) 507–516.
- [17] TRISKA, F.J., KENNEDY, V.C., AVANZINO, R.J., ZELLWEGER, G.W., BENCALA, K.E., Retention and transport of nutrients in a third-order stream in northwestern California: hyporheic processes, *Ecology* **70** (1989) 1893–1905.



- [18] HOENIGHAUS, D.J., WINEMILLER, K.O., AGOSTINHO, A.A., Landscape-scale hydrologic characteristics differentiate pattern of carbon flow in large river food webs, *Ecosystems* **10** 6 (2007) 1019–1033.
- [19] SCHIEMER, F., KECKEIS, H., RECKENDORFER, W., WINKLER, G., The inshore retention concept and its significance for large rivers, *Arch. Hydrobiol. Suppl.* **135** (2001) 509–516.
- [20] TOCKNER, K., MALARD, F., WARD, J.V., An extension of the flood pulse concept, *Hydrol. Process.* **14** (2000) 2861–2883.
- [21] WARD, J.V., The four-dimensional nature of lotic ecosystems, *J. N. Am. Benthol. Soc.* **8** (1989) 2–8.
- [22] WARD, J.V., “Riverine-wetland interactions”, *Freshwater wetlands and wildlife* (SHARITZ, R.R., GIBBONS, J.W., Eds), USDOE Office of Scientific and technical information, Tennessee (1989) 385–400.
- [23] PONNAMPERUMA, F.N., The chemistry of submerged soils, *Adv. Agro.* **24** (1972) 29–96.
- [24] HILL, A.R., Denitrification in the nitrogen budget of a river ecosystem, *Nature* **281** (1979) 291–292.
- [25] JONES, J.B., HOLMES, R.M., Surface-subsurface interactions in stream ecosystems, *Trends Ecol. Evol.* **11** (1996) 239–242.
- [26] VALETT, H.M., MORRICE, J.A., DAHM, C.N., CAMPANA, M.E., Parent lithology, surface-groundwater exchange and nitrate retention in headwater streams, *Limnol. Oceanogr.* **41** (1996) 333–345.
- [27] FRIEDL, G., WÜEST, A., Disrupting biogeochemical cycles — Consequences of damming, *Aquat. Sci.* **64** (2002) 55–65.
- [28] GERGEL, S.E., CARPENTER, S.R., STANLEY, E.H., Do dams and levees impact nitrogen cycling? Simulating the effects of flood alterations on floodplain denitrification, *Glob. Change Biol.* **11** 8 (2005) 1352–1367.
- [29] SCHMIDT, K.F., Ecology: A True-Blue Vision for the Danube, *Science* **294** (2001) 1444–1447.
- [30] ALEXANDER, R.B., SMITH, R.A., SCHWARZ, G.E., Effect of stream channel size on the delivery of nitrogen to the Gulf of Mexico, *Nature* **403** (2000) 758–761.
- [31] JUNGWIRTH, M., MUHAR, M., SCHMUTZ, S., Re-establishing and assessing ecological integrity in riverine landscapes, *Freshw. Biol.* **47** (2002) 867–887.
- [32] HENRY, C., AMOROS, C., ROSET, N., Restoration ecology of riverine wetlands: A 5-year post-operation survey on the Rhone River, France, *Ecol. Engin.* **18**: 543–554.
- [33] PEDROLI, B., DE BLUST, G., VAN LOOY, K., VAN ROOIJ, S., Setting targets in strategies for river restoration, *Landscape Ecol.* **17** (2002) 5–18.

- [34] HOHENSINNER, S., HABERSACK, H., JUNGWIRTH, M., ZAUNER, G., Reconstruction of the characteristics of a natural alluvial river-floodplain system and hydrogeomorphological changes following human modifications: the Danube River (1912–1991), *River Res. Appl.* **20** (2004) 25–41.
- [35] BUIJSE, A.D., et al., Restoration strategies for river floodplains along large lowland rivers in Europe, *Freshw. Biol.* **47** (2002) 889–907.
- [36] DAHM, C.N., CUMMINS, K.W., VALETT, H.M., COLEMAN, R.L., An ecosystem view of the restoration of the Kissimmee River, *Restoration Ecology* **3** (1995) 225–238.
- [37] MITSCH, W.J., DAY, J.W., Restoration of wetlands in the Mississippi–Ohio–Missouri (MOM) River Basin: Experience and needed research, *Ecol. Engin.* **26** 1 (2006) 55–69.
- [38] BRADSHAW, A.D., Underlying principles of restoration, *Can. J. Fish. Aquat. Sci.* **53** (1996) 3–9.
- [39] THORP J.H., THOMS, M.C., DELONG, M.D., The riverine ecosystem synthesis: biocomplexity in river networks across space and time, *River Res. Appl.* **22** 2 (2006) 123–147.
- [40] HOEINGHAUS, D., WINEMILLER, K., AGOSTINHO, A., Landscape-Scale Hydrologic Characteristics Differentiate Patterns of Carbon Flow in Large-River Food Webs, *Ecosystems* **10** 6 (2007) 1019–1033.
- [41] HEIN, T., RECKENDORFER, W., THORP, J., SCHIEMER, F., The role of slackwater areas for biogeochemical processes in rehabilitated river corridors: examples from the Danube, *Arch. Hydrobiol., Large Rivers Supplement* **15** (2005) 425–442.
- [42] BUNN, S.E., DAVIES, P.M., WINNING, M., Sources of organic carbon supporting the food web of an arid zone floodplain river, *Freshw. Biol.* **48** 4 (2003) 619–635.
- [43] VANNOTE, R.L., MINSHALL, G.W., CUMMINS, K.W., SEDELL, J.R., CUSHING, C.E., The river continuum concept, *Can. J. Fish. Aquat. Sci.* **37** (1980) 130–137.
- [44] JUNK, W.J., BAYLEY, P.B., SPARKS, R.E., “The flood-pulse concept in river-floodplain systems”, *Proc. Int. Large River Symposium, LARS* (DODGE, D.P., ed.), Canadian Special Publication in Fisheries and Aquatic Sciences **106** (1989) 110–127.
- [45] THORP, J.H., DELONG, M.D., The riverine productivity model: an heuristic view of carbon sources and organic processing in large river ecosystems, *Oikos* **70** 2 (1994) 305–308.
- [46] THORP, J.H., DELONG, M.D., Dominance of autochthonous autotrophic carbon in food webs of heterotrophic rivers, *Oikos* **9** (2002) 543–550.
- [47] DELONG M.D., THORP, J.H., Significance of instream autotrophs in trophic dynamics of the Upper Mississippi River. *Oecologia* **147** 1 (2006) 76–85.
- [48] FINLAY, J.C., KENDALL, C., “Stable isotope tracing of temporal and spatial variability in organic matter sources to freshwater ecosystems”, *Stable Isotopes in Ecology and Environmental Science* ( MICHENER, R., LAJTHA, K., Eds), (2007).
- [49] FINLAY, J.C., Stable-carbon-isotope ratios of river biota: implications for energy flow in lotic food webs. *Ecology* **82** (2001) 1052–1064.

- [50] DELONG M.D., THORP, J.H., GREENWOOD, K.S., MILLER, M.C., Responses of consumers and food resources to a high magnitude, unpredicted flood in the upper Mississippi River basin, *Regul. Rivers: Res. Manage.* **17** 3 (2001) 217–234.
- [51] HEIN, T., BARANYI, C., HERNDL, G.J., WANEK, W., SCHIEMER, F., Allochthonous and autochthonous particulate organic matter in floodplains of the River Danube: the importance of hydrological connectivity, *Freshw. Biol.* **48** (2003) 220–232.
- [52] SEDELL, J.R., RICHEY, J.E., SWANSON, F.J., The RCC: a basis for expected ecosystem behaviour of very large rivers?, *Can. Suppl. Publ. Fish. Aquat. Sci.* **106** (1989) 49–55.
- [53] HAMILTON, S.K., LEWIS, W.M.J., SIPPEL, S.J., Energy sources for aquatic animals in the Orinoco River floodplain: evidence from stable isotopes, *Oecologia* **89** (1992) 324–330.
- [54] LEWIS, W.M.J., HAMILTON, S.K., RODRÍGUEZ, M.A., SAUNDERS, J.F., LASI, M.A., Foodweb analysis of the Orinoco floodplain based on production estimates and stable isotope data, *J. N. Am. Benthol. Soc.* **20** (2001) 241–254.
- [55] DELONG M.D., THORP, J.H., pers. comm. (2006).
- [56] PETTS, G.E., MOLLER, H., ROUX, A.I., Historical changes in large alluvial rivers: Western Europe, Wiley, Chichester (1989).
- [57] WARD, J.V., Riverine landscapes: biodiversity patterns, disturbance regimes, and aquatic conservation, *Biol. Conserv.* **83** (1998) 269–278.
- [58] SCHIEMER, F., BAUMGARTNER, C., TOCKNER, K., Restoration of floodplain rivers: The Danube restoration project, *Regul. Rivers: Res. Manage.* **15** (1999) 231–244.
- [59] TOCKNER, K., SCHIEMER, F., WARD, J.V., Conservation by restoration: The management concept for a river-floodplain system on the Danube River in Austria, *Aquatic Conservation: Mar. Freshw. Ecosyst.* (1998).
- [60] SCHIEMER, F., BAUMGARTNER, C., TOCKNER, K., The Danube restoration project: conceptual framework, monitoring program and predictions on hydrologically controlled changes. *Regul. Rivers: Res. Manage.* **15** (1999) 231–244.
- [61] HEILER, G., HEIN, T., SCHIEMER, F., Hydrological connectivity and flood pulses as the central aspects for the integrity of a river-floodplain system, *Regul. Rivers: Res. Manage.* **11** (1995) 351–361.
- [62] HEIN, T., et al., The Danube restoration project: functional aspects and planktonic productivity in the floodplain system, *Regul. Rivers: Res. Manage.* **15** (1999) 259–270.
- [63] HEIN, T., Ökologische Begleituntersuchung Umbau Gänshaufentraverse, Untere Lobau: Fachbereich Hydrochemie, Institut für Ökologie und Naturschutz, Wien (2002).
- [64] GOLTERMAN, H.L., CLYMO, R.S., OHNSTAD, M.A.M., Methods for physical and chemical analysis of freshwater, Blackwell Scientific, Oxford (1978).
- [65] LORENZEN, C.J., Determination of chlorophyll and phaeopigments: spectrometric equations. *Limnol. Oceanogr.* **12** (1967) 343–346.

- [66] CIFUENTES, L.A., et al., Isotopic and Elemental Variations of Carbon and Nitrogen in a Mangrove Estuary, *Estuar. Coast. Shelf Sci.* **43** (1996) 781–800.
- [67] MICHENER, R., LAJTHA, K., *Stable Isotopes in Ecology and Environmental Science*, Oxford, Blackwell (2007).
- [68] ASPETSBERGER, F., et al., Particulate organic matter dynamics in a river floodplain system: impact of hydrological connectivity, *Arch. Hydrobio.* **156** (2002) 23–42.
- [69] KENDALL, C., SILVA, S.R., KELLY, V.J., Carbon and nitrogen isotopic compositions of particulates organic matter in four large river systems across the United States, *Hydrol. Process.* **15** (2001) 1301–1346.
- [70] DELONG, M.D., THORP, J.H., Significance of instream autotrophs in trophic dynamics of the Upper Mississippi River, *Oecologia* **147** 1 (2005) 76–85.
- [71] FÜREDER, L., et al., Dietary and Stable Isotope ( $\delta^{13}\text{C}$ ,  $\delta^{15}\text{N}$ ) Analyses in Alpine Stream Insects, *Int. Rev. Hydrobiol.* **88** 3–4 (2003) 314–331.
- [72] CLEMENT, J.C.H., PETERSON, R.B., PINAY, G., Isotopic investigation of denitification in a riparian ecosystem in western France, *J. Appl. Ecol.* **40** (2003) 1035–1048.
- [73] PREINER, S., DROZDOWSKI, I., SCHAGERL, M., SCHIEMER, F., HEIN, T., The significance of side-arm connectivity for carbon dynamics of the River Danube, Austria, *Freshw. Biol.* **53** (2008) 238–252.
- [74] TOCKNER, K., PENNETZDORFER, D., REINER, N., SCHIEMER, F., WARD, J.V., Hydrological connectivity, and the exchange of organic matter and nutrients in a dynamic river-floodplain system, *Freshw. Biol.* **41** (1999) 521–535.
- [75] FISCHER, H., WANNER, S.C., PUSCH, M., Bacterial abundance and production in river sediments as related to the biochemical composition of particulate organic matter (POM), *Biochemistry* **61** (2002) 37–55.
- [76] SEITZINGER, S.P., et al., Nitrogen retention in rivers: model development and application to watersheds in the northeastern USA, *Biogeochemistry* **57/58** (2002) 199–237.
- [77] BEHRENDT, H., OPITZ, D., Retention of nutrients in river systems: Dependence on specific runoff and hydraulic load, *Hydrobiologia* **410** (2000) 111–122.
- [78] ALLAN, J.D., *Stream Ecology: Structure and Function of Running Waters*, Kluwer Academic, London (1995) 400.
- [79] FISCHER, H., SACHSE, A., STEINBERG, C.E.W., PUSCH, M., Differential retention and utilization of dissolved organic carbon by bacteria in river sediments, *Limnol. Oceanogr.* **47** (2002) 1702–1711.
- [80] RAYMOND, P. A., BAUER, J.E., Riverine export of aged terrestrial organic matter to the North Atlantic Ocean, *Nature* **409** (2001) 497–500.
- [81] McCLAIN, M.E., et al., Biogeochemical hot spots and hot moments at the interface of terrestrial and aquatic ecosystems, *Ecosystems* **6** 4 (2003) 301–312.
- [82] GREN, I.M., GROTH, K., SYLVEN, M., Economic values of Danube floodplains, *J. Environ. Manage.* **45** (1995) 333–345.

- [83] WARD, J.V., MALARD, F., TOCKNER, K., Landscape ecology: a framework for integrating pattern and process in river corridors, *Landsc. Ecol.* **17** (2002) 35–45.

# PHYSICAL AND HUMAN CONTROLS ON THE CARBON COMPOSITION OF ORGANIC MATTER IN TROPICAL RIVERS: AN INTEGRATED ANALYSIS OF LANDSCAPE PROPERTIES AND RIVER ISOTOPIC COMPOSITION

M.V.R. BALLESTER, R.L. VICTORIA, A.V. KRUSCHE

Centro de Energia Nuclear na Agricultura,  
Universidade de São Paulo,  
Piracicaba, Brazil

M. BERNARDES

Universidade Federal Fluminense,  
Rio de Janeiro, Brazil

C. NEILL, L. DEEGAN

Marine Biological Laboratory,  
Woods Hole, MA,  
USA

J.E. RICHEY

University of Washington,  
Seattle, WA,  
USA

## Abstract

We applied an integrated analysis of landscape properties including soil properties, land cover and riverine isotopic composition. To evaluate physical and human controls on the carbon composition of organic matter in tropical rivers, we applied an integrated analysis of landscape properties including soil properties, land cover and riverine isotopic composition. Our main objective was to establish the relationship between basin attributes and forms, fluxes and composition of dissolved and particulate organic matter in river channels. A physical template was developed as a GIS-based comprehensive tool to support the understanding of the biogeochemistry of the surface waters of two tropical rivers: the Ji-Paraná (Western Amazonia) and the Piracicaba (southeastern of Brazil). For each river we divided the basin into drainage units, organized according to river network morphology and degree of land use impact. Each sector corresponded to a sampling point where river isotopic composition was analysed. River sites and basin characteristics were calculated using datasets compiled as layers in ArcGis Geographical Information System and ERDAS-IMAGINE (Image Processing) software. Each delineated drainage area was individually characterized in terms of topography, soils, river network and land use. Carbon stable isotopic composition of dissolved organic matter (DOM) and particulate organic matter (POM) was determined at several sites along the main tributaries and small streams. The effects of land use on fluvial carbon composition were quantified by a linear regression analysis, relating basin cover and river isotopic composition. The results showed that relatively recent land cover changes have already had an impact on the composition of the riverine DOM and POM, indicating that, as in natural ecosystems, vegetation plays a key role in the composition of riverine organic matter in agricultural ecosystems.

## 1. INTRODUCTION

Environmental problems are growing in significance as the world becomes more aware of the vulnerability of ecosystem goods and services as a function of global change. In this con-



text, concerns over high deforestation rates, habitat fragmentation and biodiversity losses in tropical regions have been increasing in the last decades. On average, 7.3 million hectares per year (or 20 000 ha/d) of forest were lost from 1990 to 2005, the equivalent of 3% of the world's total forested area [1]. Deforestation continues at an alarming rate of about 13 million hectares a year. In Latin America, an example of this process can be seen in Amazonia, one of the most important ecosystems of the planet, containing over 5 million km<sup>2</sup> of forest, the largest contiguous extent of tropical rain forest on earth. While most of the region remains forested, over the past two decades rapid development has led to the destruction of about 700 thousand km<sup>2</sup> of forest in Brazil alone [2]. One of the main causes of deforestation in Amazonia has been the conversion of natural primary forest to pastures for cattle. Slash and burn, the most widely used practice in the conversion of forests to pasture, leads to cation enrichment on surface soils in pastures and secondary forests, derived from inputs from the forest plant biomass to the soil as ash during forest clearing and burning [3].

Understanding the dynamics and consequences of land cover/use changes is recognized as key to responding to this global concern [4]. Land use and land cover play important roles in shaping our environment at global, regional, and local scales [5]. Forest clearing can lead to increases in soil temperature, erosion and modifications in water balance and nutrient availability [6–10]. As a consequence, the transport of sediments, organic matter and associated nutrients to rivers is also altered [6, 11]. In tropical areas, there are only a few studies showing the consequences of land-use/cover changes in river biogeochemistry [6, 11]. The absence of forest canopy shadowing at the pasture allows for extensive growth of naturally occurring *Paspalum* grasses on the margins and even inside stream channels. The resulting increase in organic matter loading promotes higher respiration rates, increasing CO<sub>2</sub> evasion and shifting the oxic conditions observed in forest streams to almost anoxia in pasture ones [6]. The isotopic composition ( $\delta^{13}\text{C}$ ) of both particulate and dissolved organic fractions reflects the predominance of C-3 and C-4 plants as sources of riverine carbon in forest and pasture streams, respectively. Isotopic carbon data is frequently used to discriminate sources of organic matter in rivers, due to the differential <sup>13</sup>C/<sup>12</sup>C values of terrestrial vegetation with different photosynthetic routes (C3, C4 or CAM) and phytoplankton [12]. Pasture streams exported, on an annual basis, almost 20 times more dissolved organic carbon (DOC) than forests. While forested watersheds retain most DOC leach by precipitation during the rainy season, in pasture watersheds net losses of carbon to streams do not occur only in the beginning of the rainy season [13]. Regardless of these results from small stream studies, at the meso-scale level there is still a lack of information on how river biogeochemical composition varies along a gradient of different human disturbance intensities.

To understand how land cover and land use changes are affecting river biogeochemistry, we need to identify landscape drivers, to determine how river biogeochemical signals are generated, maintained and altered by human intervention. Furthermore, our main objective was to identify changes in landscape configuration and composition, key knowledge required to understand how river biogeochemical signals are generated, maintained and altered by human intervention. To evaluate physical and human controls on organic matter carbon composition, we applied an integrated analysis of landscape properties, including topography, soil properties and land use/cover as well as river isotopic composition [5]. A physical template was developed as a GIS-based comprehensive tool to support understanding of the biogeochemistry of the surface waters of two rivers: the Ji-Paraná river in western Amazonia [5, 14] and the Piracicaba river in southeastern Brazil [8]. In this study, we addressed three research questions:

- (1) What is the relationship between basin attributes and surface water chemistry?

- (2) What are the changes in the pathways and fluxes of organic matter, nutrients, and associated elements along river as a function of human activities and land use/cover change?
- (3) Does this relationship exhibit seasonal differences?

To answer these questions we established the relationships between large scale basin factors and river biogeochemical composition in two tropical meso-scale rivers and two small streams. These factors were categorized as those directly influenced by human activities and those constrained by physical factors, such that the biogeochemical consequences for water chemistry associated with anthropogenic perturbations can be separated from the background of natural environmental variability.

## 2. STUDY AREAS

The Piracicaba river basin drains an area of 12 thousand km<sup>2</sup> of a highly urbanized landscape, encompassing more than 3 million inhabitants (Fig. 1a). Soils are mostly ultisol and oxisol, acidic, and with low fertility and cation content. The main land cover/use at headwaters is pasture. From the middle sectors to the lower reach the land cover is dominated by sugar cane. Moreover, the main land cover in the basin is C4 grass vegetation, encompassing 62% to 80% of the drainage area. Land cover of the small stream basins of this area is mainly sugar cane, with a smaller portion of pasture. C4 grass vegetation covers 83% to 91% of the basin (Fig. 1b).

The Ji-Paraná River Basin, located in the State of Rondônia, Western Amazonia (Fig. 1c), drains an area of 75 000 km<sup>2</sup>. This basin is characterized by extensive development in the central part, and slight alteration in the lower 400 km before the confluence with the Madeira River, near the city of Calama. From its headwaters to its middle sectors, the river is highly impacted, with a predominance of pastures. The lower reach reverts to relatively pristine natu-

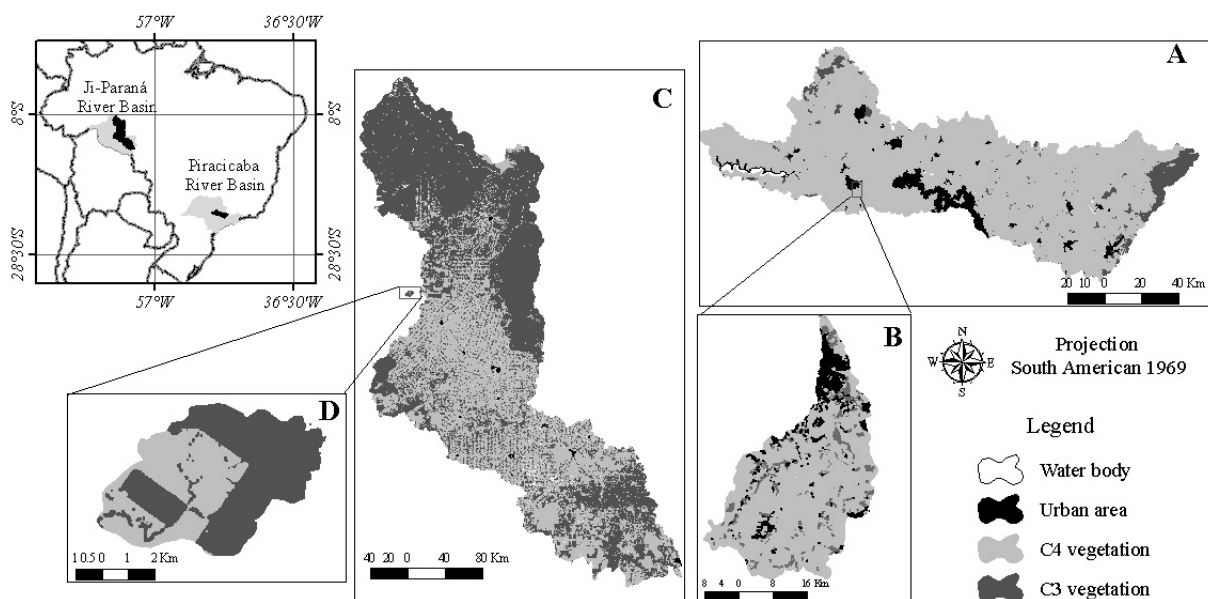

FIG. 1. Study areas: a) Land use/land cover maps of (A) Piracicaba River Basin, (B) small stream basin, São Paulo State, Southwest Brazil, (C) Ji-Paraná River Basin and (D) small stream basin, Rondônia State, Western Amazonia.

ral forest. Another important characteristic of these units is that they integrate a variety of environmental processes and human impacts on the landscape. The headwaters have an initial low degree of land use impact, about 10% of the drainage area is covered by C4 grasses. Along its course, the Ji-Paraná receives the contributions of five other main tributaries and as the river increases in order, it drains areas with medium, high and up to very high degrees of land use/cover changes, and the area covered by C4 vegetation increases to 73% of the landscape. Downstream, the Ji-Paraná reverts into a landscape dominated by forest cover and low land use impact. The micro scale study was developed in one stream draining pure pasture, another pure forest and the mixture of both of them (Fig. 1d).

### 3. METHODS

Both river basins were divided into drainage units organized according to river network morphology and the degree of land use impact (Table 1, Fig. 1). Each sector corresponds to a sampling point where river biogeochemistry and organic matter isotopic composition was determined as described below [14–15]. In these two basins, we also sampled two micro basins to evaluate the effect of land use change at the smaller scale. A flowchart summarizing the methodological procedures and analysis is presented in Fig. 2. Briefly, at each site, 50–100 L of water was collected from the river in the middle of the channel at 60% of the total depth using an electric pump. The water sample was sieved (0.63 mm) at the field in order to separate the coarse particulate organic matter (CPOM) fraction, which was immediately preserved with HgCl<sub>2</sub>. The fine particulate organic matter (FPOM) fraction (<0.63 mm and >0.1 mm) and ultra filtered dissolved organic matter (UDOM) fractions (<0.1 mm and >1000 daltons) were isolated in the laboratory with a Millipore tangential flow ultra filtration system (model Pelli-con-2; Millipore, Billerica, Massachusetts, USA), using membrane cartridges having a nominal 0.1 mm pore size (model Durapore VVPP; Millipore) and a 1000-daltons molecular weight nominal cut off (model PLAC; Millipore), respectively. After filtration, the retentate was dried to constant weight in an oven at 60°C. Isotope measurements were performed with a Finnigan Delta-Plus mass spectrometer fitted with double inlet and double collector systems. Results are expressed in  $\delta^{13}\text{C}$  relative to PDB isotopic standard, defined as Eq. 1.

TABLE 1. PHYSICAL (TOPOGRAPHY AND RIVER NETWORK) AND ANTHROPOGENIC (LAND USE) CHARACTERISTICS OF TWO TROPICAL RIVER AND SMALL STREAM BASINS (BRAZIL)

River Basin	River reach	Slope (degree)	River network order	density (km/km <sup>2</sup> )	Human introduced C4 grass area (%)
Piracicaba	Headwaters	5.8–10	3rd–4th	2.1–2.6	67–68
	Central	1.3–5.4	5th–6th	1.9–2.3	72–75
	Lower	2.6–4.7	6th	1.1–1.7	75–80
Stream			1st–5th	1.0	83–91
Ji-Paraná	Headwaters	0.6–1.1	3rd–5th	0.4–0.7	8–11
	Central	0.2–1.4	5th–6th	0.6–0.9	32–73
	Lower	0.2–0.6	7th	0.7–0.8	4–11
Streams			1st–3rd		0–100

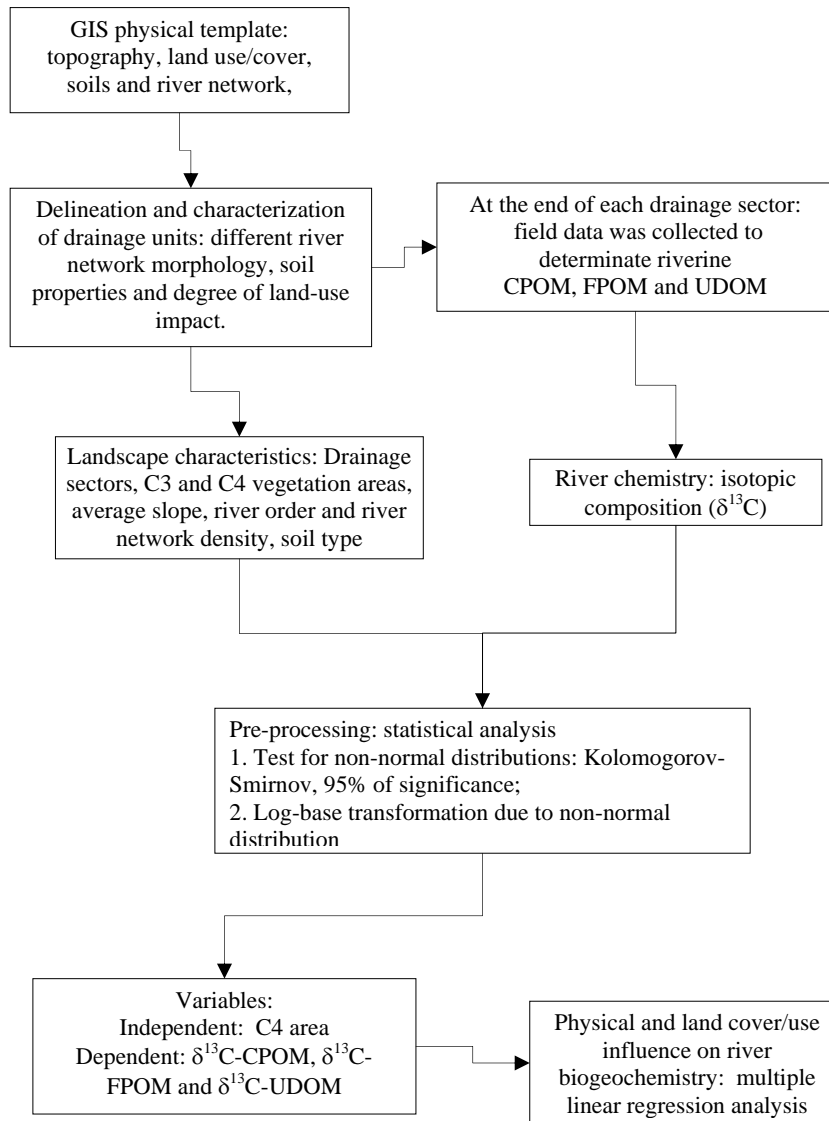

FIG. 2. Flowchart of methodological procedures and analysis. GIS — Geographic Information System; CPOM — coarse particulate organic matter; FPOM — fine particulate organic matter; UDOM — ultra fine dissolved organic matter.

$$\delta^{13}\text{C}, \text{‰} = (R_{\text{sample}} / R_{\text{std}}) - 1 \times 1000 \quad (1)$$

Where  $R_{\text{sample}}$  and  $R_{\text{std}}$  are the  $^{13}\text{C}:^{12}\text{C}$  of the sample and standard, respectively. Samples were analysed at least in duplicate with a maximum difference of 0.2‰ between replicates.

River sites and basin characteristics were derived from datasets compiled as layers in the ArcGis 9.2 Geographical Information System (GIS) and ERDAS-IMAGINE 8.7 (Image Processing) software. To delineate sub-basin boundaries of the sampling sites, the Digital Elevation Model (DEM) and the river network were derived from Brazilian Institute of Geography and Statistics (IBGE, [www.ibge.gov.br](http://www.ibge.gov.br)) maps. Latitude and longitude coordinates of the sampling sites were recorded in the field using a Global Positioning System unit (Garmin, GPS48 Model), and then imported into ArcGis, where they were matched to the nearest point in the DEM. Watershed boundaries were delineated using ArcGIS hydrological extension. Each delineated drainage area was individually characterized in terms of topography (average altitude

and slope), soils, river network, land cover and land use. River order was calculated using the Strahler method. Land cover and land use maps were derived from a digital classification of Landsat images, acquired from the Brazilian National Institute for Space Research Tropical ([www.inpe.br](http://www.inpe.br)) and the Rain Forest Information Center (TRFIC) at Michigan State University as radiometrically and geometrically corrected images. Details on processing and accuracy assessment can be found elsewhere [5]. The effects of land cover on carbon composition of the rivers were evaluated by comparing the variability of these components along the sub-basins using a linear regression analysis.

#### 4. RESULTS AND DISCUSSION

Suspended particulate organic material (POM) has been identified as an important component of fluvial ecosystems for five reasons:

- (1) A fair amount of carbon is transported in particulate form [16];
- (2) POM provides food for numerous organisms;
- (3) POM links upstream to downstream reaches [17];
- (4) The amount of POM influences water chemical composition [18];
- (5) POM integrates natural and anthropogenic processes in the basin [19].

A comparison of fluvial particulate organic matter stable carbon isotopic composition ( $\delta^{13}\text{C}$ -POM) with that of the vegetation and soils in draining basins can be used to identify carbon sources [20–24]. Large isotopic differences between the  $\delta^{13}\text{C}$  values of C3 and C4 plants permits recognition of the relative contribution of each type of vegetation to fluvial organic materials, particularly in areas where the landscape is covered by a mixture of these plants.

On pristine and large tropical rivers, where C3 vegetation is well established in the landscape and POM has had enough time to acquire the isotopic signal of the basin vegetation, waters of rivers draining forested basins have  $\delta^{13}\text{C}$ -POM values resembling this type of vegetation, ranging from about  $-30$  to  $-27\text{‰}$ . In rivers draining savannas (C4) and mixed savannas/forests regions  $\delta^{13}\text{C}$ -POM values are around  $-28$  to  $-19\text{‰}$ . In areas where original vegetation has been recently ( $\sim 30$  to 100 years ago) replaced by C4 plants, such as sugar cane and cattle pasture, much less information is available on the origin of particulate organic carbon.

In the last 70 to 80 years, as a result of several economic cycles, almost 95% of the original vegetation of the Piracicaba River Basin was replaced by coffee, citrus, pasture and sugar cane. Today, a significant area is covered with C4 plants, encompassing 76% of the basin area, while C3 plants occupy about 18%. Sugar cane plantations comprise 32% of the basin area and pastures 44%. Isotopic composition of the soil carbon clearly shows that sugar cane C4 material has been incorporated in this basin pool. Only 12 years of sugar cane cultivation were enough to change the soil organic matter  $\delta^{13}\text{C}$  from its original value of  $-25.1$  to  $-23.0\text{‰}$ . After 50 years of cultivation, this value was  $-20.2\text{‰}$  and about 40% of the soil C3 forest carbon has been replaced by sugar cane C4 carbon [25]. At the micro scale basin, land cover changes were even more intense. The area covered by C4 vegetation comprised 92.5% of the drainage basin, with the landscape dominated by sugar cane (61% of the total area) and pasture (22%).



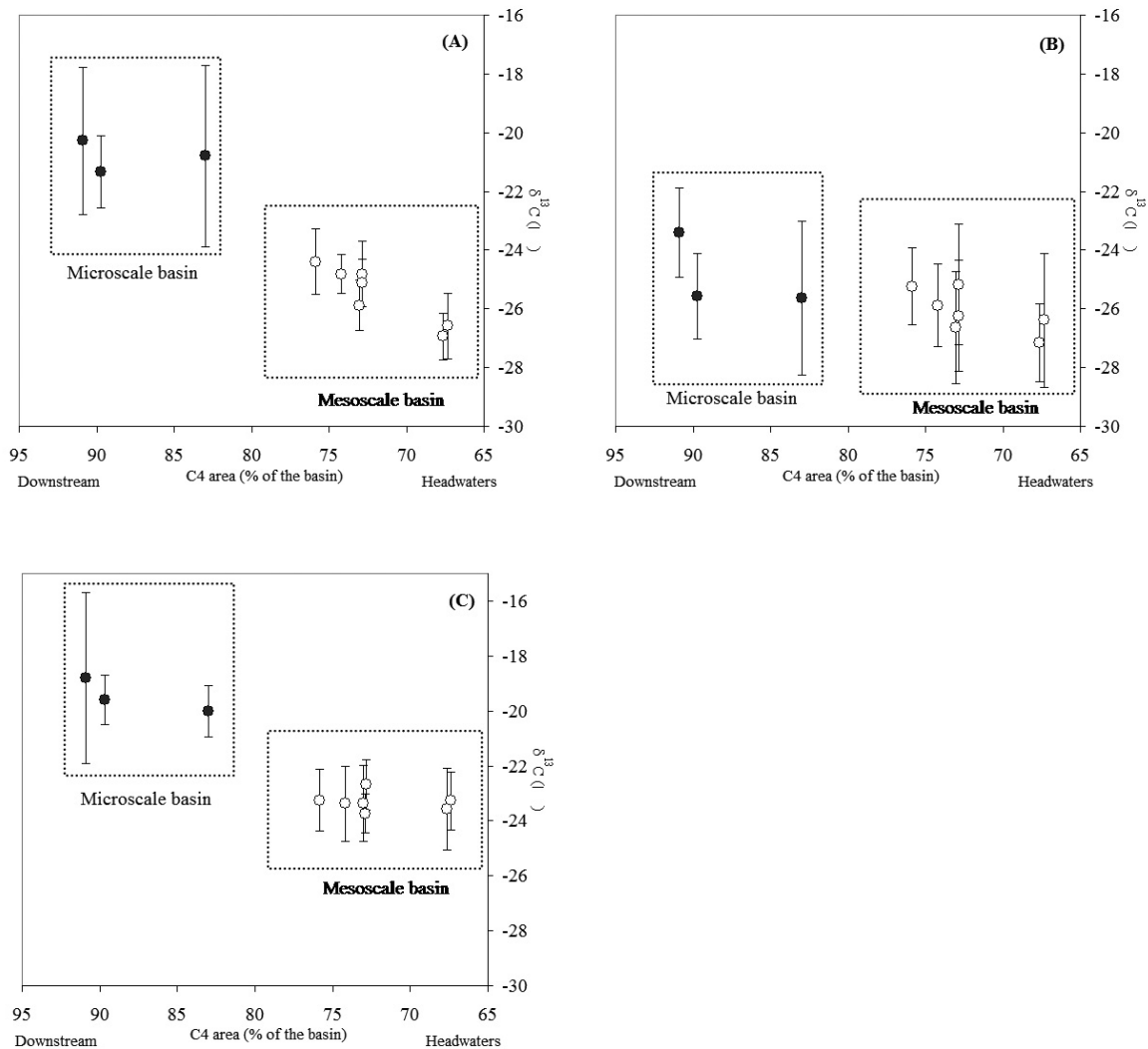

FIG. 3. Fluvial carbon isotopic composition ( $\delta^{13}\text{C}$ ) of the (A) fine POM, (B) coarse POM and (C) UDOM of the Piracicaba River and main tributaries.

In the Piracicaba River Basin, 45% of the fluvial transport of organic carbon was in dissolved form, while 8% was transported as CPOM and 47% as FPOM. Despite the fact that there was a large variability in the  $\delta^{13}\text{C}$  of FPOM and UDOM fractions in river waters [26], we found that the cumulative area of the basin covered by C4 plants was a good predictor of average  $\delta^{13}\text{C}$ -POM and  $\delta^{13}\text{C}$ -UDOM, and statistically significant for all fractions ( $p < 0.01$ ;  $r^2 = 0.92$ ;  $r^2 = 0.50$ ;  $r^2 = 0.86$  for fine, coarse and UDOM fractions, respectively).

At the headwaters, where there is a mixture of C3 and C4 plants, both main tributaries (the Atibaia and Jaguari rivers) showed a similar pattern and average  $\delta^{13}\text{C}$  of all organic fractions were not statistically different (Fig. 3). The  $\delta^{13}\text{C}$  of the fine fraction ranged from  $-31.9$  to  $-22.7\text{‰}$ , with an average of  $-25.7 \pm 1.32\text{‰}$  ( $n = 75$ ). The  $\delta^{13}\text{C}$  of coarse POM also exhibited large variability, from  $-29.0$  to  $-23.2\text{‰}$ , with an average of  $-25.8 \pm 1.23\text{‰}$  ( $n = 78$ ). The heaviest  $\delta^{13}\text{C}$  values were found in the UDOM fraction, ranging from  $-25.3$  to  $-21.8\text{‰}$  and an average of  $-23.4 \pm 0.94\text{‰}$  ( $n = 32$ ). Lighter  $\delta^{13}\text{C}$  values observed in fine and coarse fractions in the headwaters of the Piracicaba River Basin were associated with phytoplankton growth. During the low water period, upstream river channels usually became greenish [26] and  $\delta^{13}\text{C}$ -POM



values are in the range of  $-32$  to  $-29\text{‰}$ . These values are similar to the average  $\delta^{13}\text{C}$  of pure phytoplankton samples collected in the basin ( $-31.0 \pm 4.7\text{‰}$ ), suggesting that in situ primary production could be an important source of light carbon to river POM during the dry season [26].

Downstream, as the main stem enters the subsequent sectors, where C4 sugar cane dominates, an isotopic enrichment was found, and  $\delta^{13}\text{C}$  values always became heavier in all fractions (Fig. 3). In this area,  $\delta^{13}\text{C}$ -POM variability was smaller than in the two tributaries. The fine fraction ranged from  $-28.1$  to  $-23.1\text{‰}$ , with an average of  $-25.5 \pm 1.37\text{‰}$  ( $n = 32$ ). In the coarse fraction these values were heavier, ranging from  $-26.1$  to  $-20.8\text{‰}$ , with an average  $\delta^{13}\text{C}$  of  $-24.6 \pm 0.96\text{‰}$  ( $n = 31$ ), and also statistically different from the averages of tributary coarse fractions ( $P < 0.01$ ). On average, the UDOM fraction had a  $\delta^{13}\text{C}$  of  $-23.3 \pm 1.3\text{‰}$  ( $n = 71$ ), ranging from  $-26.5$  to  $-20.1\text{‰}$ . At the micro-scale level, the same pattern was found (Fig. 3), an isotopic enrichment as a function of the areal extent of C4 vegetation covering the drainage basin. On average,  $\delta^{13}\text{C}$  values were always heavier in this area, ranging from  $-20.3$  to  $-21.3\text{‰}$  in the FPOM fraction from  $-23.4$  to  $-25.6\text{‰}$  in the CPOM fraction and from  $-18.8$  to  $-20.0\text{‰}$  in the UDOM fraction.

In Rondônia, soils under forest cover reflect the values of C3 vegetation, with a low variability in  $\delta^{13}\text{C}$  isotopic composition. The  $\delta^{13}\text{C}$  values of surface soil layers typically fall in a narrow range of  $-27.0$  to  $-28.5\text{‰}$ , consistent with other measurements in tropical forests [27]. In this area, the introduction of C4 grasses results in a soil isotopic enrichment, and  $\delta^{13}\text{C}$  values in general increased with pasture age. After 7 to 9 years of pastures, surface layer soil average  $\delta^{13}\text{C}$  values were  $-22.4 \pm 1.6\text{‰}$ , reaching  $-19.4 \pm 1.1\text{‰}$  after 20 years of pasture introduction [27]. After 81 years of pasture cultivation the values in the 0–10 cm layer were very close to the grass  $\delta^{13}\text{C}$  value of  $-14.3\text{‰}$  [28].

These results demonstrate that in agricultural systems, as in natural ecosystems, not only in-channel processes (such as primary production) are important sources of carbon to river channels, but basin vegetation cover also plays a major role in the composition of riverine particulate organic matter [21–23, 29, 30]. In this area, land cover and use in the last century have affected the composition of riverine particulate and dissolved organic matter. However, the large spatial and temporal variability in carbon stable isotopic composition indicates that different types of POM are entering the Piracicaba River Basin at different times. Moreover, GIS-based assessments of vegetation distributions and dynamics should prove a powerful tool to understanding river POM composition drivers, and any attempt to fully comprehend the fluvial dynamics of organic matter in tropical regions must account for the high variability generated by differences in channel and basin processes.

The Ji-Paraná is a sub-basin of the Madeira River, where most fluvial transport of organic carbon was in the particulate form, 55.1% as FPOM and 43.3% as CPOM. Only 1.6% was transported in the dissolved organic fraction. In areas where the dominant land cover was forest, fluvial  $\delta^{13}\text{C}$  values of fine and coarse fractions were similar to those of the Madeira River [30], ranging from  $-27.8$  to  $-26.1\text{‰}$

At the headwaters, where natural C3 tropical forest vegetation still dominates the landscape, both main tributaries (Comemoração and Pimenta Bueno rivers) showed a similar pattern of low variability in  $\delta^{13}\text{C}$  values and no statistical differences were observed among sampling sites (Fig. 4). The  $\delta^{13}\text{C}$  values of fine fraction ranged from  $-29.0$  to  $-26.3\text{‰}$ , with an average of

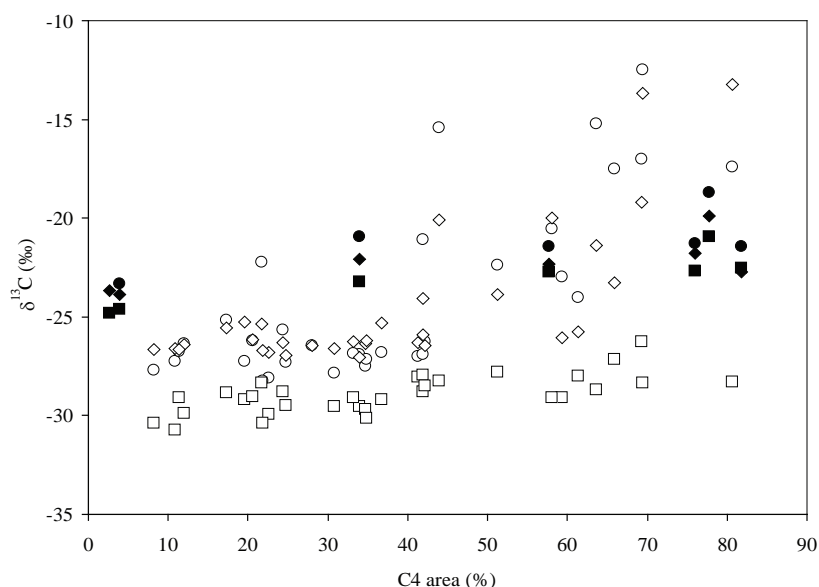

FIG. 4. Fluvial carbon isotopic composition ( $\delta^{13}\text{C}$ ) of FPOM (lozenge), CPOM (circle) and UDOM (square) of the Ji-Paraná River and main tributaries (clear symbols) and a small stream (filled symbols) in western Amazonia.

$-28.0 \pm 0.2\text{‰}$  ( $n = 20$ ). In the coarse fraction,  $\delta^{13}\text{C}$  values were lighter, ranging from  $-32.5$  to  $-28.4\text{‰}$  with an average of  $29.2 \pm 0.8\text{‰}$  ( $n = 24$ ). The UDOM fraction exhibited the heaviest  $\delta^{13}\text{C}$  values and the larger variability found in this area, ranging from  $-28.4$  to  $-21.7\text{‰}$ , with an average of  $-26.9 \pm 1.5\text{‰}$  ( $n = 16$ ).

Several studies conducted during the late 1980s in the Amazon have shown that basin vegetation cover is one of the main controls of  $\delta^{13}\text{C}$  in riverine organic matter [20, 21], although soil texture may also have some influence [29]. In Amazonian agricultural ecosystems, where the original C3 forest has been replaced by C4 plants, C4-derived organic matter quickly becomes incorporated into surface soil layers [27, 28]. In the Ji-Paraná River Basin, widespread deforestation has been primarily related to road development and official settlement projects, developed by the Brazilian Federal Government [31–33]. Large areas of previously untouched rainforest have undergone rapid change since the early 1970s due to extensive immigration and colonization, with strong impacts on the spatial distribution of deforestation, resulting in more intensive land-use and land cover changes in the central part of the river basin, where most of the colonization projects were established and road opening was concentrated [5]. In this area,  $\delta^{13}\text{C}$  values of the fine fraction span from  $-29.1$  to  $-17.0\text{‰}$  with an average of  $-26.9 \pm 2.4\text{‰}$  ( $n = 38$ ). On average, the coarse fraction was heavier ( $-28.9 \pm 0.9\text{‰}$ ,  $n = 40$ ) and less variable, with  $\delta^{13}\text{C}$  values ranging from  $-30.8$  to  $-26.3\text{‰}$ . The UDOM fraction was lighter, with an average  $\delta^{13}\text{C}$  value of  $-25.8 \pm 2.3\text{‰}$  ( $n = 30$ ). The maximum value was  $-28.2$  and the minimum  $-19.2\text{‰}$  (Fig. 4).

The main characteristic of the final part of the Ji-Paraná river basin is the reversion of the land cover pattern observed in the preceding areas; forest becomes the main land cover and 64% of the basin landscape is covered by C3 moist tropical forest and savanna vegetation. This change in land cover affects all fractions of particulate and dissolved organic material in transit in the river, resulting in a lighter composition of the  $\delta^{13}\text{C}$  isotopic composition of river organic

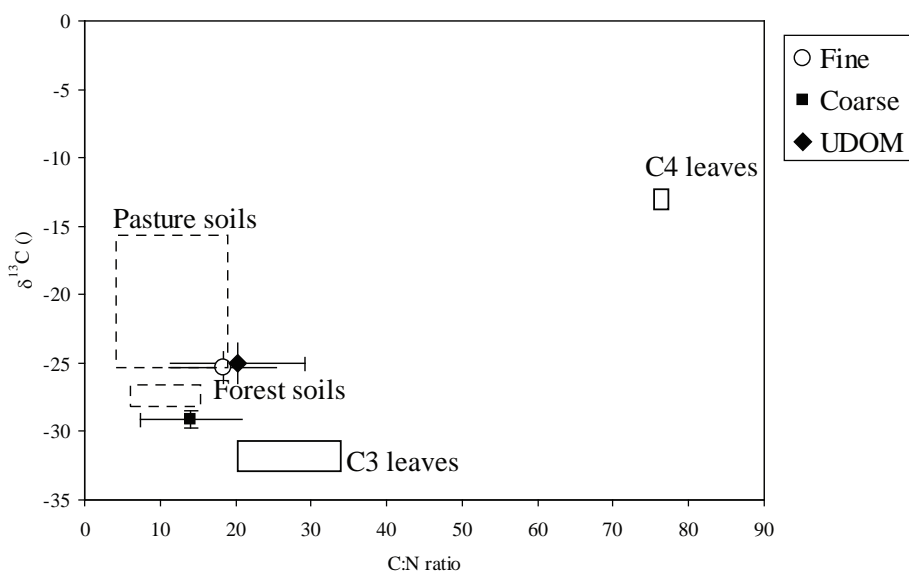

FIG. 5. C:N ratio and carbon isotopic composition ( $\delta^{13}\text{C}$ ) of terrestrial sources of particulate and dissolved organic material draining into Ji-Paraná River channels [34].

matter. The  $\delta^{13}\text{C}$  values of the fine fraction ranged from  $-26.8$  to  $-30.5\text{‰}$ , with an average of  $-28.3 \pm 1.2\text{‰}$  ( $n = 14$ ). Lighter values were found in the coarse fraction, which showed an average  $\delta^{13}\text{C}$  of  $-29.6 \pm 1.4\text{‰}$  ( $n = 18$ ), spanning values from  $-35.1$  to  $-28.5\text{‰}$ . The UDOM was heavier and presented smaller variability in data, ranging from  $-28.3$  to  $-25.3\text{‰}$  with an average value of  $-27.2 \pm 0.9\text{‰}$  ( $n = 10$ ).

Most of the pasture areas were established between the late 1980s and early 1990s. Today about 50% of the central part of the basin is covered by 20 year old pastures. These recent changes in land cover and land use in the Ji-Paraná River Basin have already impacted soil composition [27] and an isotopic enrichment of fluvial organic carbon was expected as the river drains areas largely covered by C4 pasture (Fig. 4). In fact, while the  $\delta^{13}\text{C}$  values of the coarse fraction resemble mainly forest soils, the fine and UDOM fractions have values closer to those of pasture soils.

The same pattern was found in an extensive survey of sub-basins with different combinations of land cover and soil type. The characteristics of the organic matter size fractions carried into the channels from the basins' landscape, showed that river carbon isotopic composition was altered in 38 sub-basins (Fig. 5). The area covered by C4 plants in each basin explained 62% of the variability observed in the  $\delta^{13}\text{C}$  of the fine fraction, 46% of the coarse fraction and 55% of the UDOM.

At the micro scale level, we found that forest conversion into pasture results in an extensive in-channel growth of the C4 grass *Paspalum* and higher dissolved organic carbon concentration and respiratory rates (Fig. 6) in pasture streams. At this scale, incorporation of the C4-derived organic matter into riverine particulate and dissolved organic matter was more evident (Fig. 5) mainly for two reasons. First, we were able to sample areas draining pure pasture and pure forest and then a series of mixtures of them. Second, all pastures were established in the same year, therefore pasture age was the same and isotopic enrichment more constant.

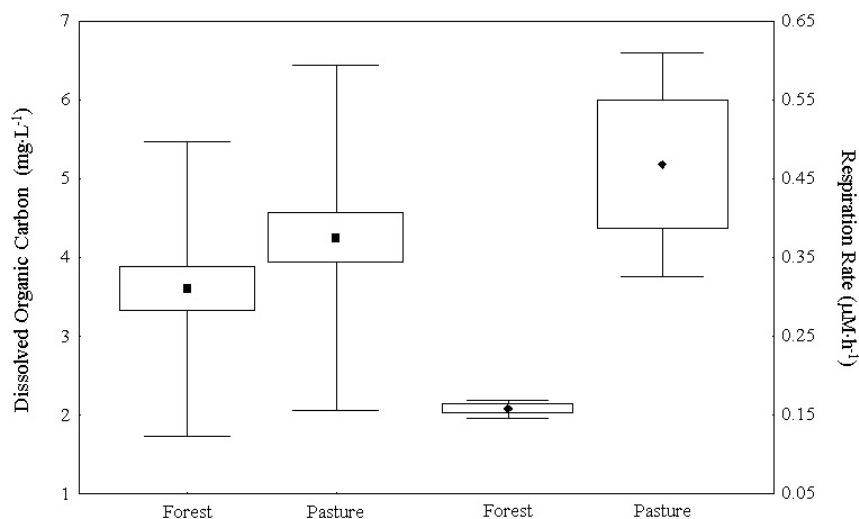

FIG. 6. Dissolved organic carbon concentration and respiration rate in small stream channels covered by forest and pasture in western Amazônia.

Further evidence of the effects of change in land cover on carbon cycling in these streams is the isotopic composition of dissolved inorganic carbon. The conversion of carbon dioxide into organic matter removes  $^{12}\text{C}$ , resulting in  $^{13}\text{C}$  enrichment of the residual dissolved inorganic carbon (DIC). In turn, when the organic matter is oxidized there is a release of  $^{12}\text{C}$ -enriched carbon back in the inorganic reservoir [35]. Moreover, in river channels where aerobic decomposition is the dominant pathway of organic matter decay,  $\delta^{13}\text{C}$  values of DIC became lighter as DIC concentration increased due to the excess of dissolved  $\text{CO}_2$  originating from respiration processes. In pasture areas, as oxygen is depleted and methanogenesis becomes the dominant decomposition pathway,  $\delta^{13}\text{C}$  DIC values become heavier. Our results show that streams draining forest areas have average  $\delta^{13}\text{C}$  DIC values of  $-12.0 \pm 4.2$  ‰ ( $n = 8$ ). When forest was replaced by pasture, this value increased to  $-2.3 \pm 1.8$  ‰ ( $n = 9$ ), clearly showing the effects on carbon cycling.

#### 4.1. Management implications

Naturally scarce and with a spatial heterogenic distribution, fresh water is a strategic resource that by the end of the next decade will play a key role in economic development [36]. However, the effects of human activities on river structure (for example, habitat and biodiversity) and functioning (such as nutrient cycling) still remain largely unreported in several parts of the world. Moreover, for an effective protection of ecosystems and the goods and services they provide to humans, society will need to respond with improved water management and more effective policies [36]. In this scenario, understanding the carbon cycle is a key aspect to accessing the implications of land use changes in the watershed in river habitat and biodiversity, water quality and availability. Understanding the dynamic of carbon isotopic composition of organic matter fractions in rivers can provide solid quantitative information relating to changes in the landscape induced by human intervention and the potential effects on the fluvial ecosystem to support decision making.

## 5. CONCLUSIONS

Our results clearly indicate the importance of assessing watershed characteristics to fully comprehend their role as geographic sources of bio-active elements to the rivers. In general, land use in the basin has a strong influence on river chemistry and at this scale was a good predictor of river carbon composition. Overall our results indicated that at the Piracicaba River, sugar cane plantations caused a higher impact in river water than on pasture. At the Ji-Paraná River, the substitution of forest by pasture is the main cause of changes in river biogeochemistry. Based on observed pasture establishment patterns, in terms of the consequences for river chemistry, little change should be expected in the headwaters due to limitations of soil properties. If areas located in lower reaches of the river were deforested and converted into pasture, we would expect changes in river water composition similar to those observed in the central part of the basin. These types of studies are important because they address to what extent land cover/use changes have altered the  $\delta^{13}\text{C}$  composition of organic matter, providing information on the rates of organic carbon transfer from the basin to the river that is difficult to obtain in relatively unaltered drainage basins.

## ACKNOWLEDGEMENTS

This publication is a result of an international collaboration between the Centro de Energia Nuclear na Agricultura — USP, the University of Washington, and the Marine Biological Laboratory as part of the Large Scale Biosphere-Atmosphere Experiment in Amazonia (LBA). Research was sponsored by the Fundação de Amparo à Pesquisa do Estado de São Paulo (FAPESP, Processes numbers 99/01159–4 and 03/13172–2) from Brazil and by the National Aeronautics and Space Administration (NASA) from the USA (LBA-ECO, ND–09, ND–03 and CD–06).

## REFERENCES

- [1] FOOD AND AGRICULTURE ORGANIZATION, State 64 of the World's Forests 2007, Part 1: Progress Towards Sustainable Forest Management (2007) 64–71.
- [2] INSTITUTO NACIONAL DE PESQUISAS ESPACIAIS, Monitoring of the Brazilian Amazon forest by satellite 1997–2007, National Institute for Space Research, São José dos Campos, SP, Brazil (2007).
- [3] MARKEWITZ, D., DAVIDSON, E.A., FIGUEIREDO, R.O., VICTORIA, R.L., KRUSCHE, A.V., Control of cation concentrations in stream waters by surface soil processes in an Amazonian watershed, *Nature* **410** (2001) 802–805.
- [4] GEIST, H.L., LAMBIN, E.F., What drives tropical deforestation?, LUCS Report Series Number 4, IGBP, Ciaco, Belgium (2001)116.
- [5] BALLESTER, M.V.R., et al., A Remote Sensing/GIS-based physical template to understand the biogeochemistry of the Ji-Paraná River Basin (Western Amazônia), *Remote Sens. Environ.* **87** 4 (2003) 429–445.
- [6] NEILL, C., et al., Deforestation alters hydraulic and biogeochemical characteristics of small lowland Amazonian streams, *Hydrol. Process.* **20** (2006) 2563–2580.

- [7] VICTORIA, D.C., et al., Water balance for the Ji-Paraná river basin, western Amazon, using a simple method through Geographical Information Systems and Remote Sensing, *Earth Interactions* **11** 5 (2007) 1–22.
- [8] BALLESTER, M.V.R., et al., Effects of increasing organic matter loading on the dissolved O<sub>2</sub>, free CO<sub>2</sub> and respiration rates in the Piracicaba river basin, Brazil, *Water Resour. Res.* **33** 9 (1999) 2119–2129.
- [9] OMETTO, J.P., MARTINELLI, L.A., BALLESTER, M.V.R., Effects of land use on water chemistry and macroinvertebrates in two streams of the Piracicaba river basin, south-east Brazil, *Freshw. Biol.* **44** (2000) 327–337.
- [10] CERRI, C.E.P., et al., GIS Erosion Risk Assessment of the Piracicaba River Basin in Southeastern Brazil, *Mapping Sci. Remote Sens.* **38** 3 (2001) 157–171.
- [11] THOMAS, S., Influences of land use and stream size on particulate and dissolved materials in a small Amazonian stream network, *Biogeochemistry* **68** (2004) 135–151.
- [12] WEST, J.B., BOWEN, G.J., CERLING, T.E., EHLERINGER, J.R., Stable isotopes as one of nature’s ecological recorders, *Trends Ecol. Evol.* **21** (2006) 408–414.
- [13] GOUVEIA-NETO, S.C., Concentrações e balanços de carbono orgânico dissolvido em duas bacias do Estado de Rondônia: uma comparação entre floresta e pastagem, Master Thesis, Centro de Energia Nuclear na Agricultura, USP (2006).
- [14] KRUSCHE, A.V., As mudanças no uso da terra e a biogeoquímica dos corpos d’água na Amazônia, *Acta Amazônica* **35** 2 (2005) 209–217.
- [15] VICTORIA, R.L., et al., “Effects of land use changes in the biogeochemistry of Ji-Paraná river, a meso-scale river in the state of Rondônia, southern Amazon”, Proc. Large Scale Biosphere-Atmosphere Experiment in Amazonia First Scientific Conference, Belém, Pará, Brazil, 25–28 June (2000).
- [16] MEYBECK, M., Carbon, nitrogen and phosphorus transport by world rivers, *Am. J. Sci.* **282** (1982) 401–450.
- [17] CUSHING, C.E., MINSHALL, G.W., NEWBOLD, J.D., Transport dynamics of fine particulate organic matter in two Idaho streams, *Limnol. Oceanogr.* **38** (1993) 1101–1115.
- [18] SUNG, W., Some observations on surface partitioning of Cd, Cu and Zn in estuaries, *Environ. Sci. Technol.* **29** (1995) 1303–1312.
- [19] HEDGES, J.I., et al., Origins and processing of organic matter in the Amazon River as indicated by carbohydrates and amino acids, *Limnol. Oceanogr.* **39** (1994) 743–761.
- [20] HEDGES, J.I., Organic carbon-14 in the Amazon River System, *Science* **231** (1986) 1129–1131.
- [21] QUAY, P.D., et al., Carbon cycling in the Amazon River: Implications for the <sup>13</sup>C compositions of particulate and solutes, *Limnol. Oceanogr.* **37** (1992) 857–871.
- [22] BIRD, M.I., GIRESSE, P., CHIVAS, A.R. The effect of forest and savanna vegetation on the carbon-isotope composition of sediments from the Sanaga River, Cameroon, *Limnol. Oceanogr.* **39** (1994) 1845–1854.



- [23] BIRD, M.I., GIRESSE, P., NGOS, S., A seasonal cycle in the carbon-isotope composition of organic carbon in the Sanag River, Cameroon, *Limnol. Oceanogr.* **43** (1998) 143–146.
- [24] FRANCE-LANORD C., DERRY, L.A.,  $^{13}\text{C}$  of organic-carbon in the Bengal fan source evolution and transport of C3 and C4 plant carbon to marine-sediments, *Geochim. Cosmochim. Acta* **58** (1994) 4809–4814.
- [25] VITORELLO, V.A., CERRI, C.C., ANDREUX, F., FELLER, C., VICTORIA, R.L., Organic matter and natural carbon-13 distribution in forested and cultivated oxisols, *Soil Sci. Soc. Am. J.* **53** (1989) 773–778.
- [26] MARTINELLI, L.A., Land cover changes and  $\delta^{13}\text{C}$  composition of riverine particulate organic matter in the Piracicaba river basin (southeast region of Brazil), *Limnol. Oceanogr.* **44** 7 (1999) 1826–1833.
- [27] NEILL, C., et al., Soil Carbon and nitrogen stocks following forest clearing for pasture in the southwestern Brazilian Amazon, *Ecol. Appl.* **7** 4 (1997) 1216–1225.
- [28] MORAES, J.F.L., VOLKOFF, DE B., CERRI, C.C., BEMOUX, M., Soil properties under Amazon forest and changes due to pasture installation in Rondonia, Brazil, *Geoderma* **70** (1996) 63–81.
- [29] MARIOTTI, A., GADEL, F., GIRESSE, P., KINGA-MOUZEO, Carbon isotope composition and geochemistry of particulate organic matter in the Congo River (Central Africa): Application to the study of Quaternary sediments off the mouth of the river, *Chem. Geol.* **86** (1991) 345–357.
- [30] HEDGES, J.I., et al., Compositions and fluxes of particulate organic material in the Amazon River, *Limnol. Oceanogr.* **31** (1986) 717–738.
- [31] DALE, V.H., O'NEILL, R.V., PEDLOWSKI, M., SOUTHWORTH, F., Causes and effects of land-use change in central Rondônia, Brazil, *Photogram. Eng. Remote Sensing* **59** 6 (1993) 997–105.
- [32] DALE, V.H., O'NEILL, R.V., SOUTHWORTH, F., PEDLOWSKI, M., Modelling effects of land management in the Brazilian Amazonian settlement of Rondônia, *Conservation Biology* **8** 1 (1994) 196–206.
- [33] PEDLOWSKI, M., DALE, V.H., MATRICARDI, E., DA SILVA FILHO, E.P., Patterns and impacts of deforestation in Rondônia, Brazil, *Landscape and Urban Planning* **38** (1997) 149–157.
- [34] BERNARDES, M., et al., Organic matter composition of rivers of the Ji-Paraná basin (southwest Amazon basin) as a function of land use changes, *Ecol. Appl.* **14** (2004) S263–S279.
- [35] HOEF, J., *Stable isotope geochemistry*, 5th revised and updated edition. Springer, Berlin, Germany (2004) 244.
- [36] UNITED NATIONS EDUCATIONAL, SCIENTIFIC AND CULTURAL ORGANIZATION, *The United Nations World Water Development Report 3. Water in a Changing World*, UNESCO, Paris, France, ISBN 978–92–3–104109–9 (2009).

# **GROUNDWATER INPUTS TO RIVERS: HYDROLOGICAL, BIOGEOCHEMICAL AND ECOLOGICAL EFFECTS INFERRED BY ENVIRONMENTAL ISOTOPES**

L. STELLATO

Centre for Isotopic Research on Cultural and Environmental heritage (CIRCE),  
Seconda Università degli Studi di Napoli,  
Caserta, Italy

B.D. NEWMAN

Isotope Hydrology Section,  
International Atomic Energy Agency,  
Vienna, Austria

## **Abstract**

In an effort to improve river management, numerous studies over the past two decades have supported the concept that river water and groundwater need to be considered together, as part of a hydrologic continuum. In particular, studies of the interface between surface water and groundwater (the hyporheic zone) have seen the tight collaboration of catchment hydrologists and stream ecologists in order to elucidate processes affecting stream functioning. Groundwater and surface waters interact at different spatial and temporal scales depending on system hydrology and geomorphology, which in turn influence nutrient cycling and in-stream ecology in relation to climatic, geologic, biotic and anthropogenic factors. In this paper, groundwater inputs to rivers are explored from two different and complementary perspectives: the hydrogeological, describing the generally acknowledged mechanisms of streamflow generation and the main factors controlling stream–aquifer interactions, and the ecological, describing the processes occurring at the hyporheic and the riparian zones and their possible effects on stream functioning and on nutrient cycling, also taking into consideration the impact of human activities. Groundwater inflows to rivers can be important controls on hot moment/hot spot type biogeochemical behaviors. A description of the common methods used to assess these processes is provided emphasizing tracer methods (including physical, chemical and isotopic). In particular, naturally occurring isotopes are useful tools to identify stream discharge components, biogeochemical processes involved in nutrient cycling (such as N and P dynamics), nutrient sources and transport to rivers, and subsurface storage zones and residence times of hyporheic water. Several studies which have employed isotope techniques to clarify the processes occurring when groundwater enters the river, are reported in this chapter, with a view to highlighting both the advantages and limitations of these tracer methods. In short, isotope techniques can be a powerful tool for understanding the importance and nature of groundwater–surface water interactions on nutrient cycling in streams and rivers. The main recommendations for their use are to keep well in mind the appropriate spatial and temporal scales of the chosen technique and to use them in conjunction with other methodologies in order to better test working hypotheses and conceptual models. A multi-scale approach, from channel to catchment scale, is also recommended for the identification of the role that groundwater plays in nutrient cycling and sustaining river and floodplain habitats.

## **1. INTRODUCTION**

The need for conjunctive assessment of surface water and groundwater for effective management of water resources is frequently emphasized by the scientific community [1, 2]. However, surface water and groundwater have often been considered as if they were independent resources in the framework of water resources management policies. The 2007 Theis Conference focused on the conjunctive management of groundwater and surface water, stressing the need

to apply science to policy; hence, the concept of their interdependency is becoming widely accepted and incorporated in water management policies and practices [3, 4]. When surface water and groundwater are hydraulically connected, degradation of one resource can affect the quality of the other; for example, polluted groundwater entering a stream can affect surface water quality if no degradation mechanisms occur to mitigate this impact. The main purpose of studying surface water–groundwater interactions is to develop conceptual and predictive models describing hydrological and biogeochemical processes occurring at different spatial and temporal scales so that improved management practices can be identified and implemented.

Currently, a major concern of water resources managers is understanding the fate and dynamics of nutrients in riverine ecosystems because of their potential impacts on both river and human health (as outlined in European Council Directive 91/676/EEC [11]). An up-to-date review about nutrient dynamics in streams can be found in Ref. [5]. Nutrients are released within a catchment mainly by agricultural practices and urban/industrial activities, in addition to natural sources such as soils and organic matter. They can be discharged into surface water bodies by means of nutrient rich groundwater inflows [6]. Such inflows to rivers can be important controls in hot moment/hot spot type biogeochemical behaviors [7]. In particular, nitrogen (N) and phosphorus (P) in rivers can stimulate, for example, phytoplankton growth causing algal blooms (eutrophication) and, indirectly, oxygen depletion at the bottom of the water column. These changes can alter community structure, which in turn can disrupt the functioning of the aquatic ecosystem [8]. Groundwater has been recognized as having a major role as a control of stream ecosystem health [9, 10], primarily sustaining the baseflow of streams. The mechanisms occurring when groundwater enters a stream are complex and not very well understood, though a great effort has been spent by watershed hydrologists and stream ecologists to clarify them [12–14].

According to the river continuum concept (RCC; [15]), a river is a hydrologic continuum within which, from its source area to its outflow, a longitudinal succession of gradually succeeding ecosystems takes place exchanging water, solutes and energy with the surrounding terrestrial ecosystems: along the course of a river, geomorphological, hydrodynamical and physicochemical parameters change, consequently influencing the structure and function of biological communities [16]. Generally, low order mountain streams have a heterotrophic metabolism (whole system respiration exceeds gross primary production) sustained by inputs from the terrestrial environment (such as detritus from riparian vegetation), with a low rate of photosynthesis due to shading, and within which shredder and collector communities dominate over the grazers [17]. Medium order streams (4–6th) have a higher photosynthetic rate because of the reduction of shaded surface, and the metabolism changes to a mainly autotrophic one sustained by the aquatic primary producers (such as algae); the grazers dominate together with the collectors, while the abundance of shredders decreases. In large rivers (order > 6th), even if shading becomes negligible, photosynthesis is inhibited by water turbidity and the system is again heterotrophic; the dominant macroinvertebrate community is represented by collectors who are sustained by particulate organic matter produced in upstream tracts. In the RCC, hydrology, hydrogeology, geomorphology, riparian and stream ecology information converge and provide a unifying vision of the complexity of riverine systems, though it is far from the description of a real system where great variability of features related to specific environmental conditions can be found (including wetlands, meanders, arid climate and karst watersheds). Fluvial ecosystem stability, which is the ‘capability of a natural system to apply self-regulating mechanisms so as to return to a steady-state after an outside disturbance’ [18], depends mainly on the biologic diversity which regulates the energetic inputs and outputs of a system [19, 20]. It is clear that, since river ecosystems are subjected to huge physical variations due mainly to

variable flow regimes, a higher stability is maintained if the biotic component is highly diversified; hence, it is able to adapt itself to changing conditions.

After being discharged into a stream, via overland and/or subsurface water pathways, nutrients and organic matter are subject to cycling and downstream transport. The coupling of cycling and transport is represented conceptually by a spiral (nutrient spiralling). Spiral diameters are related to the recycling rate, and the distance between coils is related to the retention capacity of a system [21–23]. High retention coupled with a high recycling rate gives rise to great system stability [24]. The availability of nutrients and organic matter to lotic communities thus depends on advective transport and retention. Transport can be either along longitudinal or vertical and/or lateral directions, depending on local hydraulic conditions, including interactions between surface and subsurface water, and on the stream flow regime [1]. Many studies have reported the importance of groundwater as a major source of nutrient and organic matter load to riverine environments [17, 25–27]. Moreover, the scientific community has invested considerable effort to try and comprehend retention processes and their controls, as these have long been recognized to be very important to nutrient uptake, transformation and transport in stream ecosystems [28, 30]. Retention is controlled by both physical and biotic mechanisms, which lower solute transport velocities in a way that cannot be predicted by advective transport rates alone [31]. In-stream features such as debris dams, slow flow areas (pools) and bed roughness are identified as major physical controls of retention [32, 34], while uptake of dissolved constituents and consumption of organic matter by lotic flora and fauna are considered major biotic controls [20, 35]. It is now well understood [12, 28, 29, 36] that the interface between surface and subsurface waters, which is known as the hyporheic zone, is a centre of intense biochemical activity where retention mechanisms are enhanced owing to the fact that surface and subsurface waters exchange water, solutes and fauna bi-directionally [37–39].

Given the high activity within the hyporheic zone, this component of aquatic ecosystems requires in-depth study to elucidate nutrient dynamics in riverine ecosystems. Specifically, the detection and quantification of groundwater inputs to rivers as well as the investigation of groundwater flow paths within streambed and riparian sediments and understanding of hyporheic exchange mechanisms are all critical elements that will aid in the understanding and management of nutrients in rivers. The identification of critical mechanisms which can lower, and sometimes improve, the quality of a water resource, requires an assessment of processes occurring at different spatial and temporal scales, since the interactions between surface and subsurface waters take place from catchment, to reach, to subreach scales and can occur within temporal frames of days, seasons and/or decades.

This paper describes the factors controlling groundwater–surface water exchanges at different scales, from stream flow generation processes to hyporheic exchange mechanisms, and the effects of groundwater inputs on nutrient cycling and stream ecosystems. Special attention will be placed on the tracer approach, which has been widely used to address different problems such as the identification of stream flow components in storm flow and baseflow conditions [40–42], groundwater flow paths [43], nutrient uptake, transport and biodegradation in riverine ecosystems [44, 45], hyporheic zone extent and exchange rates [28, 31] and the retention of solutes [36, 46], among others. Exhaustive reviews of the application of tracers in surface and subsurface hydrology can be found in [47, 49].

Stable and radioactive isotopes have been extensively used to identify water residence times, components of stream discharge [50, 51], nutrient biodegradation processes [27], and to quan-

tify groundwater inflows to rivers [52, 53], resulting in the development of very useful tools in the comprehension of effluent river ecosystems. Among radioactive tracers,  $^{222}\text{Rn}$  (radon), a naturally occurring noble gas, is particularly useful for detecting groundwater discharge to streams because of its different concentrations in surface water and groundwater [42, 53–57]. It is also useful for characterizing hyporheic exchange [58, 59]. Two case studies are reported in Section 5 of this volume, in which the hypotheses that  $^{222}\text{Rn}$  is a suitable tracer to detect groundwater inputs to rivers and to estimate water residence time within riverbed sediments are tested.

The intention of the authors is to give an overview of techniques (especially isotope techniques) helpful in elucidating groundwater inputs to rivers and hyporheic surface–subsurface water exchange. The basic concepts and processes controlling surface water–groundwater interactions are discussed in order to define the spatial and temporal variations of the exchanges, which must be understood to properly assess nutrient cycling in complex systems such as rivers and streams.

## **2. FUNCTIONAL ROLE OF GROUNDWATER IN FLUVIAL ECOSYSTEMS**

Surface water and groundwater, as discussed in the previous section, interact at different scales, either in space and/or in time. In every landscape, distinctive features can be found in relation to geology, climate, geomorphology and the human management of a catchment that affect surface water–groundwater interactions [1, 60]. Streams may receive their water from different flow pathways in a drainage basin: via groundwater, overland flow, interflow, or direct precipitation [61–63]. The types of source areas will strongly affect the types and quantities of nutrients delivered to a river. For example, in the Mississippi River basin, Alexander et al. [64] found that total nitrogen was higher with respect to phosphorous when sources were from corn/soybean production areas, while phosphorous was higher than nitrogen when sources were from pasture/rangelands. However, simply knowing about sources is often insufficient because hydrological flowpaths will strongly affect delivery times from source areas to a river, influence nutrient concentrations and chemical forms, and control whether nutrients are added as pulses or as relatively continuous inputs.

Many studies carried out in humid and temperate regions demonstrate that groundwater is the major contributor to stream flow, either during baseflow or storm flow conditions [40, 41, 65–67]. In arid and semi-arid regions, groundwater inputs can also be important, although they may be more temporally and spatially variable than in humid and temperate regions (see Newman et al. 2006 for conceptual models). In this paper, the primary focus is on groundwater inputs to streams, although overland flow and interflow (for example, lateral movement of water that occurs in the upper part of the unsaturated zone, or vadose zone, that directly enters a stream channel or other body of water without having occurred first as surface runoff) should not be overlooked as important influences on nutrient cycling in rivers both from point source and non-point source perspectives (see discussion in Refs [68, 69]. For example, even in arid/semi-arid regions, interflow contributions may be important (see Refs [70, 71]. With regard to groundwater influences, Hynes [25] pointed out that groundwater intimately influences stream ecology when surface and subsurface water are hydraulically connected. The main functional role of groundwater is sustaining the baseflow of many running water systems, establishing proper conditions for lotic faunal and floral communities by supplying nutrients, water [8, 35], dissolved organic and inorganic carbon [17, 72], and moderating stream temperatures, which



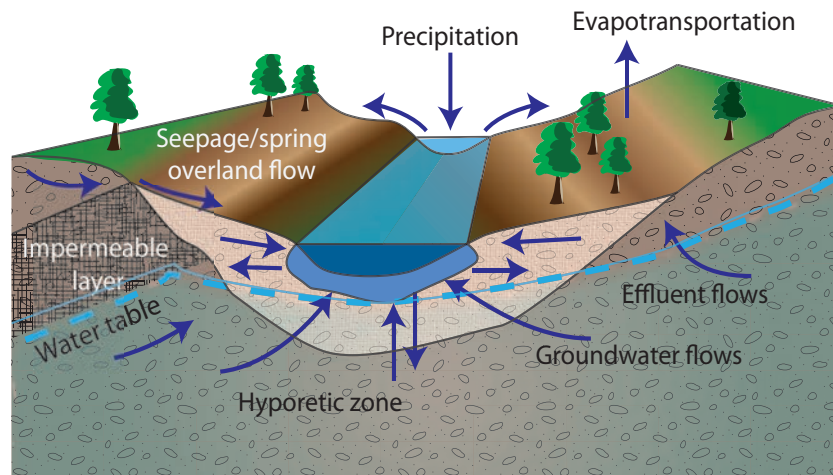

FIG. 1. Schematic diagram showing losing/gaining stream conditions as well as other hydrologic flow paths in rivers (adapted from [75]).

in turn may affect the rates of many biogeochemical processes [73, 74]. In addition, groundwaters can also alter dissolved ion concentrations in rivers which can affect stream ecology and nutrient cycling. The patchy and localized nature of groundwater inputs is one of the factors influencing the high degree of spatial heterogeneity that characterizes stream ecosystems [16, 76] and leads to nutrient cycling hot spots. Sear et al. [75] identified several hydrological, geomorphological, geochemical and ecological features typical of groundwater dominated rivers (including stability of flow and thermal regimes, high water clarity, low sediment load, reduced drainage network, dense beds of macrophytes, rich and abundant faunal community), recognizing that local changes may affect the extent and magnitude of ‘groundwater dominance’, which frequently represents only a portion of a river. Another way that groundwater inputs (and surface water inputs) can affect nutrient cycling is through their influence on river flow rates. O’Connor and Hondzo [77] recently showed that flow rates affect denitrification in sediments by shifting the depth of dissolved oxygen penetration. Under high flow rates, nitrate degradation was inhibited because the conditions for denitrification (anoxia, see Ref. [78]) were shifted to deeper parts of the sediment profile. Thus, where, when, and how groundwater inputs arrive at a river or stream can affect nutrient cycling in different ways.

Once groundwater enters the river channel (gaining stream, see Fig. 1) as discharge from regional or local flow systems (sensu [79]), it mixes with surface water; further downstream, if the river stage is higher than the adjacent water table, it may infiltrate below the streambed sediments, recharging the local groundwater system (losing stream, see Fig. 1).

Segments of water inflow and outflow may alternate along the course of a surface water body spatially, because of changes in channel morphology and geologic substrate, and temporally because of changes in hydrologic regime and the level of the groundwater table, thus influencing the functioning of the river ecosystem. Moreover, stream water may locally or temporarily infiltrate below a streambed and within stream banks mixing with subsurface water in the hyporheic zone (Fig. 2). This peculiar biotope (sensu [80]) acts as a refuge and habitat for benthic organisms [81], and many types of biogeochemical transformations occur here that may directly affect river chemistry [16]. The hyporheic zone has been defined in various ways (see Ref. [46]), but what is clear is that it represents a relatively fine scale region (hyporheic flowpaths are generally considered to only be from 1 cm to 1 m long) where groundwater–surface water interactions lead to enhanced biogeochemical activity [12, 39]. Because groundwater inputs and discharge vary with space and time, the size of hyporheic zones varies as well.



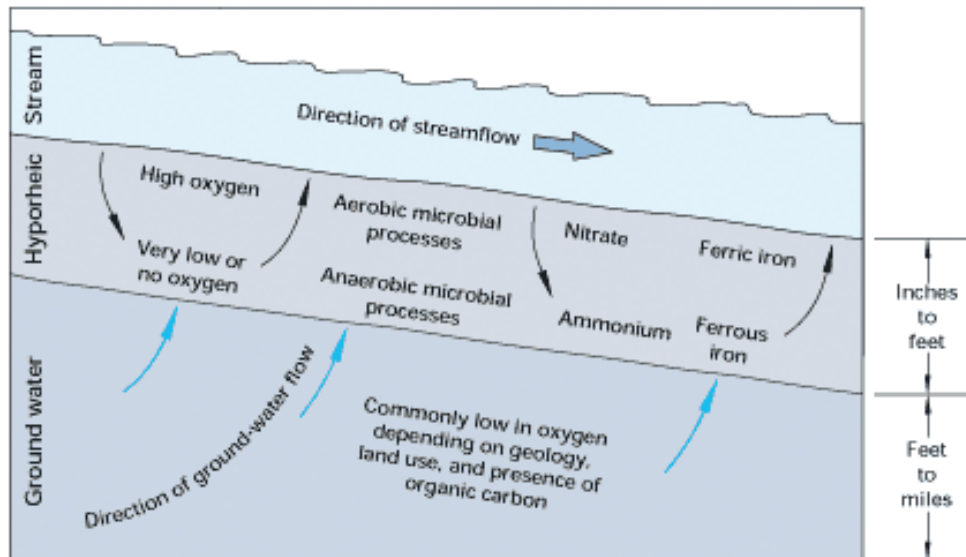

FIG 2. Cross-section of a stream highlighting the scale of hyporheic and groundwater zones as well as common biogeochemical processes and reactions [1].

Dahm et al. [82], define three surface compartments as organizational features of surface water–groundwater interactions within a floodplain (riparian, parafluvial and surface zones), and state that “linking hydrological and biogeochemical dynamics within and between the groundwaters of these three compartments or subsystems is a vital research and management goal”. Thus, understanding nutrient cycling is not just a problem of measuring nutrient concentrations. A better understanding of the problem is obtained when biogeochemical and hydrological methods are integrated. Such an approach is beneficial because it can greatly aid in selecting the most optimal preventative or mitigative measures, which can substantially offset any additional characterization costs. For example, Alexander et al. [64] used an integrated approach in the Mississippi River basin, and their results suggest that targeted mitigations on selected parts of the basin would be the most efficient approach for reducing nutrient delivery to the Gulf of Mexico. They suggest that managers should focus on mitigation practices that reduce the sources and the quantity of nutrients near the largest rivers or near small streams with short water travel times, as opposed to the other streams and rivers in the basin. Another important and sometimes overlooked question that the integrated approach can help address is how long it will take before improvements are observed if an action is made to address a particular nutrient problem. An understanding of hydrology can be used to determine whether benefits will be observed immediately, within a year or so, or whether it may take a few decades, which is an important consideration for monitoring, stakeholder buy-in, and policy making purposes.

### 3. GROUNDWATER INPUTS TO RIVERS: METHODS AND APPROACHES

The assessment of surface–subsurface water connectivity requires information about the characteristics of surface water and groundwater systems of a catchment, and their interactions, gathered through preliminary collection and interpretation of existing datasets. Such preliminary assessment can be useful in characterizing the physical system (including rainfall, evaporation, topography, surface drainage, geology, geomorphology, land use) and its spatial and

temporal variability (such as time series records of water levels, flow and quality parameters) in order to identify knowledge gaps and critical points to effectively address further investigations [4]. Different approaches and techniques have been developed and applied to elucidate groundwater–surface water interactions influencing nutrient dynamics in lotic ecosystems [1].

In this section, an overview is provided on approaches and methods allowing for the detection and quantification of groundwater inputs to surface water, the tracing of water flow paths within riparian and streambed sediments and the understanding of hyporheic zone exchange mechanisms. Water flowpaths and hyporheic exchange mechanisms are major controls on advective transport and retention of solutes in rivers [82], and thus are key mechanisms regulating the abundance and cycling of nutrients in riverine environments.

Particular attention is given to the tracer approach, especially the application of environmental isotopes, which have been established as useful and sometimes unique tools for the management of connected water resources [48, 83, 84].

A useful way to deal with the description of methodologies applied to understanding surface water–groundwater interactions and their impact on river nutrient cycles, is to discuss them in relation to their suitability to characterize specific processes and mechanisms occurring at different scales, identifying the spatial and temporal windows of detection typical of each application [85]. Such a conceptual framework helps to build a coherent picture of processes which take place at different scales in a functional way, providing investigators and managers with a common way of understanding the complexity of these transitory systems where very often, if not always, long and short term dynamics as well as large and small scale processes overlap [82].

On this basis, different approaches and methods are presented in this section according to their suitability to elucidate large scale and small scale interaction processes and mechanisms controlling nutrient dynamics in river ecosystems. Large scale interactions occur at the catchment scale and/or at the floodplain scale, while small scale interactions occur at the reach or sub-reach scale and deal with processes taking place within the streambed and bank sediments where surface and subsurface waters mix. Some of the described tools are suitable for both large and local scale investigations.

### **3.1. Large scale investigations**

At the basin/catchment scale, the assessment of nature and degree of interaction between surface water and groundwater systems is carried out by means of a wide range of tools, from desktop analyses to field surveys. These include hydrogeological mapping, hydrographic analysis, hydrometrics, geophysics and remote sensing, water budget analysis, modelling and the use of environmental tracers. Hereafter, the main characteristics of each method are summarized, referring to the subdivision adopted by Brodie et al. [4] in their thorough review, though examples will only be provided for the tracer techniques.

**Hydrogeological mapping** helps to define the geological or geomorphological features that can control groundwater flow, and to provide the general hydrogeological setting (for example, identifying flow systems); it is of fundamental importance when interactions between surface water and groundwater systems have to be characterized [79, 86, 87]. According to Dahm et al. [82], the “geomorphic perspective appears to offer a fruitful approach for characterizing

surface water–groundwater interactions for large drainages, and can be useful for predicting the extent and location of such interfaces”.

**Hydrographic methods** are based on the analysis of time series records of water levels, water flows or other hydraulic properties in order to quantify quick flow and base flow components of a stream hydrograph [61, 88, 89]. Quick flow is defined as the direct response of a stream hydrograph to rainfall events, including overland flow (runoff), interflow and direct precipitation on the river channel, while baseflow is the long term discharge of the river, sustaining the flow between rainfall events and assumed to be mainly groundwater from a shallow unconfined aquifer, even though other natural storage zones can sustain the baseflow of a stream (such as connected lakes, wetlands, glaciers, bank storage). These methods (baseflow separation, frequency and recession analysis) are valid only when effluent conditions (such as gaining stream reaches) occur and provide information on the temporal variability of groundwater discharge.

**Water budget** ( $Q_{gw} = Q_{down} - Q_{up} - \Sigma q_{in} + \Sigma q_{out}$ ) is a widespread approach applied to quantify volumes of groundwater discharge,  $Q_{gw}$ , to or from a river by means of stream flow measurements at specific points,  $Q_{down}$  and  $Q_{up}$ . Water balance is estimated for each stream segment taking into account inflows,  $\Sigma q_{in}$ , (such as tributaries, direct rainfall, runoff) and outflows,  $\Sigma q_{out}$ , (including diversions, evaporative losses, withdrawals). The  $Q_{gw}$  can be either positive, indicating an effluent stream reach, or negative, indicating an influent stream reach. Though it is very simple conceptually, it may be very difficult to apply because of the large uncertainties of stream flow measurements and the estimation of all input and output components.

**Hydrometric analysis** is based on the Darcy’s law, which describes the water flow in a porous medium as directly dependent on the cross-sectional area of the medium through which the flow occurs, the hydraulic head difference between two points, vertically or horizontally spaced, and the hydraulic conductivity of the medium [90]. By means of hydraulic head measurements in wells, piezometers or nests of piezometers drilled in a flood plain, river banks or a riverbed, it is possible to reconstruct groundwater flow nets and identify effluent or influent conditions in a basin. This technique has limitations in terms of estimating discharges quantitatively, because of the large magnitude of variation and the distribution of hydraulic conductivities in the flood plain and fluvial sediments and the difficulty in quantifying how these properties vary with time and water content [9, 82].

Investigations based on geophysical surveys and remote sensing (such as airborne electromagnetic (AEM), radiometrics, seismic waves, electrical charge or satellite imagery) may reveal spatial and temporal variations in water quality (such as salinity), saline groundwater discharge to streams, aquifer texture, geological and geomorphological features controlling stream–aquifer connectivity (see Ref. [91]).

**Modelling** (analytical and numerical) has been largely applied to characterize surface–sub-surface water interactions. The mathematical representation of hydrological processes is of widespread use and it is very helpful in predicting system changes following changes of key parameters and/or boundary conditions by means of a simplified representation of the processes taking place. The main drawback of the modelling approach is oversimplification, made through assumptions which, if incorrect, can result in a poor representation of the complexities of natural systems. Often, determining the representativeness of a given assumption is difficult. Moreover, the integration of processes occurring at different scales, and the interpolation of temporally variable measurements, and non-unique analytical solutions can become additional

sources of error [4]. Models have been developed, for example, to predict groundwater response to precipitation [92, 93], to simulate impacts of management scenarios on groundwater recharge and total water yields [94], and to investigate the effects of groundwater pumping on stream flow [95].

**Hydrochemistry** analysis of stream water and groundwater samples for environmental tracers mainly aims to identify hot spots and trends of groundwater discharge to streams.

**Environmental tracers** are natural or anthropogenic dissolved compounds or isotopes that are widely distributed in the near surface environment of the Earth such that variations in their abundances can be used to determine pathways and time scales of water flow through a catchment [1, 96]. Tracer methods have been widely applied to assess groundwater–surface water exchanges in order to track water and solute movements, estimate their residence times and study the mixing processes of two or more reservoirs. Conservative tracers, which do not react with the surrounding environment, are used to infer information about water pathways and quantify flows, while non-conservative tracers, which interact with solids or are transformed during the transport, can provide information about water residence times and chemical or biological reaction rates occurring in the saturated zone.

Useful environmental tracers are:

- Field parameters, like electrical conductivity and pH;
- Hydrochemical tracers, both natural (major anions and cations) and industrial (such as CFCs);
- Stable isotopes, like oxygen ( $^{18}\text{O}$ ) and hydrogen ( $^2\text{H}$ ), of the water molecule;
- Radioactive isotopes, like tritium ( $^3\text{H}$ ) and radon ( $^{222}\text{Rn}$ ).

In the following paragraphs, one for each of the above listed tracer categories, several applications of environmental tracers will be discussed. For additional information, the reader is referred to cited references and to other specific handbooks (such as Ref. [47]) for a description of sampling and analytical techniques. The schematization adopted in the following sections has a descriptive purpose, since most reported studies often use a combination of tracers and complementary approaches. An exemplifying case study is reported in section 5 of this volume on the combined use of tracer techniques ( $^{222}\text{Rn}$ , stable isotopes, major ions) and hydrogeologic and hydrometric investigations to assess the extent and magnitude of surface water–groundwater interaction in an alluvial plain.

**Field parameters:** During a field survey, parameters such as pH, alkalinity, redox potential (Eh) and electrical conductivity (EC) are commonly measured and can provide precious preliminary information about the temporal and spatial variability of a system, helping in the choice of sampling location and frequency. Diurnal changes in dissolved oxygen and temperature measured continuously in several lowland streams in New Zealand helped to classify them according to photosynthetic productivity, respiration and reaeration [97]. During base-flow conditions, Lambs [98] used EC to detect inputs of phreatic water in the Garonne river in France; Choi et al. [99] did the same using pH measurements. Continuous measurement of these parameters in key sites can provide useful information about the temporal variability of surface–subsurface water interactions.

**Hydrochemical tracers:** Major cation and anion concentrations in surface and subsurface waters depend mainly on rainfall input amounts, weathering and water–rock interactions, which take place after rainfall has entered the terrestrial hydrological cycle, land cover/land use and aquatic processes. Dissolved compounds undergo physical and (bio)chemical reactions once they reach and move along water flow paths in the saturated zone (such as acid–base controlled reactions, oxy-reduction, sorption, dissolution, precipitation), changing the geochemistry of groundwater from recharge up to discharge areas [100, 101]. As a consequence, groundwater and surface water ion concentrations can be significantly different and under these conditions, and hydrochemical tracers can be useful tools to detect groundwater discharge to surface water bodies. Also, other chemical compounds, such as dissolved gases and industrial or anthropogenic introduced chemicals have also been effectively used in connectivity studies.

A big advantage of using chemical compounds as tracers of hydrological processes is the relatively easy sampling and treatment, as well as the low cost of chemical analyses. Most of these chemical analyses are routinely performed in many analytical laboratories.

Several studies have used chemical compounds in simple mixing models (also known as End Member Mixing Analysis, EMMA) to quantify the amounts of the different components of stream water (groundwater vs upstream river water contributions) during baseflow or storm flow conditions [102–104]. Two component (EMMA type) mixing models are used to estimate the fractions of different water sources or components based on the following equations:

$$Q_1 + Q_2 = Q_s \quad (1)$$

$$C_s Q_s = C_1 Q_1 + C_2 Q_2 \quad (2)$$

from which can be obtained:

$$Q_1/Q_s = (C_s - C_2)/(C_1 - C_2) \quad (3)$$

where  $Q$  is the discharge of a component (groundwater or runoff) [ $L^3/T$ ];  $C$  is the concentration of the tracer [units of concentration], and the subscripts refer to stream water,  $s$ , and the two components, 1 and 2 (end-members). Models with more than two components can also be used and generally, for a mixing of  $n$  sources,  $(n - 1)$  tracers are required.

Genereux and Pringle [105] used the slightly non-conservative nature of sodium ( $Na^+$ ) with respect to chloride ( $Cl^-$ ) to quantify the proportions of solute poor local runoff and solute rich geothermal groundwater in stream water at different sites in the catchment and their spatial variability in a lowland tropical rainforest (Costa Rica). In the same basin, Genereux [106] found that chloride ( $Cl^-$ ) was the best tracer to predict interbasin groundwater transfer, compared to  $^{18}O$  (see Stable isotopes paragraph below), mainly because intra-site variability of  $Cl^-$  was small relative to the large  $Cl^-$  difference between end-members. Eshelmann et al. [107] applied a chemical hydrograph separation technique using chloride to separate old/new water contributions to storm flow in a Mid-Atlantic coastal plain catchment, concluding that storm flow is primarily composed of old water (75% during a storm) as saturation overland flow. Calcium and sulphate [108] and lithium [66] were effectively used in two and three end-member mixing analyses to separate hydrograph components during storm flow in two humid catchments.



To be effectively applied, EMMA requires a significant difference in tracer concentration between end-members. Generally, the greater the difference between concentrations, the greater the sensitivity and the lower the uncertainty of the EMMA approach [109, 110]. In addition, end-member concentrations must be relatively constant in both space and time over the period of interest.

Kirchner et al. [111], comparing the  $\text{Cl}^-$  signatures of rainfall and runoff through time, were able to estimate how long catchments retain a chemical memory of rain that has fallen, quantifying the travel time distribution of rainfall to a stream.

Dissolved carbon dioxide ( $\text{CO}_2$ ) has been used to determine the temporal and spatial variability of groundwater interaction with surface waters in two Cretaceous Chalk catchments (Berkshire, UK) helping to detect groundwater inputs, even though it was less effective in the quantification of fluxes, because of photosynthetic and respirative processes occurring in the sediments and in the water column [112].

Despite their synthetic nature, chlorofluorocarbons (CFCs) deserve a mention as excellent tracers and an effective dating tool of young waters (50 year time scale). In large river basins, where the travel time from recharge to discharge areas is greater than 10 years, CFCs have proven to be valuable tracers of groundwater inflow to rivers [57]. References [113, 114] provided extensive reviews about the use of these compounds in hydrology.

Chemical compounds, such as inorganic nitrogen (ammonium, nitrate and nitrite), dissolved organic carbon (DOC) and soluble reactive phosphorous (SRP), have been largely used to study the influences of groundwater inputs on riverine ecosystem functioning [20, 26, 35, 115].

**Stable isotopes:** Isotopes are atoms of the same element (same atomic number,  $Z = \text{protons}$ ) but with different mass numbers ( $A = \text{number of neutrons} + \text{protons}$ ). They are stable because their nucleuses do not undergo radioactive decay. The different atomic masses may influence compound (isotopomer) behaviour during chemical reactions or phase changes, causing a variation in the isotopic composition of products and reactants; this process, known as isotopic fractionation, can be due, for example, to the differential binding energies of isotopes in different compounds [83]. Light isotope molecules react faster than heavy isotope molecules because their mass difference is mirrored by higher vibrational frequencies [83]. A convenient way to report isotopic signatures of compounds is to report their isotopic ratio (ratio of the rare isotope with respect to the abundant isotope in a compound) to that of an internationally recognized reference material according to the general relation (delta notation):  $\delta(\text{‰}) = [(R_{\text{sa}}/R_{\text{std}}) - 1] \times 1000$ , where  $R$  is the isotopic ratio and the subscripts, sa and std refer to the sample and the reference material. The delta notation has been adopted to account for the typically small isotopic variations which can result from fractionation, and thanks to the resolution of isotopic ratio mass spectrometric (IRMS) techniques, delta values can be estimated to a few per mill or less [116].

Catchment scale interactions between surface and subsurface water have been effectively studied by means of stable isotopes to track water origin and pathways, and mixing and residence times in a drainage basin. Groundwater residence times can affect stream water quality, because short residence times often result in lower concentrations of organic and inorganic constituents in groundwater entering a stream, whereas longer residence times allow for more chemical reactions to occur, often resulting in higher concentrations of chemical constituents of groundwater inputs to a stream. Oxygen and hydrogen isotopes ( $^{18}\text{O}$  and  $^2\text{H}$ ) have been fre-



quently employed in hydrological studies, since they are part of the water molecule ( $^1\text{H}_2^{16}\text{O}$ ,  $^1\text{H}_2^{18}\text{O}$ ,  $^1\text{H}^2\text{H}^{16}\text{O}$  being the most abundant isotopomers). Some of the advantages of the use of stable isotopes of water in hydrology are that they are applied naturally over the whole drainage basin via precipitation, they are conservative, they undergo fractionation during evaporation and condensation, differentiating the isotopic signature of rainfall and groundwater, the latter often having a uniform isotopic signature throughout an entire catchment [41]. Because of fractionation, the isotopic composition of precipitation changes in space and time, decreasing with decreasing surface air temperature, increasing latitude, increasing altitude, increasing distance of vapour transport and increasing amounts of precipitation [117]. Many groundwaters (especially deep or large groundwater bodies) show little variation in isotopic composition with time and reflect the mean isotopic composition of local precipitation. Craig [118] recognized that deuterium and oxygen-18 in precipitation and natural waters of meteoric origin are linearly correlated according to the equation  $\delta\text{D}(\text{‰}) = 8 \delta^{18}\text{O} + 10$  which is known as the Global Meteoric Water Line (GMWL). The value of the intercept (+10) is called the ‘deuterium excess’, which is produced by kinetic effects during evaporation and which varies with geographic location [119]. For water subjected to evaporation, the linear correlation between D and  $^{18}\text{O}$  values still holds, but has a lower slope (4 or 5 rather than 8) (Rozanski et al., 2001). The meteoric water line is therefore a kind of reference line against which any measuring point can be compared. The result of the comparison provides a fingerprint of the sample and may serve to identify the origin of the water type.

One of the techniques frequently used by catchment hydrologists to identify different water pathways contributing to stream runoff is chemical hydrograph separation [37, 65, 120]. According to the time source approach described by Sklash and Farvolden [37], stream runoff is composed of water already present in a basin before a snow melt or precipitation event (pre-event or old water) and the water added to a basin by a runoff inducing event (event or new water). Similar to the residence time influence described earlier, the proportions of event and pre-event water can also influence nutrient cycling and biogeochemical reactions in river systems. In other words, event water is typically dilute because there is little opportunity for precipitation (event water) to react with soils or bedrock before it moves into a stream, and in the case of direct precipitation in a river channel, there is no opportunity for interaction. However, pre-event water can be in contact with soils and bedrock for periods of days or longer and have substantially different organic and inorganic compositions than event water. In some arid and semi-arid systems, pre-event water can be months old depending on how long it is between precipitation events that generate flow [121]. The isotopic difference between rainfall and groundwater, taking into account IRMS sensitivity, enables us to separate pre-event water from event water through the simultaneous solving of the following mixing equations, analogous to Eqs (1) and (2) [119, 121, 122]:

$$Q_t = Q_p + Q_e \quad (4)$$

$$\delta_t Q_t = \delta_p Q_p + \delta_e Q_e \quad (5)$$

where  $Q$  is the discharge of the various components [ $\text{L}^3/\text{T}$ ],  $\delta$  is the isotopic signature (‰) and the subscripts  $t$ ,  $p$  and  $e$  refer to the total, pre-event and event water components of a storm hydrograph. The application of this technique assumes that tracers have a conservative behaviour in water, meaning that the tracer concentration changes only through mixing. The precision and successful application of this technique strongly depends on the respect of the following assumptions [37]: (i) the isotopic content of event water must be distinguishable from

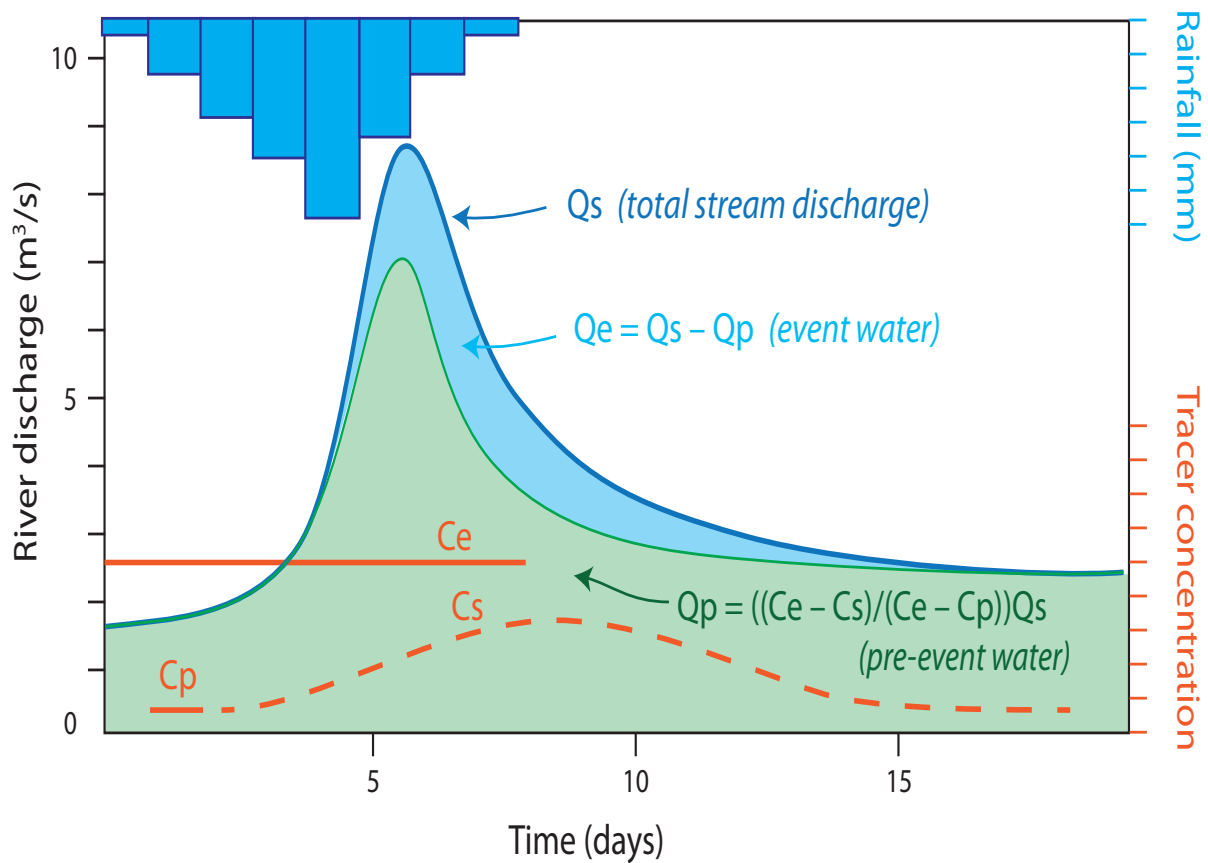

FIG. 3. Generalized diagram of a time source based, two component storm hydrograph separation. The (chemical or isotopic) tracer signatures of pre-event ( $C_p$ ), event ( $C_e$ ) and stream water ( $C_s$ ). The distribution of flow sources, such as measured stream discharge ( $Q_s$ ), event water ( $Q_e$ ) and pre-event water ( $Q_p$ ), and the amount of event water vs. time (adapted from [125]).

that of pre-event water; (ii) the isotopic signature of event water must be constant throughout the event; (iii) groundwater and vadose zone water (together composing the pre-event component) have the same isotopic signature, or vadose water contributions to storm runoff are negligible; (iv) surface storage contributions to stream flow are negligible. The reader is referred to the previous paragraph (*Hydrochemical tracers*) for a discussion on the uncertainty associated with the hydrograph separation technique. Different physical mechanisms have been conceptualized to explain event and pre-event water contributions to stream flow; Refs [41, 67, 123] provide reviews of these mechanisms, and Ref [124] provides a nice field example to describe the factors affecting event and pre-event water contributions. Two and three component storm hydrograph separations have been applied mainly in small and medium sized catchments at mid and high latitude regions, finding a predominance of pre-event water in a storm hydrograph and identifying different pre-event components, besides groundwater, such as unsaturated zone water [65, 66, 72] (Fig. 3). For example, Wallis et al. [72], by means of a three-component hydrograph separation using  $\delta^{18}\text{O}$  and tritium to identify the groundwater, snow and rain contributions to stream flow, found that though groundwater was the largest contributor to

stream discharge throughout the year, it delivered to a stream only a relatively small percentage of the dissolved organic matter.

Stable isotopes, and in particular  $^{18}\text{O}$ , are also useful tracers of surface water–groundwater exchanges. Lambs [98, 126] used  $^{18}\text{O}$  to study groundwater inflows at the confluence of rivers in southwestern France and in the north of India. He found that  $^{18}\text{O}$ , together with EC, was an effective tracer of water movement and could identify water origin. Négrel et al [127] used stable isotopes of water to account for seasonal and spatial variations in surface water–groundwater interactions in an alluvial plain at the confluence of the Loire and Allier rivers in France, as well as for groundwater origin, and  $^{87}\text{Sr}/^{86}\text{Sr}$  isotope ratio are used to infer contributions of groundwater from different flow systems to the surface water system. Other studies demonstrated the effectiveness of strontium isotopes to detect groundwater origin and mixing [127, 128]. La Ruffa et al. [129] measured the evolution of  $\delta^{18}\text{O}$  and  $\delta\text{D}$  along the Arno river (Tuscany, Italy) from the source to the mouth, identifying different contributing sources to the river's discharge.

Stable isotopes of nitrogen are very often valuable tools in determining occurrence and rates of biological mediated reactions which may affect nutrient loads to rivers and groundwater quality. The reader is referred to the other sections in the present volume for nitrogen isotope systematics and applications.

**Radioactive isotopes:** Radionuclides are unstable atoms which undergo radioactive decay. If a radioactive element from an atmospheric source enters groundwater, from the value at recharge, concentration can decrease over time because of radioactive decay and exchange processes with the rock matrix. At the same time, subsurface sources can add nuclides to groundwater (i) through transfer processes from sites of production inside the solid phase; (ii) through production within the liquid phase; (iii) through fluxes from reservoirs where nuclides might have accumulated over longer periods of time [130]. If radioactive decay is the dominant process, changes in concentration and isotope half-life ( $T_{1/2}$ ) can be used to investigate timescales of hydrological processes and water movement.

Tritium ( $^3\text{H}$ ) ( $T_{1/2} = 12.43$  a), and carbon-14 ( $^{14}\text{C}$ ) ( $T_{1/2} = 5739$  a), are both naturally produced radio-isotopes. However, substantial amounts of tritium in particular were added to the atmosphere with nuclear weapon testing mainly in the 1960s creating an excellent hydrologic tracer. Carbon-14 was also added through nuclear testing, although most hydrological studies focus on naturally produced  $^{14}\text{C}$  generated through cosmic radiation. These two radioisotopes are the most relevant radio-tracers used in studies of the hydrologic cycle, because they can be quite effective for measuring the age of groundwater (the period of time elapsed since the water infiltration into the recharge zone), and mixing between different reservoirs. Owing to their half-lives, they can be used to date recent ( $^3\text{H}$ ) and old groundwater ( $^{14}\text{C}$ ). An in-depth review of these techniques is given by Mook [83].

Among the products of the natural radioactive decay series of  $^{238}\text{U}$ ,  $^{226}\text{Ra}$  (radium,  $T_{1/2} = 1620$  a) and its daughter product,  $^{222}\text{Rn}$  (radon,  $T_{1/2} = 3.82$  d), are valuable tools in surface–subsurface water interactions studies. In particular, the natural occurring radioactive gas  $^{222}\text{Rn}$  (radon) is noteworthy as a tracer because it is a powerful tool to detect and quantify groundwater inputs to rivers [131], as well as to estimate the residence time of surface water within streambed sediment [59] (see section 5 in this volume). Nevertheless, it is worth mentioning that the  $^{234}\text{U}/^{238}\text{U}$  activity ratio has been successfully used by Durand et al. [132] as a tracer of deep groundwater

input to the Rhine River (Germany) and that  $^{226}\text{Ra}$  has been used as a conservative chemical tracer for mixing of different water masses having significantly different  $^{226}\text{Ra}$  concentrations, and to detect groundwater inputs to surface water bodies [133, 134].

### 3.2. Small scale investigations

Processes occurring at the reach or sub-reach scale more directly influence nutrient transport to rivers than larger scale processes. In fact, nutrients transported by surface or subsurface water pathways undergo uptake and degradation by living organisms in the riparian and hyporheic zones [12, 39]. The investigation of processes occurring when subsurface water mixes with surface water within streambeds and stream bank sediments are of great importance to elucidate the origin and the mechanisms regulating transport and transformation of nutrients and organic matter to streams. In particular, retention mechanisms are major controls of the nutrient cycling in riverine ecosystems and they can be effectively elucidated at the small scale, though nutrients released in the catchment may be discharged to the stream over a long time frame (for example, at a regional flow system scale) and a short term investigation can miss this contribution. Small scale investigations, carried out at key sites in a catchment, usually aim to identify biogeochemical hot spots often occurring at the surface–subsurface water interfaces [7], to elucidate critical processes or to gain higher spatial resolution of the processes investigated. Hereafter, the tools generally used to study small scale surface–subsurface water interactions are reported. These include field observations, identification of ecological indicators, temperature studies, water budgets, hydrometric analysis, seepage measurements, tracer methods application and hydrochemical determinations [4]. The focus of this section is on tracer methods and in particular on isotope techniques with a minor emphasis on the method principles already described in the Large scale investigations paragraph (§3.1).

**Field observations** are the first direct contact with the study site and may identify hotspots of groundwater inflow to surface water bodies helping to design experimental settings and define monitoring programmes. They are a preliminary visual qualitative analysis based on the reconnaissance of aquatic plants, water clarity, colour and odour, carbonate precipitation, defrosted spots, steaming areas which happen when air temperature is colder than groundwater temperature, and seepage surfaces and springs.

**Ecological indicators** typically refer to faunal or floral communities or specific organisms living at the aquatic–terrestrial interface, which can indicate groundwater discharge to surface water. Groundwater flowing through parafluvial gravel bars or hyporheic sediments may contain high concentrations of dissolved compounds, in particular nutrients, which can feed macrophyte or algal species in outflow and upwelling areas [8, 135]. An overview of the effects that groundwater inflows exert on surface biology is reported in Ref. [136]. Observation of biota may bring important spatial and temporal information about the extent and the direction of groundwater flow and its changes during different stream discharge patterns (such as floods), which can alter a riverine ecosystem structure [20, 137]. The discovery of benthic invertebrates far below riverbed depth was one of the first pieces of evidence, implying existence of the hyporheic zone [80, 138].

**Temperature** is an effective measure that has been used to highlight groundwater/surface water interactions because a consistent difference is usually observed between surface and subsurface water, where the former is subjected to diurnal and seasonal variations, while the latter is relatively constant on a daily scale. Stream temperature is influenced primarily by so-

lar radiation and river flow discharge; other natural influencing factors are evaporation, heat exchange and conduction, snowmelt, groundwater inflows and air temperature. Constantz et al. [74] demonstrated, on a daily scale, the dependency of stream flow loss from stream temperature. Temperature time series measurements of the water column and sediments coupled with a steady one-dimensional fluid flow model [139] permit estimation of seepage flux through the sediments [140]. The assumption of the method is that the propagation of temperature within streambed sediments is related to the direction and magnitude of the seepage flux. However, temperature monitoring has to be coupled with other methods to be effectively used in stream-groundwater exchange studies because local and broader effects may overlap.

**Water budgets** (see also Large scale investigations paragraph, §3.1) are largely applied in small scale investigations to account for net seepage flux occurring in a defined surface water feature (such as a stream reach) by means of discharge measurements. Stream flow may be measured by dilution gaging, 'bucket and stopwatch', velocity area, slope area, and thin plate weir methods [4]. According to Harvey and Wagner [85], groundwater inflow and outflow fluxes occurring simultaneously in a stream reach may be easily estimated by a combined use of velocity area and dilution gaging methods. However, this approach is not able to estimate hyporheic exchange fluxes.

**Hydrometric analysis** (see also large scale investigations paragraph, §3.1), based on Darcy's law, helps to quantify water fluxes across the streambed by means of contour maps of hydraulic head and determination of the hydraulic conductivity of near channel sediments [85]. Minipiezometers [141] installed within the streambed, equipped with a manometer or a stilling well to measure the surface water stage, are very common to determine Vertical Hydraulic Gradients (VHG,  $dh/dl$ ). A VHG is calculated as the difference in hydraulic head ( $dh$ ) divided by depth of piezometer ( $dl$ ); positive VHG indicates upwelling (interstitial water enters the stream) while negative VHG indicates downwelling (stream water infiltrates into the bed sediment). By estimating the hydraulic conductivity of stream bed sediments (carried out by means of seepage meters, infiltration or pump tests, grain size analysis, or laboratory analyses of core samples) and measurement of VHGs, the direction and magnitude of water flux at the stream-aquifer interface can be estimated [8].

**Seepage measurements** are a tool used to directly measure hydrologic fluxes across a stream bed. They are based on the use of seepage meters [142] which collect temporal information about seepage flux by isolating a part of the sediment-water interface with an open base chamber and measuring the change of a known volume of water contained in a bag attached to the chamber over a fixed time. Seepage fluxes estimated in this way help validate seepage fluxes estimated by indirect techniques (such as hydrometrics, tracers, or modelling), but results are limited to a small area and it may be difficult to integrate the information over a bigger (reach) scale.

**Artificial tracers** are chemical compounds (like gases, solids, solutes, or isotopes) deliberately introduced into a flow system in order to study key processes highlighted by tracer behaviour. Artificial tracers can be either conservative or reactive, depending on the process or the mechanism to be tracked. Usually conservative tracers, for example fluorescent dyes (such as uranine) or halogen anions (like  $Cl^-$ ,  $Br^-$ ) are used to elucidate hydrologic processes, such as groundwater inputs to rivers or hydrologic retention (*sensu* [30]) while reactive tracers, such as nitrate or phosphorous, are used to study net processes of solute degradation or adsorption and uptake (biotic retention) [22, 29]. Constant injection of conservative tracers in controlled



flow conditions is a technique (like the stream tracer approach) widely employed to characterize near stream flow systems, inferring information about rates of water exchange between the main stream channel and the hyporheic zone and/or stagnant or slow flowing surface water zones (storage zones). This methodology is also used to estimate the size of the storage zones, where slow flowing water increases solute retention time allowing biota to effectively retain and transform nutrients and organic matter [28, 30, 36].

A solute tracer is injected at an upstream point and then monitored, after complete mixing with stream water has occurred, at downstream points or in streamside wells and piezometers [28, 29]. Measured concentrations at downstream locations are simulated by a transport model which describes solute transport in a stream as mainly governed by advection and dispersion mechanisms and which includes a lateral inflow term and a ‘transient storage’ term to account for mixing with other reservoirs (such as groundwater) and retention mechanisms, respectively [31]. The general equations (for conservative and reactive solutes) for the one dimensional, advective–dispersive transient storage transport model are [85]:

$$\frac{\partial C}{\partial t} = -\frac{Q}{A} \frac{\partial C}{\partial x} + \frac{1}{A} \frac{\partial}{\partial x} \left( AD \frac{\partial C}{\partial x} \right) + \frac{q_L^{in}}{A} (C_L - C) + \alpha (C_s - C) - \lambda C \quad (6)$$

$$\frac{\partial C_s}{\partial t} = \alpha \frac{A}{A_s} (C - C_s) - \lambda_s C_s \quad (7)$$

where  $t$  (t) and  $x$  (L) are time and distance along the stream;  $C$ ,  $C_L$  and  $C_s$  are the solute concentration in the stream, lateral inflow and storage zone ( $M/L^3$ );  $Q$  is the stream discharge ( $L^3/t$ );  $A$  and  $A_s$  are the cross-sectional areas of stream and storage zone ( $L^2$ );  $D$  is the stream dispersion coefficient ( $L^2/t$ );  $q_L$  is the groundwater inflow rate (per length) ( $L^3 \cdot t^{-1} L^{-1}$ );  $\alpha$  is the storage–exchange coefficient ( $t^{-1}$ );  $\lambda$  and  $\lambda_s$  are first-order rate constants ( $t^{-1}$ ) describing the behav-

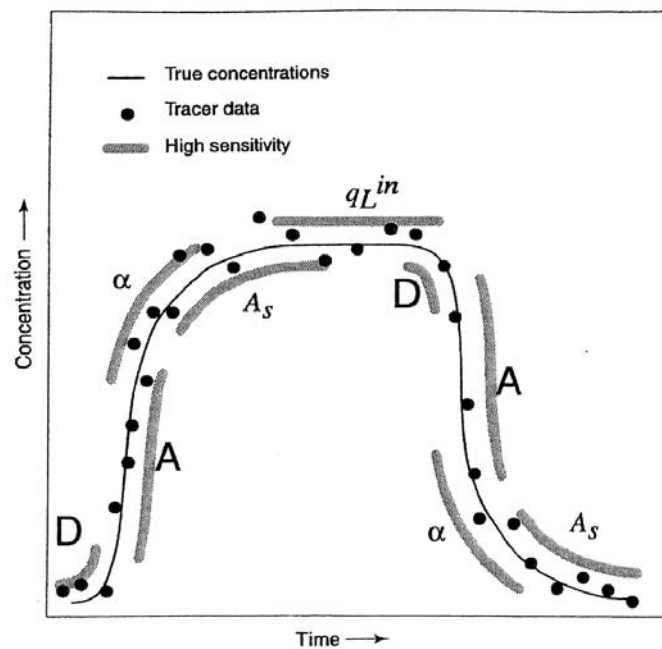

FIG. 4. Simulation of a stream tracer test and regions of sensitivity of the curve to model parameters (see text for definitions) (from Ref. [85]).



tion of a reactive solute because of biological or geochemical processes occurring in the water column or storage zone, respectively.

Storage zones are thus characterized by  $\alpha$ , which is the rate of the exchange flux, and  $A_s$ , which is a measure of stream capacity for storage [85]. Other characterizing parameters are the water exchange flux per unit length,  $q_s = \alpha A$  ( $L^3t^{-1}L^{-1}$ ) and the average residence time of water in the storage zones,  $t_s = A_s/\alpha A$  (t). The fit of the model output to the rising and falling limbs of the tracer breakthrough curve is made adjusting  $\alpha$  and  $A_s$ , which influences early curvature and the velocity at which tracer concentrations reach the plateau or the background conditions [143, 85]. The parameters influencing different parts of the tracer breakthrough curve are illustrated in Fig. 4.

When the stream tracer approach is applied to exclusively characterize hyporheic exchange, a limitation concerning the assumption of a first order mass transfer process to represent the hyporheic exchange arises, which does not allow for possible contributions from other subsurface storage zones [85]. This limitation implies that storage zones are uniquely limited to the hyporheic zone. Surface water storage processes are assumed to be accounted for by the longitudinal dispersion term [144]. Another critical point of the stream tracer approach is the experimental design (including solute injection, reach length and sampling strategy), which will affect reliable estimation of model parameters. Wagner and Harvey [145] defined a procedure to design reliable tracer experiments based on the global parameter uncertainty analysis and proposed the use of the Damkohler number (DaI), which is a dimensionless expression of the relative importance of downstream transport and storage processes, to minimize the uncertainty in mass transfer and storage zone parameter estimates. However, a full comprehension of hyporheic processes requires additional complementary in situ investigation of observables (such as hydrochemistry), because the stream tracer approach elucidates only the timescales and the length scales of the storage.

The majority of stream tracer experiments have been carried out in low order streams, helping to determine control factors in surface–subsurface exchange, such as stream bed topography [33], discharge [144], geologic setting and alluvial characteristics [30], seasonal conditions [36], biotic vs physical retention [28, 29]. Jackman et al. [146] and Wroblicky et al. [46] propose alternative modelling approaches to characterize surface–subsurface water exchanges. A final limitation is that the stream tracer/modelling approach does not work well in loosing reaches.

**Environmental tracers** (see also Large scale investigations paragraph, §3.1), namely physical parameters, dissolved gases, chemical compounds and isotopes, have been effectively employed to elucidate biogeochemical processes occurring at the terrestrial–aquatic interface, influencing primarily nutrient cycling in riverine ecosystems, but also the chemistry of dissolved species, which can be a major cause of poor water quality. As in large scale investigations, environmental isotopes, both stable and radioactive, at small scale studies have been used to solve mixing of different water pools [147], estimate the residence time of water in the hyporheic zone [58] or highlight biota mediated processes (such as denitrification) [6]. Hereafter, some relevant applications of environmental tracers to track nutrient dynamics in relation to hydrologic exchange between surface and subsurface water are provided, examining the importance of isotopes in the clarification of complex biogeochemical processes. The different applications will be described following a conceptual separation between physicochemical and

isotopic tracers, though they are conjunctively used in most cases and are also combined with other techniques.

**Physicochemical tracers:** At the interface between surface water and groundwater, physicochemical gradients are likely to occur because of the mixing of waters with different physicochemical properties, biogeochemical processes and due to the local residence time of water [16, 29]. Hydrochemical surveys carried out at River Glatt field site (Switzerland), where river water and groundwater were sampled for inorganic compound determinations, were able to identify the extent of mixing (by means of  $\text{Cl}^-$ ) and the main biogeochemical processes (degradation of organic matter) taking place when river water locally recharges a portion of an alluvial aquifer [44], causing changes in redox conditions, which in turn influence the precipitation and dissolution of manganese and hence the chemistry of heavy metals (Cr, Cu, Zn, Cd and Pb). Bourg and Bertin [147] realized a similar study in a Lot River transect (France); they identified a zone of oxygen depletion in streamside sediments where infiltrating river water was subjected to degradation of DOC, which enhances denitrification, and dissolution of calcium and magnesium carbonates, which causes the dissolution of manganese oxides; the mixing was estimated using chloride data. Thus, dissolved oxygen highly influences the redox environment of sediments, becoming a major control of nutrient transformations; its presence in river sediments is regulated by hydrologic residence time and biological uptake rates [19], which in turn can be affected by fluctuating river stages [148] resulting in higher dissolved oxygen in downwelling zones than in upwelling zones [8]. The nitrogen biogeochemical cycle, which is strongly dependent on redox conditions, is largely influenced by water exchange between the stream channel and its hyporheic zone [149]. The oxidation state of nitrogen varies from  $-3$  to  $+5$  and is primarily controlled by oxygen and organic carbon availability. In fact, in anoxic environments, nitrate ( $\text{NO}_3^-$ ) is used by bacteria as an alternative electron acceptor to decompose organic matter (denitrification) [149], while ammonium ( $\text{NH}_4^+$ ) is likely to accumulate due to sediment absorption and water residence time [29]. Cru ze des Ch telliens and Reygrobellet [150] identified groundwater inputs to the Rh ne River (France) measuring an increase of nitrate in surface water. The reader is referred to section 2 of the present volume for studies on the nitrogen cycle in aquatic environments.

Riparian zones have been found to be sinks for nutrients and dissolved organic matter transported from upland areas of a catchment to a stream channel [151]. For example, Fiebig et al. [26] measured DOC concentrations of soil water and surface water of a headwater stream and found seasonal variations of DOC release to surface water from streambed immobilization sites. During baseflow conditions, immobilization prevailed, whereas at higher flow, soil water DOC could be directly released into the stream.

The reported studies represent just a few examples of how hydrochemistry of surface and subsurface waters can be very effective in understanding biogeochemical processes occurring in the hyporheic and subsurface riparian zones. The complexity of the exchanges makes it very difficult to draw general a priori conclusions for a given stream, because of the strong dependence on the local setting of a particular stream–aquifer system.

**Isotopic tracers:** In the framework of surface–subsurface water exchange occurring at small scales, stable isotopes are mainly used to identify water origin and to track the evolution of biological processes, such as denitrification, the biotic mediated reduction of  $\text{NO}_3^-$  to  $\text{N}_2$  gas, in the hyporheic and riparian zones. Hill [152] studied the contribution of shallow and deep groundwater to a wetland area of a headwater catchment in Ontario using  $^{18}\text{O}$ . He identified

different hydrologic pathways from the wetland to the stream riparian zone, combining isotopic evidence with chemical measurements of chloride, nitrate, ammonium and dissolved oxygen. However, he was not able to clearly define biological transformations that could alter nitrate along hydrologic pathways through the riparian zone to the stream. Hinkle et al. [38] was able to identify the origin of water within the hyporheic zone by means of  $\delta D$  and  $\delta^{18}O$ , estimating the mixing ratios between regional groundwater and surface water. Biogeochemical processes affecting the fate of nitrogen species in near stream saturated zones, and in particular denitrification, are described in section 2 of the present volume, where nitrogen isotope principles and applications are also reported.

As can be deduced from the small number of examples reported, though the list is not exhaustive, the use of isotopes to study processes occurring at the small scale is still not fully developed, probably because other techniques are still preferred to investigate such complex interactions (such as the stream tracer approach). Usually, isotopes are used as ancillary information to confirm hypotheses drawn by chemical data. Nevertheless, isotopes sometimes clearly identify processes otherwise not 'visible' with other techniques, and their use is highly recommended, especially when hydrological pathways and biologically mediated processes have to be elucidated. Moreover, stable isotopic techniques, in conjunction with groundwater age dating tools (like CFCs), may help to assess the effects of changes in land management practices and land use on water quality. For example, conjunctive use of isotopes and other tracers can provide estimates of groundwater travel times to a stream, as impacted by land use [153]. Among radioactive tracers, the use of  $^{222}Rn$  to quantify hyporheic flux and estimate the residence time of water in the hyporheic zone is worthy of note, and the model described by [58] and implemented by Lamontagne and Cook [59] is described in the case study reported in Section 5 of the present volume.

#### 4. CONCLUDING REMARKS

Nutrient dynamics in lotic ecosystems are strongly influenced by the degree and nature of interactions between surface water and groundwater. Nutrient transformation, retention and release occur preferentially in the transition zone between the terrestrial and the aquatic boundary, which includes both the riparian and the hyporheic zone, the former mainly influenced by catchment hydrology, the latter mainly influenced by stream channel hydraulics. Groundwater discharging from a local flow system to a surface water body usually flows through the transition zone, where its chemistry can be heavily altered by biochemical processes lowering, for example, the nutrient load to streams. The riparian and hyporheic zones in this case act as buffer ecotones, contributing to maintaining riverine ecosystem stability. As Dahm et al. [82] pointed out when referring to the hyporheic zone, 'a clear understanding of the biogeochemistry of this ecotone requires a basic knowledge of system hydrology'. The characterization of water flow paths at the large scale, identifying stream flow generation processes, as well as gaining or losing stream reaches and water residence time in a catchment, and at the small scale, elucidating hyporheic exchange pathways and rates, is essential to understanding nutrient cycling within fluvial ecosystems.

Many techniques and approaches, coming from disparate fields of research, can be effectively used to characterize surface water-groundwater exchanges from a hydrogeological and ecological perspective (see Ref. [154]). As Woessner [9] summarized, characterization of the exchange of groundwater within a river is usually realized by: (i) measuring wa-

ter levels in wells, piezometers and nests of piezometers placed within the alluvial plain, stream banks and the streambed; (ii) performing stream discharge measurements at several cross-sections in a short time period; (iii) comparing groundwater and stream water geochemistry; (iv) applying one dimensional transport modelling. In this context, environmental and artificial tracers are valuable tools which can provide information about water origin, water pathways, the mixing of two or more water pools, the travel time of water from infiltration to discharge areas, occurrence and rates of biogeochemical processes, and location and exchange fluxes of subsurface storage zones.

In particular, isotopes, both stable and radioactive, are establishing themselves as an effective means to answer most questions related to water resources connectivity issues. By means of isotopic techniques, it is possible to quantify the contributions of different sources of water to stream flow, during high flow and/or baseflow conditions (using  $\delta D$  and  $\delta^{18}O$ ), as well as groundwater inputs to rivers (using  $^{222}Rn$ ), to track water origin and flow paths (with  $\delta^{18}O$ ,  $^{87}Sr/^{86}Sr$ ) and/or to estimate residence time of water in a catchment (using  $^3H$  and  $^{14}C$ ) or in the hyporheic zone ( $^{222}Rn$ ).

There are some cautions to consider when using isotopes, and in general tracer techniques. Generally, they can be used only if they have a distinct isotopic signature, or concentration, for the different considered reservoirs to identify or track. Moreover, the use of tracers is very often coupled with a mixing or transport model. Such models usually require several assumptions necessary to represent the system using a mathematical equation. An accurate representation of the assessed phenomena requires that model assumptions are fulfilled or that any deviations from them are accounted for in order to evaluate overall uncertainty.

Given their limitations, it is always desirable, when isotope techniques are used to evaluate groundwater–surface water interactions, to couple them with different methodologies and thus gain a thorough understanding of the studied process from the conjunctive interpretation of different data, especially when optimal conditions for the application of the chosen isotopic method cannot be satisfied. In every case, basic knowledge of the hydrogeology and hydrology of a system needs to be acquired.

The best approach to address a water resources management problem, such as understanding nutrient loading to a stream, is based on interdisciplinary study, and can involve hydrogeologists, stream ecologists, microbiologists, geochemists, geomorphologists and landscape ecologists. Such an interdisciplinary approach is needed because it is necessary to integrate a variety of tools to interpret the processes and mechanisms occurring when surface and subsurface water merge into a unique hydrologic system.

In conclusion, isotopic techniques can be insightful to the comprehension of riverine ecosystem dynamics if they are based on an experimental design that considers the spatial and temporal patterns of interaction between surface water and groundwater. Consideration of spatial and temporal patterns helps one choose the approach that best highlights the processes which are to be studied. As pointed out by Sophocleous [2], an effort to upscale findings from reach scale studies to the catchment scale is also needed for the effective management of connected water resources.

## ACKNOWLEDGEMENTS

The authors would like to thank W. Hadwen for his accurate review of the manuscript. Moreover, L. Stellato would like to thank F. Marzaioli for the enlightening discussions held in the early stages of manuscript writing.

## REFERENCES

- [1] WINTER, T.C., et al. Ground Water and Surface Water A Single Resource. U.S. Geological Survey Circular 1139, Denver, Colorado (1998) 79 p.
- [2] SOPHOCLEOUS, M., Interaction between groundwater and surface water: the state of the science, *Hydrogeol. J.* **10** (2002) 52–67.
- [3] FULLAGAR, I., Rivers and Aquifers: Towards conjunctive water management, Workshop Proceedings, Adelaide 6–7 May (2004) Bureau of Rural Sciences.
- [4] BRODIE, R., et al., An adaptive management framework for connected groundwater-surface water resources in Australia, Bureau of Rural Sciences, Canberra (2007).
- [5] MULHOLLAND, P.J., WEBSTER, J.R., Nutrient dynamics in streams and the role of J-NABS, *J. N. Am. Benthol. Soc.*, **29** 1 (2010) 100–117.
- [6] HINKLE, S.R., et al., Aquifer-scale controls on the distribution of nitrate and ammonium in ground water near La Pine, Oregon, USA, *J. Hydrol.* **333** (2007) 486–503.
- [7] McCLAIN, M.E., et al., Biogeochemical hot spots and hot moments at the interface of terrestrial and aquatic ecosystems, *Ecosystems* **6** (2003) 301–312.
- [8] VALETT, H.M., et al., Vertical Hydrologic Exchange and Ecological Stability of a Desert Stream Ecosystem, *Ecology* **75** 2 (1994) 548–560.
- [9] WOESSNER, W.W., Stream and fluvial plain groundwater interactions: rescaling hydrogeologic thought, *Ground Water* **38** 3 (2000) 423–429.
- [10] BOULTON, A.J., HANCOCK, P.J., Rivers as groundwater-dependent ecosystems: a review of degrees of dependency, riverine processes and management implications, *Aust. J. Bot.* **54** (2006) 133–144.
- [11] EUROPEAN COUNCIL DIRECTIVE 91/676/EEC.
- [12] JONES, J.B., MULHOLLAND, P.J., Streams and Ground Waters, Academic (2000) 425 p.
- [13] HANCOCK, P.J., HUNT, R.J., BOULTON, A.J., Preface: hydrogeoecology, the interdisciplinary study of groundwater dependent ecosystems, *Hydrogeol. J.* **17** (2009) 1–3.
- [14] STEUBE, C., RICHTER, S., GRIEBLER, C., First attempts towards an integrative concept for the ecological assessment of groundwater ecosystems, *Hydrogeol. J.* **17** (2009) 23–35.
- [15] VANNOTE, R.L., et al., The river continuum concept, *Can. J. Fish. Aquat. Sci.* **37** (1980) 130–137.



- [16] BRUNKE, M., GONSER, T., The ecological significance of exchange processes between rivers and groundwater, *Freshw. Biol.* **37** (1997) 1–33.
- [17] FISHER, S.G., LIKENS, G.E., Energy Flow in Bear Brook, New Hampshire: An Integrative Approach to Stream Ecosystem Metabolism, *Ecol. Monogr.* **43** 4 (1973) 421–439.
- [18] GLOSSARY OF ENVIRONMENTAL STATISTICS, Studies in Methods, Series F 67 United Nations, New York (1997).
- [19] GRIMM, N.B., FISHER, S.G., Exchange between interstitial and surface water: Implications for stream metabolism and nutrient cycling, *Hydrobiologia* **111** (1984) 219–228.
- [20] PRINGLE, C.M., Nutrient Spatial Heterogeneity: Effects on Community Structure, Physiognomy, and Diversity of Stream Algae, *Ecology* **71** 3 (1990) 905–920.
- [21] WEBSTER, J.R., Analysis of potassium and calcium dynamics in stream ecosystems on three southern Appalachian watersheds of contrasting vegetation, Dissertation, University of Georgia, Athens, Georgia, USA 9 (1975).
- [22] NEWBOLD, J.D., et al., Phosphorus Dynamics in a Woodland Stream Ecosystem: A Study of Nutrient Spiralling, *Ecology* **64** 5 (1983) 1249–1265.
- [23] POOLE, G.C., et al., Hydrologic spiralling: the role of multiple interactive flow paths in stream ecosystems, *River. Res. Applic.* **24** (2008), 1018–1031.
- [24] MINSHALL, G.W., et al., Interbiome comparison of ecosystem dynamics, *Ecol. Monogr.* **51** (1983) 1–25.
- [25] HYNES, H.B.N., Groundwater and stream ecology, *Hydrobiologia* **100** (1983) 93–99.
- [26] FIEBIG, D.M., et al., Soil water in the riparian zone as a source of carbon for a headwater stream, *J. Hydrol.* **116** (1990) 217–237.
- [27] McMAHON, P.B., BÖHLKE, J.K., Denitrification and mixing in a stream-aquifer system: effects on nitrate loading to surface water, *J. Hydrol.* **186** (1996) 105–128.
- [28] TRISKA, F.J., et al, The role of water exchange between a stream channel and its hyporheic zone in nitrogen cycling at the terrestrial-aquatic interface, *Hydrobiologia* **251** (1993) 167–184.
- [29] TRISKA, F.J., et al., Retention and Transport of Nutrients in a Third-Order Stream in Northwestern California: Hyporheic Processes, *Ecology* **70** 6 (1989) 1893–1905.
- [30] MORRICE, J.A., et al., Alluvial characteristics, groundwater-surface water exchange and hydrological retention in headwater streams, *Hydrol. Process.* **11** (1997) 253–267.
- [31] BENCALA, K.E., WALTERS, R.A., Simulation of solute transport in a mountain pool-and-riffle stream: a transient storage model, *Water Resour. Res.* **19** (1983) 718–724.
- [32] TROTTER, E.H., Woody debris, forest-stream succession, and catchment geomorphology, *J. N Am. Benthol. Soc.* **9** (1990) 141–156.
- [33] HARVEY, J.W., BENCALA, K.E., The effect of streambed topography on surface-sub-surface water exchange in mountain catchments, *Water Resour. Res.* **29** (1993) 89–98.



- [34] MULHOLLAND, P.J., DE ANGELIS, D.L., “Surface-subsurface exchange and nutrient spiralling”, *Streams and Ground Waters* (JONES, J.B., MULHOLLAND, P.J., Eds), Academic (2000) 149–166.
- [35] PRINGLE, C.M, TRISKA, F.J., Effects of Geothermal Groundwater on Nutrient Dynamics of a Lowland Costa Rican Stream, *Ecology* **72** 3 (1991) 951–965.
- [36] HART, D.R., et al., Relationships between hydraulic parameters in a small stream under varying flow and seasonal conditions, *Hydrol. Process.* **13** (1999) 1497–1510.
- [37] WINTER, T.C., et al., Recent advances in understanding the interaction of ground water and surface water, *Rev. Geophys.* **33** AGU suppl. (1995) 985–994.
- [38] HINKLE, S.R., et al., Linking hyporheic flow and nitrogen cycling near the Willamette River – a large river in Oregon, USA, *J. Hydrol.* **244** (2001) 157–180.
- [39] BOULTON, A.J., DATRY, T., KASAHARA, T., MUTZ, M., STANFORD, J.A., Ecology and management of the hyporheic zone: stream–groundwater interactions of running waters and their floodplains, *J. N. Am. Benthol. Soc.* **29** 1 (2010) 26–40.
- [40] SKLASH, M.G., FARVOLDEN, R.N., The role of groundwater in storm runoff, *J. Hydrol.* **43** (1979) 45–65.
- [41] BUTTLE, J.M., Isotope hydrograph separations and rapid delivery of pre-event water from drainage basins, *Progr. Phys. Geogr.* **18** 1 (1994) 16–41.
- [42] GENEREUX, D.P., et al, Use of radon–222 and calcium in a three-end-member mixing model for streamflow generation on the west fork of Walker Branch watershed, *J. Hydrol.* **142** (1993) 167–211.
- [43] NÉGREL, Ph., et al., Surface water-groundwater interactions in an alluvial plain: chemical and isotopic systematics, *J. Hydrol.* **277** (2003) 248–267.
- [44] VON GUNTEN, H.R., KULL, T.P., Infiltration of inorganic compounds from the Glatt river, Switzerland, into a groundwater aquifer, *Water Air Soil Pollut.* **29** (1986) 333.
- [45] CIRMO, C.P., MCDONNELL, J.J., Linking hydrological and biogeochemical controls of nitrogen transport in near-stream zones of temperate-forested catchments: a review, *J. Hydrol.* **199** (1997) 88–120.
- [46] WROBLICKY, G.J., et al., Seasonal variation in surface-subsurface water exchange and lateral hyporeic area of two stream-aquifer systems, *Water Resour. Res.* **34** (1998) 317–328.
- [47] CLARK, I., FRITZ., P., *Environmental isotopes in hydrogeology*, Lewis Publishers, Boca Raton, New York (1997) 328 p.
- [48] KENDALL, C., MCDONNELL, J.J., *Isotope Tracers in Catchment Hydrology*, Elsevier (1998) 839.
- [49] COOK, P., HERCZEG, A.L., *Environmental tracers in subsurface hydrology*, Kluwer Academic Publishers (2000) 529 p.
- [50] RODGERS, P., et al., Using stable isotope tracers to identify hydrological flow paths, residence times and landscape controls in a mesoscale catchment, *Hydrol. Earth Syst. Sci. Discuss.* **2** (2005) 1–35.

- [51] VITVAR, T., et al., “A review of isotope applications in catchment hydrology”, *Isotopes in the Water Cycle* (AGGARWAL, P.K., GAT, J.R., FROELICH, K.F.O., Eds), IAEA/Springer, Dordrecht, The Netherlands (2005) 151–169.
- [52] LEE, R., HOLLYDAY, E.F., “Use of radon measurements in Carter’s Creek, Maury County, Tennessee, to determine location and magnitude of groundwater seepage”, *Field studies of radon in rocks, soil and water*, (GUNDERSEN, L.C., WANTY, R.B., Eds), C.K. Smoley, Boca Raton, Florida (1991) 237–242.
- [53] GENEREUX, D.P., HEMOND, H.F., Naturally occurring Radon  $^{222}$  as a tracer for streamflow generation: steady-state methodology and field example, *Water Resour. Res.* **26** 12 (1990) 3065–3075.
- [54] ROGERS, A.S., Physical behaviour and geologic control of radon in mountain streams, *Geological Bulletin No. 1052-E*, U.S. Geological Survey (1958).
- [55] ELLINS, K.K., et al., Using  $^{222}\text{Rn}$  to examine groundwater/surface discharge interaction in the Rio Grande de Manati, Puerto Rico, *J. Hydrol.* **115** (1990) 319–341.
- [56] LEE, R., HOLLYDAY, E.F., “Radon measurements in stream to determine location and magnitude of ground-water seepage”, *Radon, radium and other radioactivity in groundwater* (GRAVES, B., Ed.), Chelesea, Mich., Lewis Publishers, Inc. (1987) 241–249.
- [57] COOK, P.G., et al., Determining natural groundwater influx to a tropical river using radon, chlorofluorocarbons and ionic environmental tracers, *J. Hydrol.* **227** (2003) 74–88.
- [58] COOK, P.G., et al., Quantifying groundwater discharge to streams using dissolved gas tracers  $^{222}\text{Rn}$  and  $\text{SF}_6$ , Cockburn River, Southeastern Australia, *Water Resour. Res.* **42** (2006). W10411.
- [59] LAMONTAGNE, S., COOK, P.G., Estimation of hyporheic water residence time in situ using  $^{222}\text{Rn}$  disequilibrium, *Limnol. Oceanogr.: Methods* **5** (2007) 407–416.
- [60] POOLE, G.C., Stream hydrogeomorphology as a physical science basis for advances in stream ecology, *J. N. Am. Benthol. Soc.* **29** 1 (2010) 12–25.
- [61] HORTON, R.E., The role of infiltration in the hydrologic cycle, *Trans. Am. Geophys. Union* **14** (1933) 446–460.
- [62] WHIPKEY, R.Z., “Theory and mechanics of subsurface stormflow”, *Proc. Int. Symp. on Forest Hydrology*, Pa., State Univ., University Park, Pa. (1967).
- [63] DUNNE, T., BLACK, R., An experimental investigation of runoff production in permeable soils, *Water Resour. Res.* **6** (1970) 478–490.
- [64] ALEXANDER, R.B., et al., Differences in phosphorous and nitrogen delivery to the Gulf of Mexico from the Mississippi River basin, *Environ. Sci. and Technol.*, **42** (2008) 822–830.
- [65] OGUNKOYA, O.O., JENKINS, A., Analysis of storm hydrograph and flow pathways using a three-component hydrograph separation model, *J. Hydrol.* **142** (1993) 71–88.
- [66] WADDINGTON, J.M., et al., Runoff mechanisms in a forested groundwater discharge wetland, *J. Hydrol.* **147** (1993) 37–60.

- [67] GENEREUX, D.P., HOOPER, R.P., “Oxygen and hydrogen isotopes in rainfall-runoff studies”, *Isotope Tracers in Catchment of Hydrology* (KENDALL, C., McDONNELL, J.J., Eds), Elsevier, Amsterdam (1998) 839 p.
- [68] CARPENTER, S.R., et al., Nonpoint pollution of surface waters with phosphorous and nitrogen, *Ecol. Appl.* **8** (1998) 559–568.
- [69] HOWARTH, R.W., et al., Regional nitrogen budgets and riverine N & P fluxes for the drainages to the North Atlantic Ocean: Natural and human influences, *Biogeochemistry* **35** (1996) 75–139.
- [70] BEVEN, K., “Runoff generation in semi-arid areas”, *Dryland Rivers: Hydrology and Geomorphology of Semi-arid Channels* (BULL, L.J., KIRKBY, M.J., Eds) John Wiley and Sons, Chichester (2002) 57–105.
- [71] NEWMAN, B.D., et al., Surface water-groundwater interactions in semiarid drainages of the American Southwest, *Hydrol. Process.* **20** (2006) 3371–3394.
- [72] WALLIS, P.M., et al., The importance of groundwater in the transportation of allochthonous dissolved organic matter to the streams draining a small mountain basin, *Hydrobiologia* **79** (1981) 77–90.
- [73] WARD, J.V., STANFORD, J.A., Thermal responses in the evolutionary ecology of aquatic insects, *Annu. Rev. Entomol.* **27** (1982) 97–117.
- [74] CONSTANTZ, J., et al., Influence of diurnal variations in stream temperature on streamflow loss and groundwater recharge, *Water Resour. Res.* **30** (1994) 3252–3264.
- [75] SEAR, D.A., et al., Groundwater dominated rivers, *Hydrol. Process.* **13** (1999) 255–276.
- [76] HOLMES, R.M., “The importance of ground water to stream ecosystem function”, *Streams and Ground Waters*, (JONES, J.B., MULHOLLAND, P.J., Eds), Academic (2000) 137–148.
- [77] O’CONNOR, B.L., HONDZO, M., Enhancement and inhibition of denitrification by fluid-flow and dissolved oxygen flux to stream sediments, *Environ. Sci. Technol.* **42** (2008) 119–125.
- [78] BAKER, M.A., DAHM, C.N., VALETT, H.M., “Anoxia, anaerobic metabolism and biogeochemistry of the stream-water-ground-water interface”, *Streams and Ground Waters* (JONES Jr., J.B., MULHOLLAND, P.J., Eds), Academic Press, San Diego (2000) 259–284
- [79] TÓTH, J., A theoretical analysis of groundwater flow in small drainage basins, *J. Geophys. Res.* **68** (1963) 4785–4812.
- [80] ORGHIDAN, T., Ein Neuer Lebensraum des unterirdischen wassers, der hyporhische biotop, *Arch. Hydrobiol.* **55** (1959) 392–414.
- [81] STANFORD, J.A., WARD, J.V., The hyporeic habitat of river ecosystems, *Nature* **335** (1988) 64–66.
- [82] DAHM, C.N., et al., Nutrient dynamics at the interface between surface waters and groundwaters, *Freshw. Biol.*, **40** (1998) 427–451.

- [83] MOOK, W.G., “Introduction – Theory, Methods and Review”, Environmental isotopes in the hydrological cycle: Principle and applications, Vol. 1, IAEA (2001), <http://www.iaea.org/programmes/ripc/ih/volumes/volume1.htm>.
- [84] STELLATO, L., “Isotopic methodologies: a valuable tool to study stream water-groundwater interactions”, Horizons in Earth Science Research. Vol. 1, Ch. 8, (VERESS, B., SZIGETHY, J., Eds), Nova Science Publishers, Inc., ISBN: 978–1–60741–221–2 (2010).
- [85] HARVEY, J.W., WAGNER, B.J., in Streams and Ground Waters, (JONES, J.B., MULLHOLLAND, P.J., Eds), Academic (2000) 4–45.
- [86] HUGGENBERGER, P., et al., Abiotic aspects of channels and floodplains in riparian ecology, *Freshw. Biol.* **40** (1998) 407–425.
- [87] WINTER, T.C., Relation of stream, lakes, and wetlands to groundwater flow systems. *Hydrogeol. J.* **7** (1999) 28–45.
- [88] BUSSINESQ, J., Recherches theoriques sur l’ecoulement des nappes d’equ infiltrées dans le sol et sur les debits des sources, *J. Math. Pures Appl*, Paris **10** (1904) 5–78.
- [89] FETTER, C.W., Applied Hydrogeology, Prentice-Hall, Upper Saddle River, NJ (2001) 598 p.
- [90] DARCY, H., Les fontaines publiques de la ville de Dijon (DALMONT, V., Ed.), Paris (1856).
- [91] BALLESTER, M.V.R., et al., “Physical and human controls on the carbon composition of organic matter in tropical rivers: an integrated analysis of landscape properties and river isotopic composition”, Application of Isotope Techniques for Assessing Nutrient Dynamics in River Basins, IAEA, Vienna (in preparation).
- [92] SANGREY, D.A., et al., Groundwater response to precipitation with application to slope stability. Report to U.S. Geological Survey under Grant 9-6101-05813, Department of Civil Engineering, Carnegie-Mellon University (1982) 33 p.
- [93] SANGREY, D.A., et al., Predicting ground-water response to precipitation, *ASCE J. Geotech. Eng.* **110** 7 (1984) 957–975.
- [94] ARNOLD, J.G., et al., A comprehensive surface-groundwater flow model, *J. Hydrol.* **142** (1993) 47–69.
- [95] EBERTS, S.M., BLAIR, E.S., Simulated effects of quarry dewatering near a municipal well field, *Groundwater* **28** 1 (1990) 37–47.
- [96] COOK, P.G., BÖHLKE, J.K., “Determining timescales for groundwater flow and solute transport”, Environmental tracers in subsurface hydrology, (COOK, P., HERCZEG, A.L., Eds), (2000) 1–30.
- [97] WILCOCK, R., et al., Characterization of lowland streams using a single station diurnal curve analysis model with continuous monitoring data for dissolved oxygen and temperature, *N. Z. J. Mar. Freshw. Res.* **32** (1998) 67–79.
- [98] LAMBS, L., Correlation of conductivity and stable isotope  $^{18}\text{O}$  for the assessment of water origin in river system, *Chem. Geol.* **164** (2000) 161–170.

- [99] CHOI, J., et al., Modelling CO<sub>2</sub> degassing and pH in a stream–aquifer system, *J. Hydrol.* **209** (1998) 297–310.
- [100] DEUTSCHE, W., *Groundwater Geochemistry: Fundamentals and Applications to Contamination*, Lewis, New York (1997).
- [101] HERCZEG, A.L., EDMUNDS, W.M., “Inorganic ions as tracers”, *Environmental tracers in subsurface hydrology* (COOK, P., HERCZEG, A.L., Eds), (2000) 31–78.
- [102] PINDER, G.F., JONES, J.F., Determination of the ground-water component of peak discharge from the chemistry of total runoff, *Water Resour. Res.* **22** (1969) 438–445.
- [103] CHRISTOPHERSEN, N., et al., Modelling streamwater chemistry as a mixture of soilwaters end-members — a step towards second generation acidification models, *J. Hydrol.* **142** (1990) 307–320.
- [104] HOOPER, R.P., et al., Modelling streamwater chemistry as a mixture of soilwaters end-members—an application to the panola mountain catchment, Georgia USA, *J. Hydrol.* **116** (1990) 321–343.
- [105] GENEREUX, D., PRINGLE, C., Chemical mixing model of streamflow generation at La Selva Biological Station, Costa Rica, *J. Hydrol.* **199** (1997) 319.
- [106] GENEREUX, D., Comparison of naturally-occurring chloride and oxygen–18 as tracers of interbasin groundwater transfer in lowland rainforest, Costa Rica, *J. Hydrol.* **295** (2004) 17.
- [107] ESHELMANN, K.N., et al., Interactions between surface water and groundwater in a Virginia coastal plain watershed, *Va. Water Resour. Center Bull.* **174** (1992).
- [108] MULHOLLAND, P.J., Hydrometric and stream chemistry evidence of three storm flowpaths in Walker Branch Watershed, *J. Hydrol.* **151** (1993) 291–316.
- [109] GENEREUX, D., Quantifying uncertainty in tracer-based hydrograph separations, *Water Resour. Res.* **34** 4 (1998) 915–919.
- [110] PHILLIPS, D.L., GREGG, J.W., Uncertainty in source partitioning using stable isotopes, *Oecologia* **127** (2001) 171–179.
- [111] KIRCHNER, J.W., et al., Fractal stream chemistry and its implications for contaminant transport in catchments, *Letters to Nature* **403** (2000) 524–526.
- [112] GRIFFITHS, J., et al., Variability of dissolved CO<sub>2</sub> in the Pang and Lambourn Chalk rivers, 2007, *Hydrol. Earth. Syst. Sci.* **11** 1 (2007) 328–339.
- [113] PLUMMER, L.N., BUSENBERG, E., “Chlorofluorocarbons”, *Environmental tracers in subsurface hydrology* (COOK, P., HERCZEG, A.L., Eds), (2000) 441–478.
- [114] INTERNATIONAL ATOMIC ENERGY AGENCY, *Use of Chlorofluorocarbons in Hydrology: A Guidebook*, IAEA, Vienna (2006) 277 pp.
- [115] SEGAL-ROZENHAIMER, M., et al., Sources and transformation of nitrogen compounds along the lower Jordan river, *J. Environ. Qual.* **33** (2004) 1440–1451.
- [116] DE GROOT, P.A., *Handbook of stable isotope analytical techniques*, Vol. 1., Elsevier (2004).



- [117] DANSGAARD, W., Stable isotopes in precipitation, *Tellus* **16** (1964) 436–468.
- [118] CRAIG, H., Isotopic variations in meteoric waters, *Science* **133** (1961) 1702–1703.
- [119] CRISS, R.E., *Principles of stable isotope distribution*, Oxford University Press, Oxford (1999).
- [120] HOOPER, R.P., SCHOEMAKER, C.A., A Comparison of Chemical and Isotopic Hydrograph Separation, *Water Resour. Res.* **22** 10 (1986) 1444–1454.
- [121] NEWMAN, B.D., et al., Lateral subsurface flow pathways in a semiarid ponderosa pine hillslope, *Water Resour. Res.* **34** (1998) 3485–3496.
- [122] ROZANSKI, K., et al., “Surface water”, *Environmental isotopes in the hydrological cycle. Principle and applications*, IAEA (2001) Vol. III, <http://www.iaea.org/programmes/ripc/ih/volumes/volume3.htm>.
- [123] SKLASH, M.G., “Environmental isotope studies of storm and snowmelt runoff generation”, *Process Studies in Hillslope Hydrology* (ANDERSON, M.G., BURT, T.P., Eds), Wiley, Chichester (1990) 401–435.
- [124] McDONNELL, J.J., A rationale for old water discharge through macropores in a steep, humid catchment, *Water Resour. Res.* **26** (1990) 2821–2832.
- [125] ANDERSON, M.G., BURT, T.P., (Eds.), *Process Studies in Hillslope Hydrology*, John Wiley & Sons Ltd., Chichester, West Sussex, U.K. (1990) 539.
- [126] LAMBS, L., Interactions between groundwater and surface water at river banks and the confluence of rivers, *J. Hydrol.* **288** (2004) 312–326.
- [127] NÉGREL, Ph., et al., Strontium isotope geochemistry of alluvial groundwater: a tracer for groundwater resources characterisation, *Hydrol. Earth. Syst. Sci.* **8** 5 (2004) 959–972.
- [128] NÉGREL, Ph., PETELET–GIRAUD, Strontium isotopes as tracers of groundwater-induced floods: the Somme case study (France), *J. Hydrol.* **305** (2005) 99–119.
- [129] LA RUFFA, G., et al., “Hydrodrological regime and water resource assessment in the Arno river basin (Italy)”, *Isotope techniques in water resources development and management*, Proc. Symp. Vienna 10–14 May 1999.
- [130] LEHEMANN, B.E., PURTSCHERT, R., Radioisotopes dynamics – the origin and fate of nuclides in groundwater, *Appl. Geochem.* **12** (1997) 727–738.
- [131] STELLATO, L., et al., Some limitations in using  $^{222}\text{Rn}$  to assess river–groundwater interactions: the case of Castel di Sangro alluvial plain (Central Italy), *Hydrogeol. J.* **16** 4 (2008) 701–712.
- [132] DURAND, S., et al., U isotope as tracers of groundwater inputs into surface waters: example of the upper Rhine hydrosystem, *Chem. Geol.* **220** (2005) 1–19.
- [133] MILLER, R.L., et al., Radium and Radon in Charlotte harbor estuary, Florida, *East Coast Shelf Sci.* **31** (1990) 439–457.



- [134] KRAEMER, T.F., GENEREUX, D., “Applications of Uranium- and Thorium-series radionuclides in catchment hydrology studies”, *Isotope tracers in catchment hydrology* (KENDALL, C., McDONNELL, J.J., Eds), Elsevier (1998) 679–722.
- [135] WHITE, D.S., et al., “Groundwater-surface water interactions and the distribution of aquatic macrophytes”, *Proc. First Conference On Groundwater Ecology* (STANFORD, J.A., SIMMONS, J.J., Eds), American Water Resources Association, Bethesda MD (1992).
- [136] DENT, C.L., et al., “Subsurface influences on surface biology”, *Streams and Ground Waters* (JONES, J.B., MULHOLLAND, P.J., Eds), Academic (2000) 381–404.
- [137] VERVIER, P., et al., Role of interaction zones between surface and groundwaters in DOC transport and processing considerations for river restorations, *Freshw. Biol.* **29** (1993) 275–284.
- [138] WARD, J.V., *Aquatic Insect Ecology, Vol. 1, Biology and habitat*, Wiley (1992) New York.
- [139] STALLMAN, R.W., Steady one dimensional fluid flow in a semi infinite porous medium with surface temperature, *J. Geophys. Res.* **70** 12 (1965) 2821–2827.
- [140] SILLIMAN, S.E., et al., Quantifying downflow through creek sediments using temperature time series: one-dimensional solution incorporating measured surface temperature, *J. Hydrol.* **167** (1995) 99–119.
- [141] LEE, D.R., CHERRY, J.A., A field exercise on groundwater flow using seepage meters and mini-piezometers, *J. Geol. Edu.* **27** (1978) 6–10.
- [142] LEE, D.R., A device for measuring seepage flux in lakes and estuaries, *Limnol. Oceanogr.* **22** 1 (1977) 140–147.
- [143] STREAM SOLUTE WORKSHOP, Concepts and methods for assessing solute dynamics in stream ecosystems, *J. North Am. Benthol. Soc.* **9** (1990) 95–119.
- [144] HARVEY, J.W., et al., Evaluating the reliability of the stream tracer approach to characterize stream-subsurface water exchange, *Water Resour. Res.* **32** (1996) 2441–2451.
- [145] WAGNER, B.J., HARVEY, J.W., /Experimental design for estimating parameters of rate-limited mass transfer: Analysis of stream tracer studies, *Water Resour. Res.* **33** (1997) 1731–1741.
- [146] JACKMAN, A.P., et al, Transport and concentration controls for chloride, potassium and lead in Uvas creek, a small cobble-bed stream in Santa Clara county, California, USA. 2 Mathematical modelling, *J. Hydrol.* **75** (1984/1985) 111–141.
- [147] BOURG, A.C.M., BERTIN, C., Biogeochemical processes during the infiltration of river water into an alluvial aquifer, *Environ. Sci. Technol.* **27** (1993) 661–666.
- [148] McMAHON, P.B., et al., Hydrologic and geochemical effects on oxygen uptake in bottom sediments of an effluent-dominated river, *Water Resour. Res.* **31** (1995) 2561–2570.
- [149] DUFF, J.H., TRISKA, F.J., Denitrification in sediments from the hyporheic zone adjacent to a small forested stream, *Can. J. Fish. Aquat. Sci.* **47** (1990) 1140–1147.

- [150] CREUZE DES CHATELLIERS, M., REGROBELLET, J.L., Interactions between geomorphological processes and bethic and hyporheic communities: first results on a bypassed canal of the French Upper Rhone River, *Reg. Rivers: Res. Man.* **5** (1990) 139–158.
- [151] CORRELL, D.L., “Buffer zones and water quality protection: general principles”, Buffer zones: their processes and potential in water protection, proceedings of the international conference on buffer zones (Haycock et al., Eds), (1997) 7–20.
- [152] HILL, A.R., Ground water flow paths in relation to nitrogen chemistry in the near-stream zone, *Hydrobiologia* **206** (1990) 39–52.
- [153] BÖHLKE, J.K., DENVER, J.M., Combined use of groundwater dating, chemical and isotopic analyses to resolve the history and the fate of nitrate contamination in two agricultural watersheds, Atlantic coastal plain, Maryland, *Water Resour. Res.* **31**(9) (1995) 2319–2337.
- [154] CLARET, C., BOULTON, A.J., Integrating hydraulic conductivity with biogeochemical gradients and microbial activity along river–groundwater exchange zones in a subtropical stream, *Hydrogeol. J.* **17** (2009) 151–160.



# THE NOBLE GAS RADON ( $^{222}\text{Rn}$ ) AS A HYDROGEOLOGIC TRACER OF GROUNDWATER INPUTS TO RIVERS AND HYPORHEIC EXCHANGE

L. STELLATO

Centre for Isotopic Research on Cultural and Environmental heritage (CIRCE),  
Seconda Università degli Studi di Napoli,  
Caserta, Italy

B.D. NEWMAN

Isotope Hydrology Section,  
International Atomic Energy Agency,  
Vienna, Austria

## Abstract

The study of nutrient dynamics in lotic ecosystems often requires background knowledge of the hydrologic processes occurring both at large scales and at small scales in order to adopt effective management practices. In particular, surface water/subsurface water interactions can significantly alter nutrient loading in streams and rivers. Two case studies are reported as examples of large scale and small scale investigations carried out by means of an integrated approach where  $^{222}\text{Rn}$  was used: (i) to determine fractions of groundwater inflow to total discharge of a river and to identify sections with flow-through conditions, applying a degassing corrected, two component mixing model; (ii) to estimate water residence time within the hyporheic zone by applying a solute mass balance equation based on radon disequilibrium between pore water and stream water. The two case studies demonstrate that  $^{222}\text{Rn}$  is an effective tool in the study of interactions between surface and subsurface waters when groundwater inputs to rivers have to be quantified and in estimating the residence time of surface water in the hyporheic zone. However, an integrated approach including other hydrological and biogeochemical measurements is always recommended when complex processes have to be elucidated.

## 1. INTRODUCTION

Interactions occurring at the interface between surface water and groundwater are often very complex and can occur at different spatial and temporal scales (see Ref. [1]). Nutrient loading in rivers and streams can be largely influenced by the extent of the surface water–groundwater exchange, by means of direct nutrient rich groundwater discharge or biotic mediated processes occurring within the streambed sediments at the interface between surface water and groundwater (the hyporheic zone). The reader is referred to Section 1 for a thorough and exemplified discussion on the possible effects of surface water/groundwater interactions on stream functioning and on nutrient cycling and the methodologies to adopt in order to characterize this exchange from a hydrological, biological and ecological point of view.

The application of natural tracer method using radioactive tracers, like  $^{222}\text{Rn}$  (radon), as well as chemical compounds or stable isotopes, is very helpful in characterizing groundwater–surface water exchanges. Hereafter, the basic concepts regarding the use of radon as hydrogeologic tracer are reported.

When a  $^{226}\text{Ra}$  isotope decays ( $^{226}\text{Ra} \rightarrow ^{222}\text{Rn} + \alpha$  particle), a  $^{222}\text{Rn}$  atom emanates from the solid part of the rock or sediment (other atoms may remain embedded in the same or an adjacent grain) and enters the pore space where it accumulates until equilibrium with its parent nuclide is reached, according to the following law:

$$A_t = A_e (1 - e^{-\lambda t}) \quad (1)$$

where  $A_t$  is  $^{222}\text{Rn}$  specific activity (decays per second per mass unit) at time  $t$ ,  $A_e$  is the  $^{222}\text{Rn}$  specific activity at equilibrium with  $^{226}\text{Ra}$  and  $\lambda$  is  $^{222}\text{Rn}$  radioactive decay constant (0.18/d). After about 30 days the amount of radon in the pore space will remain constant, the rate of decay being the same as the emanation rate, assuming that radon is lost only by radioactive decay and produced by emanation from the decay of  $^{226}\text{Ra}$  atoms (closed system) [2]. The equilibrium value depends on the radium content of the solid matrix, the decay of radon, its emanating power and the porosity of the matrix [3]. The noble gas radon, when the pore space is filled with water, is likely to accumulate in groundwater (solubility coefficient = radon concentration in water/r. c. in air = 0.250 at 20°C, 0.57 at 0°C; [4]). The mechanisms regulating radon concentration in water are radioactive equilibrium, recoil diffusion out of the solid phase and losses across the water–air interface (degassing) [5–7]. Radon–222 concentration in surface water is usually much less than that in groundwater because of degassing. The use of  $^{222}\text{Rn}$  as a hydrogeologic tracer to study surface water–groundwater exchange processes is based on the assumption that river water contains a small amount of radon with respect to groundwater because direct contact of the water with the atmosphere and the turbulence of water allow radon to diffuse into the atmosphere (degassing process).

Thus, radon can be effectively used in large scale investigations to map and quantify groundwater inputs into a river (see Section 1 in this volume), which can be insightful for understanding and locating hot spots of elevated nutrient concentrations or cycling (see Refs [6, 8–13]. Downstream of a groundwater inflow to a river, a prompt rise in radon concentration is usually observed, followed by an exponential downstream decrease, mainly because of gas exchange with the atmosphere, described in Eq. (2):

$$Rn_b = Rn_u e^{-kx/v - \lambda x/v} \quad (2)$$

where  $Rn_b$  is radon concentration downstream of a considered reach (concentration units),  $Rn_u$  is radon concentration upstream of that reach (concentration units),  $v$  is stream water velocity (L/t),  $k$  is the constant of volatilization ( $t^{-1}$ ) and  $x$  is the distance between sampling locations (L) or the length of the reach. In Eq. (2), radon loss due to radioactive decay can be neglected ( $k \gg \lambda$ ), hence radon can be used as a conservative tracer and applied in a two component mixing model with a correction accounting only for degassing, to obtain the amount of groundwater contributing to the total stream flow at a certain location, as described by Eqs (3) and (4):

$$Rn_r Q_r = Rn_{gw} Q_{gw} + Rn_b (Q_r - Q_{gw}) \quad (3)$$

$$Q_{gw}/Q_r = (Rn_r - Rn_b)/(Rn_{gw} - Rn_b) \quad (4)$$

where  $Rn_r$  is the radon concentration measured in the river downstream of a considered reach (concentration units),  $Rn_{gw}$  is the radon concentration measured in groundwater (concentration units),  $Rn_b$  is the background radon concentration as calculated by Eq. (2),  $Q_r$  is river discharge

( $L^3/t$ ) and  $Q_{gw}$  is groundwater discharge ( $L^3/t$ ). The average groundwater radon concentration of the basin (equilibrium value is obtained when the emanation rate equals the decay rate, see above) can be determined by sampling springs and wells. The amount of groundwater discharge at a given location is proportional to the difference between the measured ( $Rn_r$ ) and the predicted ( $Rn_b$ ) radon concentration. If no groundwater is seeping,  $Rn_r$  equals  $Rn_b$ .

The need for a degassing correction of the radon mixing model came out after first studies were completed [8, 9, 11], where the contribution of groundwater inflow ( $Q_{gw}$ ) to the total stream discharge ( $Q_d$ ) between two sampling locations was calculated by means of a steady state mixing equation:  $Q_{gw}/Q_d = (Rn_d - Rn_u)/(Rn_{gw} - Rn_u)$ , where  $Rn$  is the radon concentration and the subscripts gw, d and u refer to groundwater, river downstream and upstream stations, respectively, and  $Q_d = Q_u + Q_{gw}$ . Application of the radon mixing model without correction for volatilization partially failed and induced Ellins et al. [6] to quantify groundwater inputs to stream flow in a karst drainage basin of the Rio Grande de Manati (Puerto Rico), applying a degassing correction to the radon mixing model by means of the stagnant film model [14, 15]. According to this approach, the fundamental mechanism dominating radon removal from water is gas exchange with the atmosphere, which is a function of the concentration gradient between water and atmosphere, the thickness of the boundary layer, the turbulence of the stream and its geometry; the loss of radon as a result of radioactive decay was considered negligible, considering distances between the sampling locations and stream flow velocity. After the study of Ellins et al. [6], several studies pointed out the need to determine a reliable expression for the  $^{222}\text{Rn}$  gas exchange rate, which has to be known in order to quantify groundwater inputs from radon levels in groundwater and streams. Moreover, the rate of gas exchange between stream and atmosphere is an important factor for water quality because it is related to reaeration, which controls the biological degradation of organic matter [16]. Field experiments were performed [10, 17, 18] to test the feasibility of  $^{222}\text{Rn}$  as a tracer with the aim of assessing the hydrologic flow paths important in stream flow generation of small streams by means of tracer injections (volatile and conservative) and  $^{222}\text{Rn}$  determinations. Conservative tracers were used to quantify lateral water inflow and volatile tracers provided information about the volatilization of  $^{222}\text{Rn}$ . In a headwater stream in the Huewelerbaach basin (Luxemburg), characterized by a sandstone aquifer, Stellato et al. [19] performed several field experiments during baseflow periods to compare three models of gas exchange in order to reproduce  $^{222}\text{Rn}$  values measured along the stream. Other studies pointed out the importance of intensive or continuous monitoring in systems like rivers where fast dynamics occur [20]. Hofmann et al. [21] performed hydrograph separation before, during and after heavy rain events by means of continuous  $^{222}\text{Rn}$  measurements and  $\delta^{18}\text{O}$  analyses in two selected micro-basins in western Luxembourg.

Later in this chapter, a field study based on an integrated approach is presented [22] where  $^{222}\text{Rn}$  is used as a valuable tool to identify sections of gaining river and flow-through conditions in an alluvial plain in central Italy.

In addition to the previously cited studies, the model developed by Cook et al. [23] is notable because it demonstrated the importance of hyporheic exchange as an additional source of radon to stream water and showed that failure to account for this process can sometimes lead to substantial errors when using  $^{222}\text{Rn}$  to estimate groundwater discharge rates. They quantified groundwater inflows to the Cockburn River (southeastern Australia) by means of  $^{222}\text{Rn}$  data measured in river and groundwater and by simulating, through a numerical flow model, the change in radon concentration along the stream flow direction as a function of groundwater inflow rate, gas exchange, radioactive decay, evaporation, stream flow losses and hyporheic



exchange. Subsequently, Lamontagne and Cook [24], developed a way of using  $^{222}\text{Rn}$  to actually estimate hyporheic exchange and this is discussed later in this section.

In this paper, the feasibility of  $^{222}\text{Rn}$  in investigating groundwater–surface water interactions at large and small scales (see Section 1 in this volume) is demonstrated using two case studies.

## 2. SAMPLING AND ANALYSING RADON

### 2.1. Sampling

Radon is a gas and for this reason contact between samples and the atmosphere has to be minimized during sampling and storage.

Groundwater samples are collected from a faucet at or near to a well head, after running the water source full force for approximately 5–10 minutes in order to obtain water coming from active circulation. This purging can be performed until stable pH and temperature values are obtained. The analytical technique determines the sampling modality. According to the procedure described by USEPA [25] and modified by Belloni et al. [26], in which liquid scintillation counting (see below) is the analytical technique used, a polyethylene tube is connected to the sampling faucet and ten millilitres of water are collected from the tube, avoiding turbulence in the water flow by means of disposable plastic syringes in 20 mL polyethylene teflon coated or glass vials, filled in advance with 10 mL of mineral oil scintillator (such as Packard Mineral Oil). The sample is transferred into the scintillation vial by injecting it under the level of the scintillation liquid and vigorously shaking to effectively trap radon in the scintillation oil, since radon has a higher affinity for the scintillator than for water. The idea is to establish an equilibrium partition of  $^{222}\text{Rn}$  across the air, water and scintillant phases. As long as the partition coefficients are known, complete recovery of  $^{222}\text{Rn}$  in the scintillant phase is not necessary.

Measurements are performed at least three hours after the sampling to allow equilibrium to be reached between the  $^{222}\text{Rn}$  and its daughters and to optimize the counting procedure.

Surface water can be sampled using a syringe by directly withdrawing water from a stream at a mean depth from the water surface of 15 cm, preferably in the middle of the river or where the main flow is supposed to run. If the river is not accessible, sampling can be carried out by means of bailers, submersible pumps or glass bottles, which must be filled leaving no headspace in order to avoid radon degassing as much as possible, then the same procedure described for groundwater samples is followed.

Recently Leaney and Herczeg [27] published an alternative method that can be used for surface water or groundwater radon samples. It is a simple method that uses a plastic (PET) water bottle and a specialized glass nozzle for transferring the sample into a scintillation vial. The method requires construction of the glass nozzle, but it offers a great deal of simplicity in sample handling, excellent detection limits, and low analytical uncertainties.

### 2.2. Analysis

The use of different analytical techniques implies different ways to extract radon from water. Usually a counter is coupled with a degassing unit (for example in Lucas cells analytical tech-

nique), otherwise the decay product of radon can be analysed directly by measuring a water sample (gamma ray counting). There are many ways of measuring radon in water, but liquid scintillation counting (LSC) has been indicated as the best analytical technique for accuracy and precision, for these kind of measurements [26, 28]. This technique is based on the principle that certain materials emit light after their molecules have been excited by collisions with high energy particles (such as the  $\alpha$  and  $\beta$  particles emitted by a radioactive isotope). This process, called luminescence, takes place in a proper liquid (scintillation cocktail), usually composed of a solution fluor (the light emitting component) and an organic solvent. Each incoming particle causes a light flash in the scintillator, which can be detected by a photocathode. The photocathode is coupled with a photomultiplier tube which amplifies the photoelectric effect, resulting in a final pulse which is proportional to the multiplication factor and the energy of the incoming particle [28].  $^{222}\text{Rn}$  is extracted from water using a scintillation solution and directly counted in a liquid scintillation counter. Preferably, a background and a reference sample are counted within a sample measuring session. A lower limit of detection (LLD) of 1 Bq/L, or less, can be easily achieved using an LSC [29]. The LLD depends on the background counting rate, measuring time, fractional counting efficiency and water volume.

LSC seems to be the most attractive technique when a large number of measurements are required, as in, for example, large scale surveys.

Other techniques used to measure dissolved radon in water samples include:

- Gamma spectrometry using the gamma rays from  $^{222}\text{Rn}$  daughters;
- Lucas cell (scintillation chambers) or ionization chambers;
- Radon diffusion chambers.

Portable radon detectors are another measurement technique becoming popular in hydrological studies. In particular, the RAD-7 detector manufactured by DurrIDGE Company has been used effectively to examine groundwater discharge zones. Water samples can be collected and analysed with low detection limits in the laboratory (for example, following the method of Kluge et al. [30]) or measurements can be made directly in the field using different water analysis attachments available from the manufacturer. The portability of the unit makes it possible to collect continuous radon profiles along a stream or river. Examples of the use of the RAD-7 for conducting radon surveys can be found in Burnett et al. [31], Dulaiova et al. [32], Kluge et al. [29].

Moreover, the assessment of rapid exchange processes traced by radon can be carried out also by means of in situ continuous monitoring in order to evaluate the dynamics of the system under study at the appropriate temporal scale [33].

### **3. LARGE SCALE INVESTIGATION CASE STUDY**

The first case study [22] is an example of an integrated strategy to elucidate seasonal changes in river-groundwater interactions in an intra-mountain alluvial aquifer of central Italy (Fig. 1), made of Holocene alluvial deposits mainly distributed along the rivers, and terraced, Upper Pleistocene alluvial deposits.

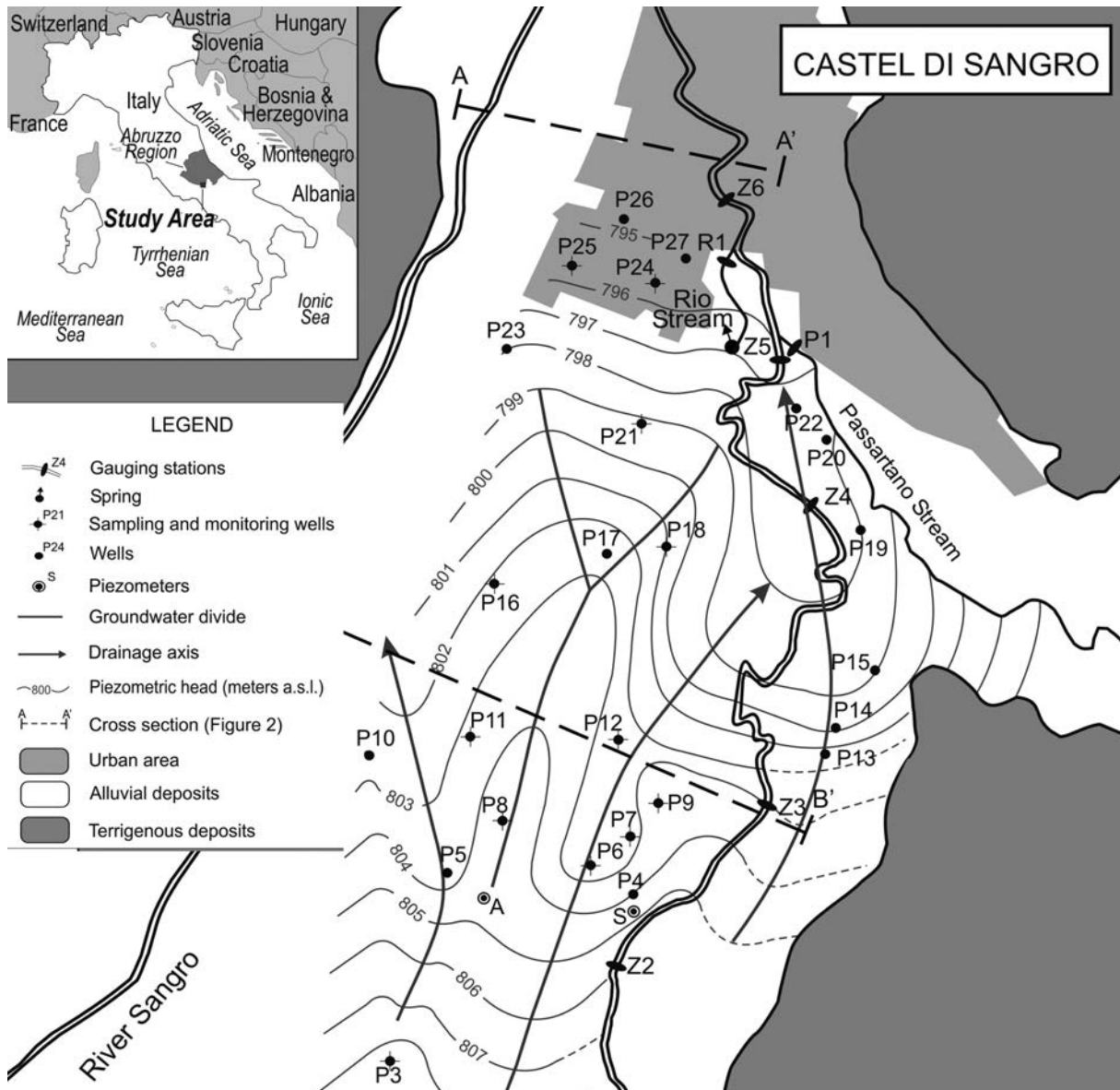

FIG. 1. Field site map. The reported water table map refers to the survey of April 2004 (from Ref. [22], modified).

Groundwater and Zittola river water were sampled across the plain to determine physical-chemical parameters (T, pH and alkalinity), major ion concentrations and radon activity. Stream discharge at various locations and water table levels across the plain were also measured.

Surveys carried out throughout the water year helped delineate an area of groundwater inflow into the stream (Fig. 1 and Table 1) in the northern part of the plain.

Groundwater discharge contributing to stream flow has been quantified using  $^{222}\text{Rn}$  data (corrected for degassing), and stream discharge measurements combined in a two component mixing model (see Eqs 2–4). Gas exchange calculations are based on a turbulent flow model (surface renewal theory [34, 35]). Assuming no groundwater inputs in a given stream reach, the radon concentration at the downstream end is calculated using:

TABLE 1. DISCHARGE MEASUREMENTS (m<sup>3</sup>/s) AND <sup>222</sup>Rn CONCENTRATIONS (Bq/L) IN PARENTHESIS MEASURED IN THE ZITTOLO RIVER (from Ref. [22], modified)

	Distance (km)	NOV. '03	DEC. '03	FEB. '04	MAR. '04	APR. '04	MAY '04	JUN. '04	JUL. '04
Z3	0	– (0.3)	0.54	0.76	0.79	1.65 (1.7)	1.05 (1.9)	0.410 (1.3)	0.13 (0.5)
Z4	1.16	–	–	–	–	– (1.6)	– (2.6)	0.403 (2.6)	0.41 (3.0)
Z5	1.70	–	–	–	0.92 (4.5)	1.11 (3.5)	– (3.6)	0.86 (5.4)	0.49 (5.4)
Z6	2.43	0.83 (3.1)	1.09 (2.9)	0.65 (3.6)	1.33 (4.6)	1.70 (7.3)	1.50 (3.3)	0.99 (4.8)	0.62 (7.1)
Rio	–	–	–	0.13	0.16 (10.5)	0.19 (12.5)	0.16 (10.5)	0.15 (11.1)	0.19 (9.2)

$$Rn_b = Rn_u e^{-[(D \nu)^{0.5}/(h^{1.5})]x/\nu - \lambda x/\nu} \quad (5)$$

where  $Rn_b$  is the calculated radon concentration downstream of a considered reach (Bq/L),  $Rn_u$  is the measured radon concentration upstream of that reach (Bq/L),  $D$  is the radon molecular diffusivity (cm<sup>2</sup>/s, calculated by means of  $-\log D = (980/T^\circ\text{K}) + 1.59$ , [36]),  $h$  is the average stream depth (m),  $\nu$  is the stream water velocity (m/s);  $\lambda$  is the <sup>222</sup>Rn decay constant ( $2.08 \times 10^{-6} \text{ s}^{-1}$ ) and  $x$  is the distance between the upstream and the downstream sampling locations (m). The difference between the calculated ( $Rn_b$ ) and the measured ( $Rn_{meas}$ ) radon concentration at a given location is proportional to the amount of groundwater inflow ( $Q_{gw}$ ), which has a distinct and known radon concentration ( $Rn_{gw}$ ), to the total stream discharge ( $Q_r$ ):

$$Q_{gw}/Q_r = (Rn_{meas} - Rn_b)/(Rn_{gw} - Rn_b) \quad (6)$$

A comparison between groundwater inflow calculations carried out using the radon mixing model and net groundwater inflow measured by stream flow gauging allowed for an estimation of stream flow losses ( $Q_{loss}$  in Table 2; [37]; modified). Assuming no surface water inflow into the considered stream reach, the difference between downstream and upstream discharge ( $Q_d - Q_u$ ) equals the difference between groundwater inflow and stream flow loss ( $Q_{gw} - Q_{loss}$ ). Groundwater inflow estimates from <sup>222</sup>Rn data were always 1.5 to about 5 times greater than the net inflow obtained from stream gauging measurements, indicating stream flow losses are probably due to the meandering shape of the river, which can cause flow-through conditions (see Fig. 1). In the reach Z5–Z6, the two approaches returned the same results (within the error margins), meaning that the only contribution to that reach is Rio stream discharge (see Table 1); this interpretation is supported by the fact that between Z5 and Z6 the river flows in a cemented channel which impedes stream exchange with the groundwater system.

The analysis of chemical compounds, in particular Ca<sup>2+</sup> and Mg<sup>2+</sup> (Fig. 2), indicated spatial and temporal trends of stream–groundwater interactions. The mixing between surface and sub-surface waters occurring downstream at Z3 was also confirmed by major ion concentrations, which were sensitive to variations in stream flow discharge during the dry (July) and the wet (November) seasons. Moreover, during the rising limb stage, groundwater and stream water

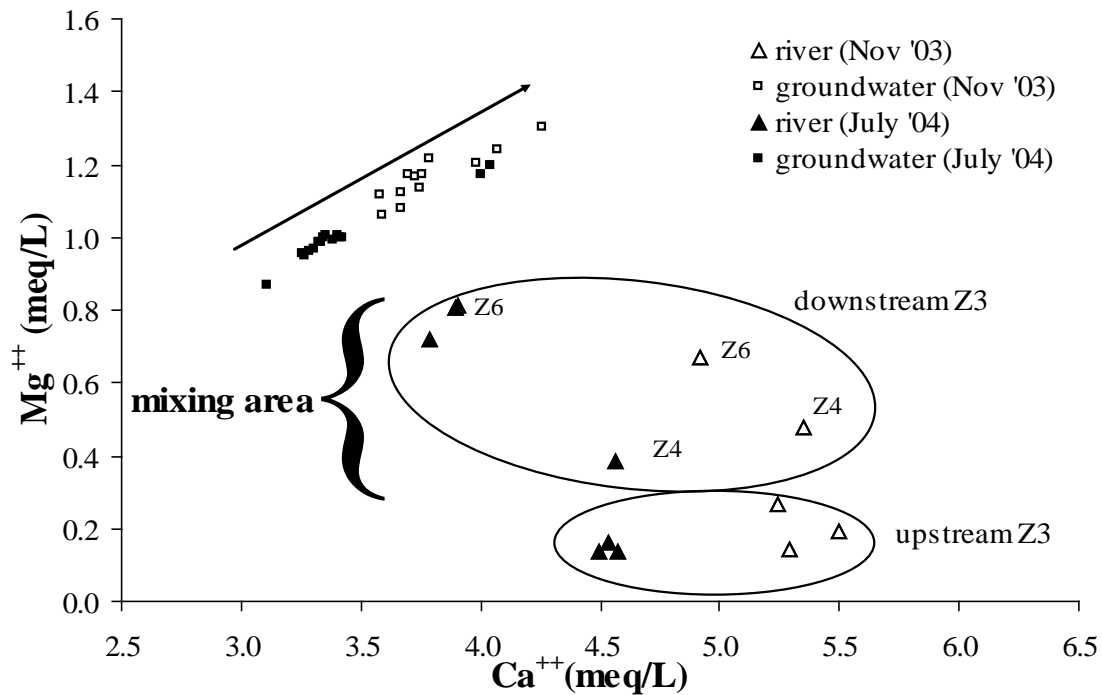

FIG. 2.  $Mg^{++}$  and  $Ca^{++}$  concentrations measured in groundwater and in the Zittola river in the rising limb (November 2003) and in the recession (July 2004) phases. The arrow indicates a solute enrichment along the groundwater flow path.

TABLE 2. NET GROUNDWATER INFLOW AND GROUNDWATER DISCHARGE MEASURED BETWEEN THE INDICATED STREAM REACHES BY MEANS OF STREAM DISCHARGE MEASUREMENTS AND BY  $^{222}Rn$  DETERMINATIONS (<sup>a</sup>) (from Ref. [22] modified)

	June 2004			July 2004		
	Stream flow meas.	Radon mixing model		Stream flow meas.	Radon mixing model	
Stream reaches	$Q_d - Q_u$ (m <sup>3</sup> /s)	$Q_{gw}^a$ (m <sup>3</sup> /s)	$Q_{loss}$	$Q_d - Q_u$ (m <sup>3</sup> /s)	$Q_{gw}^a$ (m <sup>3</sup> /s)	$Q_{loss}$
Z2–Z3	–	0.05±0.01	–	–	0.010± 0.002	–
Z3–Z4	-0.007±0.001	0.12±0.02	0.13±0.03	0.28±0.06	0.18±0.04	-0.10±0.07
Z4–Z5	0.46±0.09	0.68±0.14	0.22±0.19	0.08±0.02	0.38±0.08	0.30±0.09
Z5–Z6	0.12±0.02	0.12±0.02	0.00±0.04	0.13±0.03	0.12±0.02	-0.02±0.04

are more enriched in both cations with respect to samples collected during the recession phase. This pattern is probably influenced by a higher degree of rock dissolution in the recharge phase, since monthly average saturation indexes (see glossary) calculated for all the wells in the plain vary from a maximum of  $0.65 \pm 0.14$  in November 2003 to a minimum of  $0.12 \pm 0.14$  in July 2004 for dolomite, and from a maximum of  $0.33 \pm 0.08$  in November 2003 to a minimum of  $0.08 \pm 0.08$  in July 2004 for calcite.

The reader is referred to Ref. [22] for a detailed description of the study area and further data and discussion.



In conclusion, the combined use of  $^{222}\text{Rn}$  data and major ions concentrations for stream flow and water table level measurements was very effective in elucidating the interactions between surface and sub-surface waters in an alluvial plain environment and the volumes involved. An integrated approach, which provides complementary information obtained from the application of different methodologies, is always desirable to clarify complex hydrological processes occurring in particular hydrogeologic settings.

#### 4. SMALL SCALE INVESTIGATION CASE STUDY

The study reported here is an example of a small scale investigation approach where  $^{222}\text{Rn}$  is shown to be a promising tool to assess hyporheic exchange in situ, by means of the  $^{222}\text{Rn}$  disequilibrium technique. The advantage of such an approach is that it does not require injections of artificial tracers which can be difficult to perform, especially in large river systems.

Lamontagne and Cook [38] define the hyporheic zone as a layer beneath a streambed having the same width  $w$  of the stream, a constant depth  $h$  and a homogeneous concentration of radon  $c_h$ . The underlying assumptions are that diffusion of radon through the sediments is negligible with respect to advection, that hyporheic exchange occurs only vertically (no lateral exchange), and that there is no horizontal downstream flow in the hyporheic zone. In a case where no lateral inflow or loss occurs, the solute mass balance equation in the hyporheic zone is shown by:

$$(wh\theta)dc_h/dt = q_h c - q_h c_h + \gamma wh\theta - \lambda wh\theta c_h \quad (7)$$

where  $q_h$  is the water flux in and out of the streambed sediments ( $\text{L}^3 \cdot \text{t}^{-1} \cdot \text{L}^{-1}$ ),  $c$  and  $c_h$  are the radon concentrations within the stream and the hyporheic zone (unit of concentration),  $\gamma$  is the radon production rate in the hyporheic zone (unit of concentration/t),  $w$  is the stream surface width (L),  $h$  is the mean hyporheic zone depth (L),  $\theta$  is the porosity of the sediments ( $\text{L}^3/\text{L}^3$ ) and  $\lambda$  is the radioactive decay constant of  $^{222}\text{Rn}$  (0.18/d). Concentration within the sediments at a steady state is then:

$$c_h = (q_h c + \gamma wh\theta)/(q_h + \lambda wh\theta) \quad (8)$$

The mean residence time of water within the hyporheic zone is defined as:

$$t_h = wh\theta/q_h \quad (9)$$

Substituting Eq. (9) with Eq. (8) illustrates that hyporheic zone residence times are dependent on the concentration of radon in the hyporheic zone and in stream water, according to the following equation:

$$c_h = (c + \gamma t_h)/(1 + \lambda t_h) \quad (10)$$

Examining Eq. (10) and Fig. 3, one observes that when the residence time of stream water in the hyporheic zone tends to zero,  $c_h$  approaches  $c$ ; this means that for rapid exchange rates (hours to days) radon concentration in the sediments does not have enough time to reach equilibrium with the parent nuclide allocated in the sediment grains. The curves described by Eq. (10) are plotted for a given radon production rate  $\gamma$  in Fig. 3. If production equals the radon decay rate, it determines the plateau concentration of radon within sediments. Curves are



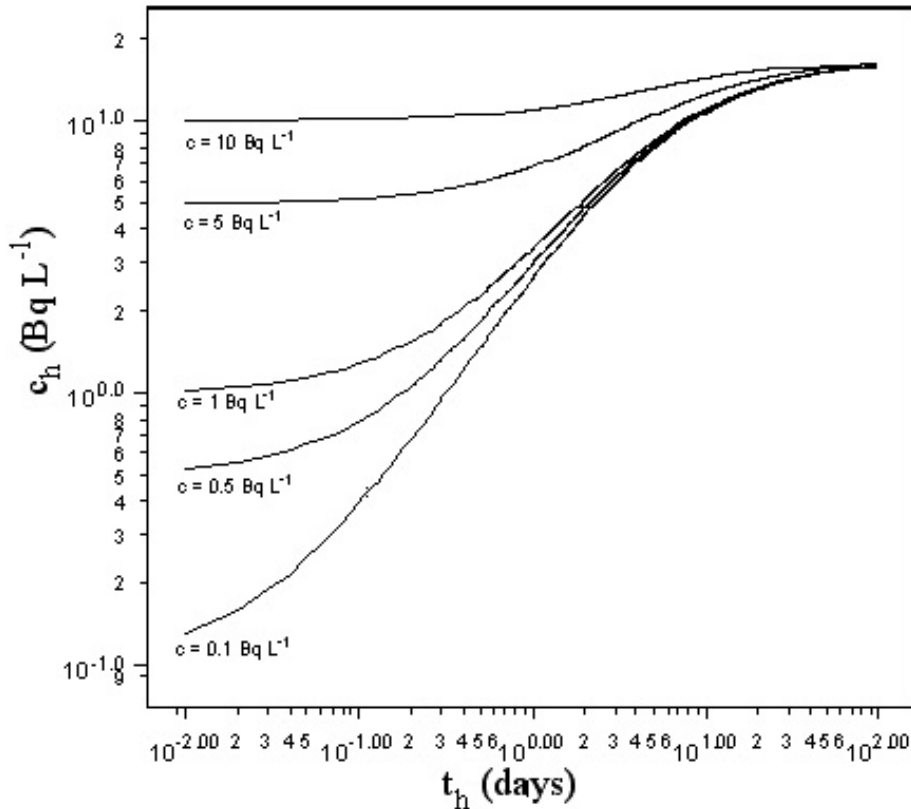

FIG. 3. Simulated hyporheic radon activity concentration vs. residence time of water within the streambed sediments for different stream water radon activity concentrations, for  $g = 3 \text{ Bq}\cdot\text{L}^{-1}\cdot\text{d}^{-1}$  (modified from Ref. [38]), plotted on a Log–Log graph.

shown for different activity concentrations  $c$  of radon in the stream. The uncertainty of residence time estimations increases in regions of the curve ( $c_h$  vs  $t_h$ ) where the first derivative tends to zero; this means that, for given uncertainties in  $c$ ,  $c_h$  and  $\gamma$  measurements, the error in  $t_h$  estimations increases when approaching flat sections of the curve, thus defining the upper detection limit (generally for  $t_h > 20$  d) and the lower detection limit of the method. In other words, the method is not applicable when the residence time is too short or too long to observe a significant change in hyporheic radon concentration compared to measurement errors.

Conversely, stream water concentration is influenced by the residence time of water in sediments, meaning that for high turnover rates, surface water will quickly displace equilibrated interstitial water, supplying sometimes consistent radon activities to streams [23]. This technique is applicable in the range of turnover times of hours to days, usually needed to elucidate surface–subsurface water exchanges.

In a previous study, Lamontagne and Cook [38] carried out a field survey at the Cockburn River site along a stream reach of a few hundred meters, characterized by a shallow (10–100 cm), coarse sand, gravel and cobble stream bed and a baseflow of about  $0.08 \text{ m}^3/\text{s}$  (Swamp Oak Creek site). The aim of the study was to test  $^{222}\text{Rn}$  as a tool to assess the exchange rate between surface water and hyporheic zone water.

During a three day field campaign, samples for  $^{222}\text{Rn}$ , major ions and  $\text{SF}_6$  concentrations were collected, in addition to field parameters (such as temperature and EC). Two tracer tests were

performed injecting SF<sub>6</sub>, an inert gas, at a constant rate, and Br<sup>-</sup> (bromide), as a pulse injection, to estimate independently hyporheic zone parameters. The samples were collected in surface water and in the hyporheic zone by means of two nests of minipiezometers settled within the streambed, about 200 m downstream of the SF<sub>6</sub> injection point. Sediment samples were also collected in order to measure the radon production rate. Stream flow measurements were carried out at several sections.

The <sup>222</sup>Rn disequilibrium technique produced residence time estimates of water in the hyporheic zone ranging between <0.035 and 0.23 d (the minipiezometers average value was 0.095 ± 0.086 d). Bromide tracer injection and concentration monitoring between two parts of the stream, coupled with a one dimensional advection–dispersion model with transient storage, allowed for the indirect estimation of an average residence time of 0.10 ± 0.03 d, assuming that storage only occurred in the hyporheic zone. The SF<sub>6</sub> injection was modelled by means of Eqs (7–9), excluding the production and decay terms, and resulted in residence time estimates ranging from 0.05 to 0.2 d.

The hyporheic residence times estimated by <sup>222</sup>Rn data were consistent with results obtained using different methodologies, supporting the feasibility of this environmental tracer to study rapid exchange fluxes between the stream and hyporheic sediments.

This method can be also applied when regional groundwater discharges into a river or if a river recharges groundwater. The reader is referred to the Ref. [38] for a detailed description of the method. The great potential of this technique is its simplicity and ability to identify storage related to the hyporheic zone only, while most injected tracers identify a residence time which is an integration of surface and subsurface processes. Moreover, measurements *in situ* of hyporheic water residence times using <sup>222</sup>Rn disequilibrium can be also used to study the variability of hyporheic exchange processes in the study reach.

## 5. CONCLUDING REMARKS

Among isotope tracers, the natural occurring radioactive gas <sup>222</sup>Rn (radon) is worthy of note because it is a powerful tool to detect and quantify groundwater inputs to rivers, as well as to estimate the residence time of surface water within streambed sediments. The main advantages of using <sup>222</sup>Rn as a tracer of groundwater–surface water exchanges are that (i) <sup>222</sup>Rn occurs naturally in all groundwater systems, although its concentrations may vary considerably between aquifers, depending on lithology and geologic structure; (ii) its stream concentrations are usually several orders of magnitude lower than associated groundwater concentrations because of degassing; (iii) it is easy to sample and analyse. Since <sup>222</sup>Rn has a short half-life (3.8 days), its great potential lies in the study of rapid mixing processes, occurring on time scales from hours to several days. To study such rapid and dynamic processes, continuous or high frequency monitoring is suggested until it is clear how to adapt the sampling frequency to the dynamics of the studied system, and to take into account temporal variations of <sup>222</sup>Rn in groundwater. The main drawbacks are that <sup>222</sup>Rn is very sensitive to aquifer geolithologic characteristics and for this reason sometimes even over small distances great differences can be found of radon concentration in groundwater, making the definition of an equilibrium value difficult. However, an integrated approach to the study of river–groundwater interactions is always recommended to thoroughly comprehend the systems object of the study.

## ACKNOWLEDGEMENTS

Authors' acknowledgements go to S. Lamontagne for insightful comments to the final manuscript. Moreover, L. Stellato would like to thank F. Marzaioli for the enlightening discussions in the early stages of manuscript writing.

## REFERENCES

- [1] STELLATO, L., NEWMAN, B.D., "Groundwater inputs to rivers: hydrological, biogeochemical and ecological effects inferred by environmental isotopes", Application of Isotope Techniques for Assessing Nutrient Dynamics in River Basins, IAEA, Vienna (in preparation).
- [2] SCHUMANN, R.R., GUNDERSEN, L.C.S., Geologic and climatic controls on the radon emanation coefficient, *Environ. Inter.* **22** (1996) S439–S446.
- [3] KRAEMER, T.F., GENEREUX, D., "Applications of Uranium- and Thorium-series radionuclides in catchment hydrology studies", Isotope tracers in catchment hydrology (KENDALL, C., McDONNELL, J.J., Eds), Elsevier (1998) 679–722.
- [4] TOMMASINO, L., "Radon determination", Encyclopedia of analytical science, Academic Press (1995) 4359–4368.
- [5] HOEHN, E., VON GUNTEN, H.R., Radon in groundwater: A tool to assess infiltration from surface waters to aquifers, *Water Resour. Res.* **25** (1989) 1795–1803.
- [6] ELLINS, K.K., et al., Using  $^{222}\text{Rn}$  to examine groundwater/surface discharge interaction in the Rio Grande de Manati, Puerto Rico, *J. Hydrol.* **115** (1990) 319–341.
- [7] BERTIN, C., BOURG, A.C.M., Radon-222 and chloride as natural tracers of the infiltration of river water into an alluvial aquifer in which there is significant river/groundwater mixing, *Environ. Sci. Technol.* **28** (1994) 794–798.
- [8] ROGERS, A.S., Physical behaviour and geologic control of radon in mountain streams, U.S. Geological Survey, *Geol. Bull.* **1052-E** (1958).
- [9] LEE, R., HOLLYDAY, E.F., Radon measurements in stream to determine location and magnitude of ground-water seepage (GRAVES, B., Ed.), Radon, radium and other radioactivity in groundwater, Chelsea, Mich., Lewis Publishers, Inc. (1987) 241–249.
- [10] GENEREUX, D.P., HEMOND, H.F., Naturally occurring Radon 222 as a tracer for streamflow generation: steady-state methodology and field example, *Water Resour. Res.* **26** 12 (1990) 3065–3075.
- [11] LEE, R., HOLLYDAY, E.F., "Use of radon measurements in Carter's Creek, Maury County, Tennessee, to determine location and magnitude of groundwater seepage", Field studies of radon in rocks, soil and water, (GUNDERSEN, L.C., WANTY, R.B., Eds), C.K. Smoley, Boca Raton, Florida (1991) 237–242.
- [12] GENEREUX, D.P., et al, Use of radon-222 and calcium in a three-end-member mixing model for streamflow generation on the west fork of Walker Branch watershed, *J. Hydrol.* **142** (1993) 167–211.

- [13] COOK, P.G., et al., Determining natural groundwater influx to a tropical river using radon, chlorofluorocarbons and ionic environmental tracers, *J. Hydrol.* **227** (2003) 74–88.
- [14] LEWIS, W.K., WHITMAN, W.C., Principles of gas absorption, *Ind. Eng. Chem.* **17** 1215–1220 (1924).
- [15] ELSINGER, R.J., MOORE, W., Gas exchange in the Pee Dee river based on  $^{222}\text{Rn}$  evasion, *Geophys. Res. Lett.* **10** 443–446 (1984).
- [16] WILCOCK, R., et al., Characterization of lowland streams using a single station diurnal curve analysis model with continuous monitoring data for dissolved oxygen and temperature, *N. Z. J. Mar. Freshw. Res.* **32** (1998) 67–79.
- [17] WANNINKHOF, R., et al., Gas exchange rates for a first-order stream determined with deliberate and natural tracers, *Water Resour. Res.* **26** 7 (1990) 1621–1630.
- [18] GENEREUX, D.P., HEMOND, H.F., Determination of gas exchange rate constants for a small stream on Walker Branch Watershed, Tennessee, *Water Resour. Res.* **28** 9 (1992) 2365–2374.
- [19] STELLATO, L., et al., Comparison of three models of gas exchange to describe the degassing of  $^{222}\text{Rn}$  in a first-order stream on Huewelerbaach catchment (Luxembourg), EGU General Assembly, Vienna, Austria, April 16–20 (2007).
- [20] SURBECK, H., EISENLOHR, L., Radon as a tracer in hydrogeology; a case study *Environ. Geochem. Health* **16** suppl. (1993) 91–100.
- [21] HOFFMAN, et al., “Continuous  $^{222}\text{Rn}$  measurements in water to perform a hydrograph separation”, *Isotopes in the Hydrological Cycle and Environment — Abstracts, International Workshop on The Application of Isotope Techniques in Hydrological and Environmental Studies*, UNESCO, Paris, France, September 6–10 (2004).
- [22] STELLATO, L., et al., Some limitations in using  $^{222}\text{Rn}$  to assess river–groundwater interactions: the case of Castel di Sangro alluvial plain (Central Italy), *Hydrogeol. J.* **16** 4 (2008) 701–712.
- [23] COOK, P.G., et al., Quantifying groundwater discharge to streams using dissolved gas tracers  $^{222}\text{Rn}$  and  $\text{SF}_6$ , Cockburn River, Southeastern Australia, *Water Resour. Res.* **42** (2006) W10411.
- [24] LAMONTAGNE, S., COOK, P.G., Estimation of hyporheic water residence time in situ using  $^{222}\text{Rn}$  disequilibrium, *Limnol. Oceanogr.: Methods* **5** (2007) 407–416.
- [25] UNITED STATES ENVIRONMENTAL PROTECTION AGENCY, EERF Manual, 78–1. Radon in water sampling program (1978).
- [26] BELLONI, P., et al., Optimization and comparison of three different methods for the determination of  $\text{Rn-222}$  in water, *Sci. Total Environ.* **173/174** (1995) 61–67.
- [27] LEANEY, F., HERCZEG, A.L., A rapid field extraction method for determination of radon–222 in natural waters by scintillation counting, *Limnol. Oceanogr.: Methods.* **4** (2006) 254–259.

- [28] MOOK, W.G., “Introduction – Theory, Methods and Review”, Environmental isotopes in the hydrological cycle, Principle and applications, IAEA, Vol. I (2001) <http://www.iaea.org/programmes/ripc/ih/volumes/volume1.htm>.
- [29] SALONEN, L., “Measurements of low levels of  $^{222}\text{Rn}$  in water with different commercial liquid scintillation counters and pulse shape analysis”, Int. Conf. on Advances in Liquid Scintillation Spectrometry, September 14–18, Vienna (1992).
- [30] KLUGE, T., ILMBERGER, J., VON ROHDEN, C., AESCHBACH-HERTIG, W., Tracing and quantifying groundwater inflow into lakes using a simple method for radon-222 analysis, *Hydrol. Earth Syst. Sci.* **11** (2007) 1621–1631.
- [31] BURNETT, W.C., KIM, G., LANE-SMITH, D., A continuous monitor for assessment of  $^{222}\text{Rn}$  in the coastal ocean, *J. Radioanal. Nucl. Chem.* **249** (2001) 167–172.
- [32] DULAIIOVA, H., PETERSON, R., BURNETT, W.C., LANE-SMITH, D., A multi-detector continuous monitor for assessment of  $^{222}\text{Rn}$  in the coastal ocean, *J. Radioanal. Nucl. Chem.* **263** (2005) 361–365.
- [33] CENTRE DE RECHERCHE PUBLIC – GABRIEL LIPPMANN & UNIVERSITÉ DU LUXEMBOURG, CYCLEAU, Etude du cycle de l’eau dans le bassin de l’Attert, Final project report to the National Research Fund of Luxembourg, Centre de Recherche Public, Gabriel Lippmann, Université du Luxembourg, Belvaux, Grand-Duchy of Luxembourg (2006) 139.
- [34] DANCKWERTS, P.V., Significance of liquid-film coefficients in gas absorption, *Indust. Eng. Chem.* **43** (1951) 1460–1467.
- [35] O’CONNOR, D.J., DOBBINS, W.E., Mechanisms of reaeration in natural streams, *Trans. Am. Soc. Civil Eng.* **123** (1958) 641.
- [36] PENG, T.H., TAKAHASHI, T., BROEKER, W.S., Surface radon in the North Pacific station PAPA, *J. Geophys. Res.* **79** (1974) 1772–1780.
- [37] STELLATO, L., et al., Some limitations in using  $^{222}\text{Rn}$  to assess river–groundwater interactions: the case of Castel di Sangro alluvial plain (Central Italy), *Hydrogeol. J.* **16** 4 (2008) 701–712.
- [38] LAMONTAGNE, S., COOK, P.G., Estimation of hyporheic exchange in a subtropical stream using bromide and  $\text{SF}_6$  injection and  $^{222}\text{Rn}$  disequilibrium, CSIRO Land and Water Science Report 48/06, May 2006 (2006).





- McLaughlin, K. Southern California Coastal Water  
Research Project,  
3535 Harbor Blvd., Suite 110,  
Costa Mesa, CA 92626,  
USA  
Phone: +714 755 3242  
karenm@sccwrp.org
- Nagata, T. Marine Biogeochemistry Group,  
Atmosphere and Ocean Research Institute,  
The University of Tokyo,  
Kashiwanoha 5-1-5, Kashiwa,  
Chiba 277-8564  
Japan  
Tel. +81(0) 4 7136 6090  
Fax +81(0) 4 7136 6085  
nagata@ori.u-tokyo.ac.jp
- Ohte, N. Laboratory of Forest Hydrology  
& Erosion Control Engineering,  
Department of Forest Science,  
Graduate School of Agricultural  
& Life Sciences,  
The University of Tokyo,  
Tokyo, 113-8657,  
Japan  
Tel. +81 3 5841 5214  
Fax +81 3 5841 5464  
nobu@fr.a.u-tokyo.ac.jp
- Rogers, K. National Isotope Centre,  
GNS Science,  
PO Box 31-312,  
Lower Hutt,  
New Zealand  
Tel. +64 4 570 4636  
Fax +64 4 570 4657  
k.rogers@gns.cri.nz
- Stellato, L. Dipartimento di Scienze Ambientali,  
Seconda Università degli Studi di Napoli,  
Via Vivaldi 43,  
81100 Caserta  
Italy  
Tel. +39 3476037825  
Fax +39 0823 274605  
luisa.stellato@unina2.it

Widory, D.

Stable Isotope Laboratory,  
BRGM MMA/ISO  
3 avenue Claude Guillemin,  
BP 36009,  
45060 Orléans Cedex 2,  
France  
Tel. +33-(0)2 38 64 47 72  
Fax +33-(0)2 38 64 37 11  
d.widory@brgm.fr

Victoria, R.L.

Laboratorio de Ecologia,  
Centro de Energia Nuclear na Agricultura,  
Universidade de Sao Paulo (USP),  
Av. Centenario 303,  
13416-000 Piracicaba SP,  
Brazil  
Tel. +55 19 34294078  
Fax +55 19 34294610  
reyna@cena.usp.br





# Where to order IAEA publications

In the following countries IAEA publications may be purchased from the sources listed below, or from major local booksellers. Payment may be made in local currency or with UNESCO coupons.

## AUSTRALIA

DA Information Services, 648 Whitehorse Road, MITCHAM 3132  
Telephone: +61 3 9210 7777 • Fax: +61 3 9210 7788  
Email: [service@dadirect.com.au](mailto:service@dadirect.com.au) • Web site: <http://www.dadirect.com.au>

## BELGIUM

Jean de Lannoy, avenue du Roi 202, B-1190 Brussels  
Telephone: +32 2 538 43 08 • Fax: +32 2 538 08 41  
Email: [jean.de.lannoy@infoboard.be](mailto:jean.de.lannoy@infoboard.be) • Web site: <http://www.jean-de-lannoy.be>

## CANADA

Bernan Associates, 4501 Forbes Blvd, Suite 200, Lanham, MD 20706-4346, USA  
Telephone: 1-800-865-3457 • Fax: 1-800-865-3450  
Email: [customercare@bernan.com](mailto:customercare@bernan.com) • Web site: <http://www.bernan.com>

Renouf Publishing Company Ltd., 1-5369 Canotek Rd., Ottawa, Ontario, K1J 9J3  
Telephone: +613 745 2665 • Fax: +613 745 7660  
Email: [order.dept@renoufbooks.com](mailto:order.dept@renoufbooks.com) • Web site: <http://www.renoufbooks.com>

## CHINA

IAEA Publications in Chinese: China Nuclear Energy Industry Corporation, Translation Section, P.O. Box 2103, Beijing

## CZECH REPUBLIC

Suweco CZ, S.R.O., Klecakova 347, 180 21 Praha 9  
Telephone: +420 26603 5364 • Fax: +420 28482 1646  
Email: [nakup@suweco.cz](mailto:nakup@suweco.cz) • Web site: <http://www.suweco.cz>

## FINLAND

Akateeminen Kirjakauppa, PO BOX 128 (Keskuskatu 1), FIN-00101 Helsinki  
Telephone: +358 9 121 41 • Fax: +358 9 121 4450  
Email: [akatilaus@akateeminen.com](mailto:akatilaus@akateeminen.com) • Web site: <http://www.akateeminen.com>

## FRANCE

Form-Edit, 5, rue Janssen, P.O. Box 25, F-75921 Paris Cedex 19  
Telephone: +33 1 42 01 49 49 • Fax: +33 1 42 01 90 90  
Email: [formedit@formedit.fr](mailto:formedit@formedit.fr) • Web site: <http://www.formedit.fr>

Lavoisier SAS, 145 rue de Provigny, 94236 Cachan Cedex  
Telephone: + 33 1 47 40 67 02 • Fax +33 1 47 40 67 02  
Email: [romuald.verrier@lavoisier.fr](mailto:romuald.verrier@lavoisier.fr) • Web site: <http://www.lavoisier.fr>

## GERMANY

UNO-Verlag, Vertriebs- und Verlags GmbH, Am Hofgarten 10, D-53113 Bonn  
Telephone: + 49 228 94 90 20 • Fax: +49 228 94 90 20 or +49 228 94 90 222  
Email: [bestellung@uno-verlag.de](mailto:bestellung@uno-verlag.de) • Web site: <http://www.uno-verlag.de>

## HUNGARY

Librotrade Ltd., Book Import, P.O. Box 126, H-1656 Budapest  
Telephone: +36 1 257 7777 • Fax: +36 1 257 7472 • Email: [books@librotrade.hu](mailto:books@librotrade.hu)

## INDIA

Allied Publishers Group, 1st Floor, Dubash House, 15, J. N. Heredia Marg, Ballard Estate, Mumbai 400 001,  
Telephone: +91 22 22617926/27 • Fax: +91 22 22617928  
Email: [alliedpl@vsnl.com](mailto:alliedpl@vsnl.com) • Web site: <http://www.alliedpublishers.com>

Bookwell, 2/72, Nirankari Colony, Delhi 110009  
Telephone: +91 11 23268786, +91 11 23257264 • Fax: +91 11 23281315  
Email: [bookwell@vsnl.net](mailto:bookwell@vsnl.net)

## ITALY

Libreria Scientifica Dott. Lucio di Biasio "AEIOU", Via Coronelli 6, I-20146 Milan  
Telephone: +39 02 48 95 45 52 or 48 95 45 62 • Fax: +39 02 48 95 45 48  
Email: [info@libreriaaeiou.eu](mailto:info@libreriaaeiou.eu) • Website: [www.libreriaaeiou.eu](http://www.libreriaaeiou.eu)

## **JAPAN**

Maruzen Company Ltd, 1-9-18, Kaigan, Minato-ku, Tokyo, 105-0022  
Telephone: +81 3 6367 6079 • Fax: +81 3 6367 6207  
Email: journal@maruzen.co.jp • Web site: <http://www.maruzen.co.jp>

## **REPUBLIC OF KOREA**

KINS Inc., Information Business Dept. Samho Bldg. 2nd Floor, 275-1 Yang Jae-dong SeoCho-G, Seoul 137-130  
Telephone: +02 589 1740 • Fax: +02 589 1746 • Web site: <http://www.kins.re.kr>

## **NETHERLANDS**

De Lindeboom Internationale Publicaties B.V., M.A. de Ruyterstraat 20A, NL-7482 BZ Haaksbergen  
Telephone: +31 (0) 53 5740004 • Fax: +31 (0) 53 5729296  
Email: books@delindeboom.com • Web site: <http://www.delindeboom.com>

Martinus Nijhoff International, Koraalrood 50, P.O. Box 1853, 2700 CZ Zoetermeer  
Telephone: +31 793 684 400 • Fax: +31 793 615 698  
Email: info@nijhoff.nl • Web site: <http://www.nijhoff.nl>

Swets and Zeitlinger b.v., P.O. Box 830, 2160 SZ Lisse  
Telephone: +31 252 435 111 • Fax: +31 252 415 888  
Email: info@swets.nl • Web site: <http://www.swets.nl>

## **NEW ZEALAND**

DA Information Services, 648 Whitehorse Road, MITCHAM 3132, Australia  
Telephone: +61 3 9210 7777 • Fax: +61 3 9210 7788  
Email: service@dadirect.com.au • Web site: <http://www.dadirect.com.au>

## **SLOVENIA**

Cankarjeva Založba d.d., Kopitarjeva 2, SI-1512 Ljubljana  
Telephone: +386 1 432 31 44 • Fax: +386 1 230 14 35  
Email: import.books@cankarjeva-z.si • Web site: <http://www.cankarjeva-z.si/uvoz>

## **SPAIN**

Díaz de Santos, S.A., c/ Juan Bravo, 3A, E-28006 Madrid  
Telephone: +34 91 781 94 80 • Fax: +34 91 575 55 63  
Email: compras@diazdesantos.es, carmela@diazdesantos.es, barcelona@diazdesantos.es, julio@diazdesantos.es  
Web site: <http://www.diazdesantos.es>

## **UNITED KINGDOM**

The Stationery Office Ltd, International Sales Agency, PO Box 29, Norwich, NR3 1 GN  
Telephone (orders): +44 870 600 5552 • (enquiries): +44 207 873 8372 • Fax: +44 207 873 8203  
Email (orders): book.orders@tso.co.uk • (enquiries): book.enquiries@tso.co.uk • Web site: <http://www.tso.co.uk>

### **On-line orders**

DELTA Int. Book Wholesalers Ltd., 39 Alexandra Road, Addlestone, Surrey, KT15 2PQ  
Email: info@profbooks.com • Web site: <http://www.profbooks.com>

### **Books on the Environment**

Earthprint Ltd., P.O. Box 119, Stevenage SG1 4TP  
Telephone: +44 1438748111 • Fax: +44 1438748844  
Email: orders@earthprint.com • Web site: <http://www.earthprint.com>

## **UNITED NATIONS**

Dept. 1004, Room DC2-0853, First Avenue at 46th Street, New York, N.Y. 10017, USA  
(UN) Telephone: +800 253-9646 or +212 963-8302 • Fax: +212 963-3489  
Email: publications@un.org • Web site: <http://www.un.org>

## **UNITED STATES OF AMERICA**

Bernan Associates, 4501 Forbes Blvd., Suite 200, Lanham, MD 20706-4346  
Telephone: 1-800-865-3457 • Fax: 1-800-865-3450  
Email: customercare@bernan.com • Web site: <http://www.bernan.com>

Renouf Publishing Company Ltd., 812 Proctor Ave., Ogdensburg, NY, 13669  
Telephone: +888 551 7470 (toll-free) • Fax: +888 568 8546 (toll-free)  
Email: order.dept@renoufbooks.com • Web site: <http://www.renoufbooks.com>

**Orders and requests for information may also be addressed directly to:**

### **Marketing and Sales Unit, International Atomic Energy Agency**

Vienna International Centre, PO Box 100, 1400 Vienna, Austria  
Telephone: +43 1 2600 22529 (or 22530) • Fax: +43 1 2600 29302  
Email: sales.publications@iaea.org • Web site: <http://www.iaea.org/books>

INTERNATIONAL ATOMIC ENERGY AGENCY  
VIENNA  
ISBN 978-92-0-138810-0  
ISSN 1011-4289